

# **USER MANUAL**

## **POWER QUALITY ANALYZER**

### **PQM-707**





## **USER MANUAL**

# **POWER QUALITY ANALYZER PQM-707**



**SONEL S.A.  
Wokulskiego 11  
58-100 Świdnica, Poland**

Version 1.20.10 24.02.2026



# CONTENTS









<b>1</b>	<b>General information</b>	<b>6</b>
1.1	Safety	6
1.2	General characteristics	7
1.3	Power supply of the analyzer	8
1.4	Measured parameters	9
1.5	Compliance with standards	11
<b>2</b>	<b>Operation of the analyzer</b>	<b>12</b>
2.1	Switching the analyzer ON/OFF	12
2.2	Emergency restart	12
2.3	Emergency shutdown	12
2.4	Auto-off	13
2.5	LED	13
2.6	MicroSD memory card	13
2.7	USB external memory - pendrive	14
2.8	Main elements of the screen	14
2.8.1	Top bar	15
2.8.2	The title bar and help	15
2.8.3	Main window	15
2.8.4	Information bar on the parameters of the current mains configuration	16
2.8.5	Menu bar	16
2.9	Recording configuration	17
2.9.1	Recording configuration – General settings	20
2.9.2	Recording configuration – General settings II	22
2.9.3	Recording configuration – Voltage parameters	23
2.9.4	Recording configuration – Current parameters	25
2.9.5	Recording configuration – Powers	26
2.9.6	Recording configuration – Energy and power factors	27
2.9.7	Recording configuration – Flicker and unbalance	28
2.9.8	Recording configuration – THD, TDD and harmonics	29
2.9.9	Configuration default settings	30
2.9.10	Start / stop of recording	31
2.9.11	Approximate recording times	32
2.10	Analyzer settings	33
2.10.1	Analyzer settings – Hardware settings	33
2.10.2	Analyzer settings – Settings	34
2.10.3	Analyzer settings – Managers	36
2.11	Recording analysis	39
2.11.1	List of recordings	39
2.11.2	Recording summary window	40
2.11.3	Timeplots – selecting the time range	41
2.11.4	Timeplots – selecting data	43
2.11.5	Timeplots of parameters – timeplot window	45
2.11.6	Generating report on compliance with standard	47
2.11.7	Report according to standard - description	49
2.11.7.1	Section GENERAL INFORMATION	49
2.11.7.2	Section MEASUREMENT STATISTICS	50
2.11.7.3	Section FREQUENCY	51
2.11.7.4	Section VOLTAGE	52
2.11.7.5	Section PHASE-TO-PHASE VOLTAGE	52

2.11.7.6	Section FLICKER .....	52
2.11.7.7	Section UNBALANCE .....	52
2.11.7.8	Section HIGHER ORDER HARMONICS .....	53
2.11.7.9	Section HIGHER ORDER HARMONICS – ADDITIONAL INFORMATION .....	53
2.11.7.10	Section ADDITIONAL INFORMATION – EVENTS .....	53
2.11.7.11	Section ADDITIONAL INFORMATION – STATISTICS OF POLYPHASE EVENTS .....	53
2.11.7.12	Section ADDITIONAL INFORMATION .....	54
2.11.8	Harmonics graph .....	54
2.11.9	Event list .....	54
2.11.10	Energy cost calculator .....	58
2.11.10.1	Settings of the energy cost calculator .....	59
2.11.11	Generating report on compliance with standard NEC220.87 .....	61
2.12	Inrush current .....	63
2.12.1	Inrush current measurement configuration .....	63
2.12.2	Inrush current measurement and analysis .....	65
2.13	Measuring the efficiency of the inverter .....	69
2.13.1	Measurement configuration .....	69
2.13.2	Live mode .....	71
2.14	Energy losses calculator .....	73
2.14.1	Functional Description .....	73
2.14.2	Configuration of the loss calculator .....	74
2.15	About analyzer .....	76
2.16	LIVE mode of the network .....	76
2.16.1	Waveforms of voltages and currents .....	76
2.16.2	Timeplot of RMS values .....	78
2.16.3	Live mode – tabular view .....	79
2.16.4	Phasor diagram .....	81
2.16.5	Harmonics graph/table .....	82
2.17	Operation with PC .....	84
2.17.1	"Sonel Analysis" software .....	84
2.17.2	PC connection and data transmission .....	84
2.18	Wiring diagrams .....	85
2.18.1	Verifying the connection .....	90
2.19	Example of use .....	92
<b>3</b>	<b>Design and measurement methods .....</b>	<b>96</b>
3.1	Voltage inputs .....	96
3.2	Current inputs .....	96
3.3	Digital integrator .....	96
3.4	Signal sampling .....	97
3.5	PLL synchronization .....	97
3.6	Frequency measurement .....	97
3.7	Event detection .....	98
3.8	Methods of parameter's averaging .....	99
<b>4</b>	<b>Calculation formulas .....</b>	<b>100</b>
4.1	Single-phase network .....	100
4.2	Split-phase network .....	103
4.3	3-phase 4-wire network .....	104
4.4	3-phase 4-wire (no U L2) / 2 ½ - element network .....	106

4.5	3-phase 3-wire networks .....	107
<b>5</b>	<b>Technical specification .....</b>	<b>108</b>
5.1	Inputs .....	108
5.2	Sampling and real time clock .....	109
5.3	Measured parameters – accuracy, resolution and ranges .....	109
5.3.1	Reference conditions .....	109
5.3.2	Measurement uncertainty within rated temperature range .....	110
5.3.3	Voltage .....	110
5.3.4	Current .....	111
5.3.5	Frequency .....	111
5.3.6	Harmonics .....	111
5.3.7	Power and energy .....	112
5.3.8	Estimating the uncertainty of power and energy measurements .....	113
5.3.9	Flicker .....	115
5.3.10	Unbalance .....	115
5.4	Event detection – voltage and current RMS .....	115
5.4.1	Event detection hysteresis .....	115
5.5	Recording .....	116
5.6	Power supply .....	117
5.7	Supported mains types .....	117
5.8	Supported current probes .....	118
5.9	Communication .....	118
5.10	Environmental conditions and other technical data .....	118
5.11	Safety and electromagnetic compatibility .....	119
5.12	Standards .....	119
<b>6</b>	<b>Rechargeable battery .....</b>	<b>120</b>
6.1	General information .....	120
6.2	Replacing rechargeable batteries .....	120
<b>7</b>	<b>Cleaning and maintenance .....</b>	<b>121</b>
<b>8</b>	<b>Storage .....</b>	<b>121</b>
<b>9</b>	<b>Dismantling and disposal .....</b>	<b>121</b>
<b>10</b>	<b>Optional accessories .....</b>	<b>122</b>
<b>11</b>	<b>Positions of the meter's cover .....</b>	<b>123</b>
<b>12</b>	<b>Manufacturer .....</b>	<b>123</b>

# 1 General information

The following international symbols are used on the analyzer and in this manual:

	Warning; See explanation in manual		Functional earth terminal		Alternating voltage/ current
	Direct voltage/ current		Double Insulation (Protection Class)		Conforms to relevant European Union direc- tives (Conformité Européenne)
	Do not dispose of this product as un- sorted municipal waste		Recycling information		Conforms to relevant Australian standards

## 1.1 Safety



### Warning

To avoid electric shock or fire, you must observe the following guidelines:

- Before you proceed to operate the analyzer, acquaint yourself thoroughly with the present manual and observe the safety regulations and specifications provided by the producer.
- Any application that differs from those specified in the present manual may result in damage to the device and constitute a source of danger for the user.
- Analyzers must be operated only by appropriately qualified personnel with relevant certificates authorizing the personnel to perform works on electric systems. Operating the analyzer by unauthorized personnel may result in damage to the device and constitute a source of danger for the user.
- The device must not be used for networks and devices in areas with special conditions, e.g. fire-risk and explosive-risk areas.
- Before starting the work, check the analyzer, wires, current probes and other accessories for any sign of mechanical damage. Pay special attention to the connectors.
- It is unacceptable to operate the device when:
  - ⇒ it is damaged and completely or partially out of order,
  - ⇒ its cords and cables have damaged insulation,
  - ⇒ of the device and accessories mechanically damaged.
- Do not power the analyzer from sources other than those listed in this manual.
- Do not connect inputs of the analyzer to voltages higher than the rated values.
- PE input of the analyzer is used only for connecting local grounding. Do not connect this input to any voltage.
- Use accessories and probes with a suitable rating and measuring category for the tested circuit.
- Do not use current probes other than those listed in this manual.
- Use only double insulated and certified probes.
- Do not exceed the rated parameters of the lowest measurement category (CAT) of the used measurement set consisting of the analyzer, probes and accessories. The measurement category of the entire set is the same as of the component with the lowest measurement category.
- If possible, connect the analyzer to the de-energized circuits.

- **Opening the device socket plugs results in the loss of its tightness, leading to a possible damage in adverse weather conditions. It may also expose the user to the risk of electric shock.**
- **Do not handle or move the device while holding it only by its cables.**
- **Do not short battery pack terminals together.**
- **Do not disassembly the battery pack.**
- **Repairs may be performed only by an authorized service point.**

## 1.2 General characteristics

PQM-707 (Fig. 1) is a mobile, 3-phase Power Quality Analyzer, providing its users with features for measuring, analysing and recording parameters of 50/60 Hz power networks and power quality in accordance with the European Standard EN 50160 and other standards. The analyzer is made in class S, in accordance with the requirements of IEC 61000-4-30:2015.

Convenient operation is ensured by a 7-inch LCD with a resolution of 800x480 and a multi-point touch panel. It may be also operated using the attached stylus. The display provides the current view of network parameters (including waveforms, vectors, tables). The user interface includes a complete analyzer configuration (selection of parameters for data recording/logging) and an analysis of the recorded data (including time and harmonics diagrams, reports on compliance with standards).

The only two buttons are used to turn on the meter and start the data recording.

The analyzer is equipped with five banana voltage terminals marked as L1, L2, L3, N and PE. The range of voltages measured by four measuring channels is max.  $\pm 1150$  V. The use of external transducers enables the analyzer to be used in networks with higher voltages.

Four terminals for current probes allow user to connect several types of probes to measure currents. The terminals may be connected to the following probe types: flexible probes with nominal rating up to 6000 A and hard clamps. Also in case of current, the nominal range may be changed by using additional transformers. The analyzer automatically recognizes the type of connected probes (provided that they have letter A in their marking and that automatic probes are set in the recording configuration).

The device has a user-accessible microSD memory card with a capacity of 4 GB. The card is used for storing recorded data files, reports and screenshots. The meter also has an internal memory with a smaller capacity, which is used for storing configuration files, standard settings and other.

Recorded parameters are divided into groups that may be independently turned on/off for recording purposes and this solution facilitates the rational management of the space on the memory card. Parameters that are not recorded, leave more memory space for further measurements.

The meter is compatible with PC software *Sonel Analysis*, which also supports other analyzers produced by Sonel. In the current version, this software provides the current view of the measured network ("live" mode) and the analysis of recorded data.

The data may be read using the USB port (slot of B type to connect PC) or directly from a microSD card and inserting it to an external memory card reader.

In addition, the analyzer has a second USB port - type A, which may be used to connect an external memory stick. Using the interface of the analyzer, the user may transfer selected files to the memory stick (e.g. files with reports and settings).

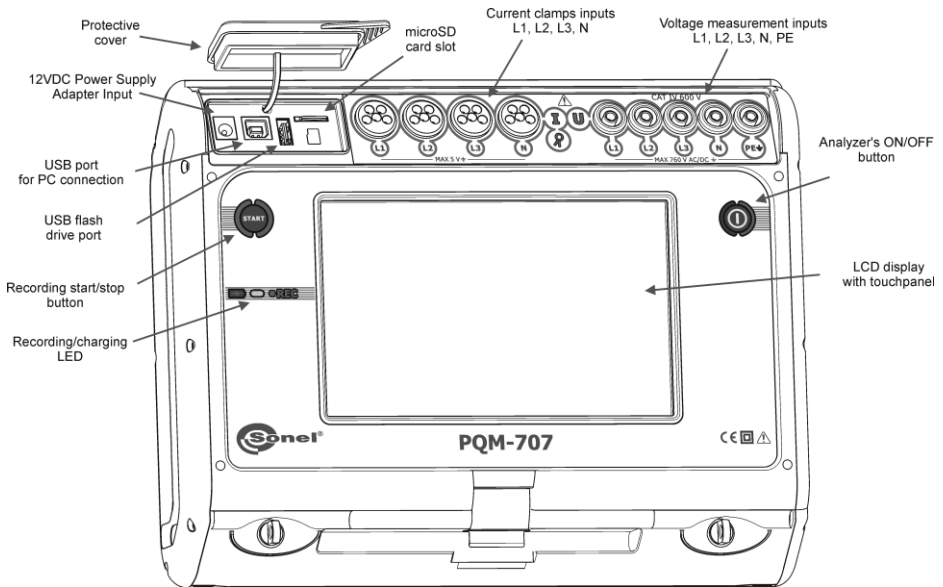

**Fig. 1. Power Quality Analyzer PQM-707. General view.**

### **1.3 Power supply of the analyzer**

The analyzer is powered from two sources: external power supply adapter (input voltage 100...240 V AC, output 12 V DC) and from a removable Li-Ion battery pack. The fully charged battery pack provides at least 4 hours of uninterrupted operation without an external power supply. After connecting the power supply the battery pack is recharged. Details are described in section 6 After the battery pack is discharged the meter stops its current operations (e.g. recording) and switches -off in the emergency mode. When the power supply from mains returns, the analyzer resumes interrupted recording.

Additional option for recharging the meter is connecting it with USB cable to a PC or charger with USB output. The charging current is then reduced accordingly (approx. 15-fold), which means that charging time is longer. This type of charging works only when the analyzer is completely switched off (not in sleep mode).

*Additional or new battery pack used for PQM-707 (Li-Ion 11.1 V, 3.4 Ah) may be purchased at our store or in Sonel distribution network.*

## 1.4 Measured parameters

The analyzer is designed to measure and record the following parameters:

- RMS voltages up to 760 VAC referred to PE input (measuring range up to  $\pm 1150$  V),
- RMS currents:
  - up to 6000 A (peak currents up to  $\pm 20$  kA) using flexible probes,
  - up to 1400 A using hard clamps,
- crest factors for current and voltage,
- mains frequency within the range of 40..70 Hz,
- active, reactive and apparent power and energy, distortion power,
- harmonics of voltages and currents (up to 50th),
- active and reactive powers of harmonics,
- Total Harmonic Distortion  $THD_F$  for current and voltage,
- Total Demand Distortion TDD for current,
- power factor PF,  $\cos\phi$ ,  $\tan\phi$ ,
- unbalance factors for three-phase mains and symmetrical components,
- flicker severity  $P_{ST}$  and  $P_{LT}$ ,

Some of the parameters are aggregated (averaged) according to the time selected by the user (available settings: 1s, 3s, 10s, 30s, 1min, 10min, 15min, 30min) and may be stored on a memory card. In addition to average value, it is also possible to record minimum and maximum values in individual averaging periods.

The analyzer detects the following types of voltage events: dip, swell and interruption. User may define two thresholds for current: exceeding (top value) of the maximum value and dropping below (bottom value) the minimum value. The current in the neutral channel has two independent thresholds. In DC systems, there are two thresholds: exceeding the maximum and minimum voltage value.

Event detection may be accompanied by recording waveforms of voltage and current waveforms and RMS values. These waveforms are recorded at the beginning and end of the event.

Tab. 1 presents a summary of parameters measured by PQM-707, depending on the mains type.

**Tab. 1. Measured parameters for different network configurations.**

Parameter \ Mains type, channel		1-phase		2-phase			3-phase 4-wire, 2 1/2 - element				3-phase 3-wire, 2-element			DC	DC+M				
		L1	N	L1	L2	N	Σ	L1	L2	L3	N	Σ	L12	L23	L31	Σ	L1	L2	Σ
U	RMS voltage	•	•	•	•	•		•	•	•	•	•	•	•					
U <sub>DC</sub>	DC voltage	•	•	•	•	•		•	•	•	•	•	•	•		•	•	•	
I	RMS current	•	•	•	•	•		•	•	•	•	•	•	•					
I <sub>DC</sub>	DC current	•	•	•	•	•		•	•	•	•	•	•	•		•	•	•	
F	Frequency	•		•				•					•						
CF U	Voltage crest factor	•	•	•	•	•		•	•	•	•	•	•	•					
CF I	Current crest factor	•	•	•	•	•		•	•	•	•	•	•	•					
P	Active power	•		•	•		•	•	•	•	•	•	•	•	•	•	•	•	•
Q <sub>T</sub> , Q <sub>B</sub>	Reactive power	•		•	•		•	•	•	•	•	•	•	•	•	• <sup>(1)</sup>			
D, S <sub>N</sub>	Distortion power	•		•	•		•	•	•	•	•	•	•	•					
S	Apparent power	•		•	•		•	•	•	•	•	•	•	•	•	•			
PF	Power Factor	•		•	•		•	•	•	•	•	•	•	•	•	•			
cosφ	Displacement power factor	•		•	•		•	•	•	•	•	•	•	•					
tanφ	Factor tangent φ	•		•	•		•	•	•	•	•	•	•	•	•	• <sup>(1)</sup>			
THD U	Total harmonic distortion voltage	•	•	•	•	•		•	•	•	•	•	•	•					
THD I	Total harmonic distortion current	•	•	•	•	•		•	•	•	•	•	•	•					
E <sub>P+</sub> , E <sub>P-</sub>	Active energy (consumed and supplied)	•		•	•		•	•	•	•	•	•	•	•	•	• <sup>(2)</sup>	• <sup>(2)</sup>	• <sup>(2)</sup>	• <sup>(2)</sup>
E <sub>Q1+</sub> , E <sub>Q1-</sub> , E <sub>Q3+</sub> , E <sub>Q3-</sub>	Reactive energy (consumed and supplied)	•		•	•		•	•	•	•	•	•	•	•	•	• <sup>(1)</sup>			
E <sub>S</sub>	Apparent energy	•		•	•		•	•	•	•	•	•	•	•	•	•			
U <sub>h1..Uh50</sub>	Voltage harmonic amplitudes	•	•	•	•	•		•	•	•	•	•	•	•					
I <sub>h1..Ih50</sub>	Current harmonic amplitudes	•	•	•	•	•		•	•	•	•	•	•	•					
P <sub>h1..Ph50</sub>	harmonics active power	•		•	•		•	•	•	•	•	•	•	•					
Q <sub>h1..Qh50</sub>	harmonics reactive power	•		•	•		•	•	•	•	•	•	•	•					
Unbalance U, I	Symmetrical components and unbalance factors											•			•				
P <sub>ST</sub> , P <sub>LT</sub>	Flicker severity	•		•	•		•	•	•	•	•	•	•	•					
TDD	Total demand distortion	•	•	•	•	•		•	•	•	•	•	•	•					

**Explanations:** L1, L2, L3 (L12, L23, L31) indicate subsequent phases,  
 N is a measurement for voltage channel N-PE or current channel I<sub>N</sub>, depending on the parameter type,  
 Σ is the total value for the system.

- (1) In 3-wire networks, the total reactive power is calculated as inactive power  $N = \sqrt{S_0^2 - P^2}$  (see discussion on reactive power in Power Quality Guide document)
- (2) Only consumed energy E<sub>P+</sub>

## 1.5 Compliance with standards

The analyzer is designed to meet the requirements of the following standards.

Standards valid for measuring network parameters:

- IEC 61000-4-30:2015 – Electromagnetic compatibility (EMC) - Testing and measurement techniques - Power quality measurement methods.
- IEC 61000-4-7:2007 – Electromagnetic compatibility (EMC) – Testing and Measurement Techniques - General Guide on Harmonics and Interharmonics Measurements and Instrumentation for Power Supply Systems and Equipment Connected to them.
- IEC 61000-4-15:2011 – Electromagnetic compatibility (EMC) – Testing and Measurement Techniques - Flickermeter - Functional and Design Specifications.
- IEC 50160:2010 – Voltage characteristics of electricity supplied by public distribution networks.

Safety standards:

- IEC 61010-1 – Safety requirements for electrical equipment for measurement control and laboratory use. Part 1: General requirements.
- IEC 61010-2-030 – Safety requirements for electrical equipment for measurement, control, and laboratory use - Part 2-030: Particular requirements for testing and measuring circuits.

Standards for electromagnetic compatibility:

- IEC 61326 – Electrical equipment for measurement, control and laboratory use. Requirements for electromagnetic compatibility (EMC).

The device meets all the requirements of Class S as defined in IEC 61000-4-30. The summary of the requirements is presented in the table below.

**Tab. 2. Summary of selected parameters in terms of their compliance with the standards**

Aggregation of measurements at different intervals	IEC 61000-4-30 Class S: <ul style="list-style-type: none"> <li>• Basic measurement time for parameters (voltage, current, harmonics, unbalance) is a 10-period interval for 50 Hz power supply system and 12-period interval for 60 Hz system,</li> <li>• Interval of 3 s (150 periods for the nominal frequency of 50 Hz and 180 periods for 60 Hz),</li> <li>• Interval of 10 minutes,</li> <li>• Interval of 2 h (basing on 12 intervals of 10 min.)</li> </ul>
Real-time clock (RTC) uncertainty	IEC 61000-4-30 Class S: <ul style="list-style-type: none"> <li>• Built-in real time clock with accuracy better than <math>\pm 5 \text{ s} / 24 \text{ h}</math>.</li> </ul>
Frequency	Compliant with IEC 61000-4-30 Class S of the measurement method and uncertainty
Power supply voltage	Compliant with IEC 61000-4-30 Class S of the measurement method and uncertainty
Voltage fluctuations (flicker)	The measurement method and uncertainty meets the requirements of IEC 61000-4-15 standard.
Dips, interruptions and surges of supply voltage	Compliant with IEC 61000-4-30 Class S of the measurement method and uncertainty
Supply voltage unbalance	Compliant with IEC 61000-4-30 Class S of the measurement method and uncertainty
Voltage and current harmonics	Compliant with IEC 61000-4-30 Class S of the measurement method and uncertainty (IEC 61000-4-7 class II)

## 2 Operation of the analyzer

### 2.1 Switching the analyzer ON/OFF

The analyzer may be switched-on by pressing button . Starting the meter from the completely inactivated status takes about thirty seconds. The screen displays the version of the software and the boot-up progress is indicated by a bar at the bottom part of the screen. After boot-up, the meter enters normal operation mode and displays the initial screen, which may be specified by the user. The default start-up screen is shown in Fig. 2.

The analyzer may be turned off by pressing button  (if recording is not active). A window will be displayed, where the user selects the mode for switching the meter off:

- **SHUTDOWN** – complete inactivation with minimum power consumption. Selecting this option ends the meter operation and then turns it off. Restarting the meter switched off in this way will take about thirty seconds. The advantage of this mode is the ability a long-term storage of the meter in the off state, without significant discharging of its battery pack.
- **SUSPEND** – stand-by of the meter. This mode allows user to quickly start the meter, but at the cost of increased power consumption from the battery pack. The battery pack in this state will be completely discharged in approx. 40 hours. After exceeding the critical level of discharging, the meter automatically switches off completely (see the option above).

In some situations, turning off the meter is locked:



- If the analyzer is recording, the user will see a message that recording is in progress. To switch the analyzer off, first stop the recording.
- When the analyzer performs processes that can not be interrupted, e.g. software update. In this case, wait until the meter goes into standby mode.

### 2.2 Emergency restart

If the analyzer stops to respond, it may be forced to **restart**. This procedure will not delete any settings or personal information.

If the emergency restart occurs while recording is in progress, the recording will be suspended until the device is restarted.

How to force the analyzer to restart?

- Press and hold button  until the device turns off and on again.
- When the startup screen appears (approx. 15 seconds from pressing ) release the button.

### 2.3 Emergency shutdown

If the analyzer stops responding, the user may perform emergency **shutdown**. Performing this action will not delete any personal information or user settings, but the date and time in the device will reset.

Performing an emergency shutdown during the recording will stop it until the device is restarted. When the device is turned on again, the recording process will continue and its results will be saved to **xxx\_part2** file, where **xxx** is the name of the recording that was in progress before the shutdown. For an emergency shutdown, the battery must be **removed from the device, as described in sec. 6.2**.

It is strongly recommended to avoid an emergency shutdown of the device, as it may damage the file where the recording is in progress or damage the device while updating its firmware.

## 2.4 Auto-off

The user can enable the option to automatically switching off the meter after 10 or 30-minutes of inactivity (see sec. 2.10.2). If the analyzer during this time is powered from the battery pack and is not in the recording mode and when connection to PC is inactive, it automatically switches when it is not used to save energy.

The analyzer turns off automatically also when the battery is fully discharged. Such emergency shut-down is performed regardless of the mode of the device. In case of active recording, it will be interrupted. When the power supply returns, the recording process is resumed. Emergency shut-down is signalled by an appropriate message.

## 2.5 LED

Two-colour LED located below  (START) button indicates the recording status and charge status of the battery pack.

Red colour indicates the recording process:

- LED flashes red during data recording, with a frequency of 0.5 Hz (once every 2 seconds)
- LED is inactive when recording is off.

Green colour indicates the battery pack:

- LED is continuously green during charging and when recording is off (also when the meter is switched off)
- during charging, but when the recording is on, green LED turns on once every 10 seconds.
- it flashes at 0.5 Hz frequency after charging error is detected (exceeded temperature, no battery pack); at the same time when recording is on red and green LED's flash alternately. When green LED flashes for a long time, even when the ambient temperature is correct and the battery pack temperature is within the range from 0°C to 45°C, it may indicate a faulty battery pack and the need to contact the manufacturer's service.

## 2.6 MicroSD memory card

Removable microSD HC card is the primary place of data storage for:

- recorded measurement data,
- standard compliance reports,
- screenshot files.

The top bar shows the status of the card and its free space available.

To ensure proper operation of the analyzer and prevent data loss:

- do not remove the memory card during recording. Ignoring this recommendation may result in ending the recording process, damage of data recorded, and in some cases, damage to the entire structure of files saved on the card.
- do not modify or delete files stored on the card or store own files on it. If the analyzer after inserting the card detects an error in the file system, the memory format panel is shown to perform formatting of the card. Only after formatting (which removes all files) it will be possible to reuse the card in the analyzer.
- Before removing the card from the meter (e.g. to read the data by *Sonel Analysis* by using external card reader) it is recommended to turn the meter off, to save all cached data.

MicroSD memory card may be formatted from the user interface level. Enter **ANALYZER SETTINGS** and select **MEMORY**, where the user may ability to format the memory (see also sec. 2.10.1).

## 2.7 USB external memory - pendrive

Connecting an external USB stick allows user to:

- copy selected files with reports on standard compliance from microSD memory card to the memory stick,
- copy selected files with screenshot from microSD memory card to the memory stick,
- save the log file of the meter, in case of an error in the analyzer in order to perform an analysis in the service department of the manufacturer,
- update the firmware of the analyzer. For this purpose, first save in the root folder of the memory stick the update file downloaded from the manufacturer's website <http://www.sonel.pl/en/download/firmware.html> (after extracting the ZIP archive). After inserting the USB memory to the analyzer, select from the main menu **ANALYZER SETTINGS** and then **UPGRADES**. When correct update files are detected, the appropriate window is displayed. The user should follow the on-screen prompts.

Supported file systems are FAT and FAT32. When a memory formatted in a different file system is inserted, the device will display a window informing about detecting unformatted media carrier. From this window, the user may directly enter the formatting screen. The data on the memory stick are stored in the folder named "PQM-707\_DATA".

## 2.8 Main elements of the screen

Fig. 2 shows the default screen of the analyzer after switching on. There you can distinguish several sections:

- top bar **1**,
- the title and help bar **2**,
- main window **3**,
- information bar on current mains configuration **4**,
- menu bar **5**.

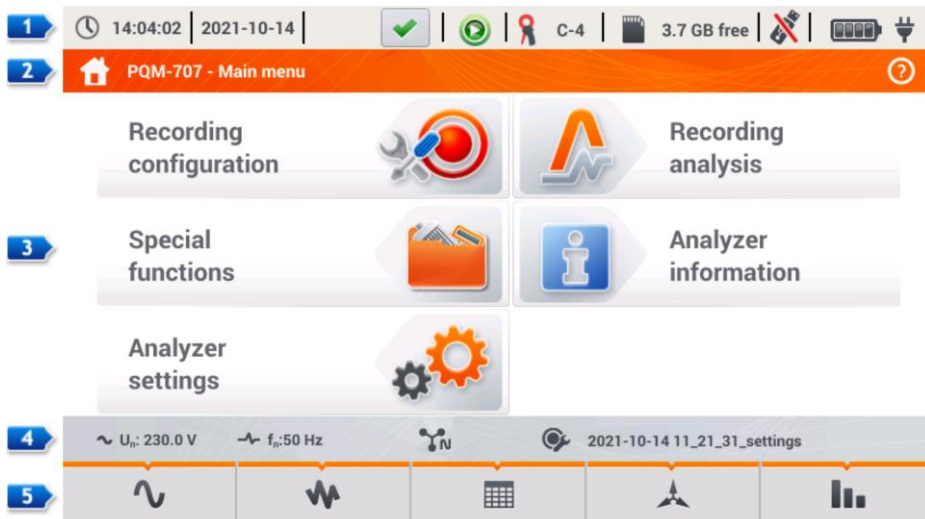

Fig. 2. Main elements of the analyzer screen.

### 2.8.1 Top bar

Top bar (Fig. 3) includes from left to right:



Fig. 3. Elements of the top bar.

- Current time and date of the analyzer **1**.
- Button of **HOLD** **2** function. Pressing this icon on the screens of LIVE mode (preview of the current network, see sec. 2.16) will stop the refreshing of image displayed in the main window. Press it again to return to normal mode.
- The button signalling the correct connection of the analyzer **3**. The icon on this button informs the user about the correctness or potential problem with the configuration or connection of the analyzer. Pressing this icon (it may show symbol **✓**, **?** or **✗**) will display a window with more detailed information about possible errors in connecting the analyzer to the mains and with the compliance of mains parameters with the measurement configuration. More information can be found in section 2.18.1.
- Recording status icon **4**. The icon is green when recording is inactive. After starting the recording of the icon turns red.
- Information on connected or configured current probes **5**. If the measurement configuration has no probes indicated - the field displays dashes "----". When a specific type of probes is selected, their name will be displayed. In the mode of auto detection of probes, the device displays the name of recognized probes (probe must be of the same type used in all measurement channels) or the question mark "?" if no probes are connected (or detected).
- Memory card icon with information about free space **6**. If the card is not in the slot, the screen shows the icon crossed out.
- External USB memory icon (USB stick) **7**. If no external memory is connected, the icon is crossed out.
- The icon of battery charge status and external power supply **8**.

### 2.8.2 The title bar and help

The title bar (Fig. 2, element **2**) displays the name of the current main window with the name of the section. It allows user to quickly see which part of the interface is displayed. The right side of the screen displays the Help icon **?**. After clicking it, a context help is displayed, which describes interface elements visible on the screen.

### 2.8.3 Main window

In the central part of the screen, the main window of the analyzer is displayed. The default window (shown in Fig. 2) contains four items:

- **RECORDING CONFIGURATION**. This part of the interface is used to configure the measurement system and all aspects related to the recording of network parameters such as: mains type (e.g. single-phase, three-phase), probes type, transformers, recorded parameters.
- **RECORDING ANALYSIS** – provides an analysis of the recorded data and "live" view of the recording process.
- **SPECIAL FUNCTIONS** including:
  - **INRUSH** – after selecting this option, the analyzer switches to inrush measurement mode (see section 2.12),
  - **INVERTER EFFICIENCY** (see section 2.13).

- **ENERGY LOSSES CALCULATOR** (see section 2.14).
- **ANALYZER SETTINGS** – its includes a range of analyzer configuration options, such as date and time, managing energy saving modes, or standards and files manager.
- **ANALYZER INFORMATION** – after selecting this option, a window is displayed with the details of the analyzer and manufacturer.







A more detailed description of each section is presented in the following chapters.

### 2.8.4 Information bar on the parameters of the current mains configuration

Below the main screen a bar is displayed, which shows the main parameters of the active measurement system (Fig. 2, element **4**):

- nominal voltage,
- mains frequency,
- mains type,
- the name of the current recording configuration.





The mains type is symbolized by icons:

-  - 1-phase system,
-  - split-phase system,
-  - 3-phase 4-wire system,  
- 3-phase 4-wire (no U L2) / 2 ½ element (no V L2/B),  
- transducers: 3-phase 4-wire,
-  - 3-phase 3-wire system,  
- 3-phase open delta,  
- transducers: 3-phase 3-wire,
-  - 3-phase 3-wire Aron / 2-elements,  
- transducers: 3-phase 3-wire Aron (2 PTs, 2-Elements)
-  - DC system,
-  - DC+M system.

### 2.8.5 Menu bar

The menu bar is displayed at the bottom of the screen (Fig. 2, element **5**). It usually contains several touch icons which change depending on the current context. The individual icons are described in sections presenting individual screens. In some cases, an additional menu bar is opened above the main menu bar.

Some icons displayed in the menu bar have a permanent effect throughout the interface:

-  - return to the main screen,
-  - return to the previous screen.
-  - saving a screenshot to an image file on microSD memory card,
-  - opening an additional zoom in/out menu for the chart.

In subsequent sections, the menu bar icons (and their effects), specific for a given view, are described in a separate part of entitled "Menu bar functions".

## 2.9 Recording configuration

Before any measurement is started it is necessary to properly configure the analyzer in accordance with the requirements of the user. Configuration changes are performed directly in the analyzer and it is (at the moment) the only possible way to configure the device - *Sonel Analysis* software in its current version (4.3.0) does not support the configuration of PQM-707 analyzer.

To access the configuration module on the main screen, select section **RECORDING CONFIGURATION**. The list is displayed with measurement configurations saved in the analyzer's memory (Fig. 4).

Type	Name	Size	Date
	2021-10-14 11_21_31_settings	2.0 KB	2021-10-14 11:38:17
	2020-12-04 14_57_19_settings	2.0 KB	2020-12-04 15:02:44
	2021-03-24 12_21_45_settings	2.0 KB	2021-03-24 12:22:08
	2021-03-24 12_25_17_settings	2.0 KB	2021-03-24 12:26:43
	2021-04-12 11_35_29_settings	2.0 KB	2021-04-12 11:39:32
	2021-10-14 11_18_50_settings	2.0 KB	2021-10-14 11:20:15

Fig. 4. Recording configuration – Configuration list.

The table has three columns:



- **TYPE** – displayed icon determines the type of measurement configuration:
  - - recording acc. to user configuration (inactive - grey)
  - - recording acc. to user configuration (active - green)
  - - recording for compliance with the selected standard (inactive)
  - - recording for compliance with the selected standard (active)
- **NAME** – the name of the configuration given by the user.
- **DATE** – date and time of creating the configuration.

The list may be scrolled in the window by finger icon or using the bar on the right.

### Menu bar functions

To make the desired configuration active, click its line, and then on the bottom bar select icon  (activate the configuration).

To modify the indicated configuration, in the bottom bar select icon  (editing) or double-click the line of this configuration.

Selecting the filter icon  activates an additional menu bar displayed above the main menu bar, where you may indicate which registrations are listed: acc. to user configuration, acc. to a standard, or both types. Selecting a given type is indicated by orange colour e.g. .

To add a new configuration, select icon  (add).

After clicking the icon for adding a new configuration, a window will be displayed as shown in Fig. 5. The title bar will display the default name of the new configuration. It is created from current date and time in the format "YYYY-MM-DD hh\_mm\_ss\_settings", which may be modified. An asterisk after the name indicates that the configuration has been modified but not saved.

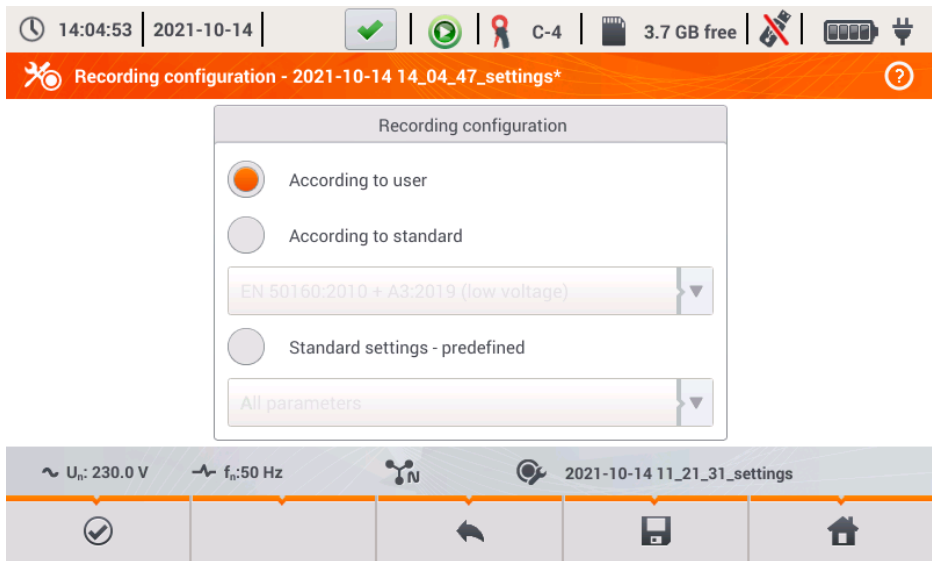

Fig. 5. Recording configuration – selecting the type of a new configuration.

The first step in creating a new configuration is selecting the type of a new configuration. There are two possibilities:

- **ACCORDING TO USER** – the user decides fully on recording character, averaging time and type of parameters to be recorded.
- **ACCORDING TO STANDARD** – recording for the compliance of the tested mains with the standard selected from the list; it enables user to generate a compliance report. The user may set only certain recording parameters, e.g. network layout and nominal voltage; other parameters are set automatically in accordance with the requirements of the selected standard (unchangeable). By default the analyzer has the following profiles prepared:
  - EN50160: European standard in three variants depending on the nominal voltage value (low, medium and high)
  - *Regulation of the Minister of Economy*: provisions valid in Poland in four variants depending on the nominal voltage value (low, medium, high 110 kV and 220 kV, high 400 kV)
  - Two variants of an Australian Standard (based on EN 50160 and AS 61000.3.100), for low and medium voltage,
  - GOST 32144-2013: Russian standard in four variants depending on the nominal voltage value (low, medium 6-20 kV, medium 35 kV, high),
  - NEC220.87 – 30-day Load Studies.
- **STANDARD SETTINGS – PREDEFINED** – list of five predefined settings the user can choose in order to speed up the process of complete setup. User needs to decide on the type of mains and averaging period etc. List of available settings:
  - All parameters
  - Logging: V, I, f and THD
  - Power study & Energy audit
  - Logging: harmonics, V, I
  - Power Quality
  - Load Study

### Menu bar functions



- approving the selected recording type and entering detailed edition.



- saving configuration with default parameters. The user will be asked for the name of the configuration file. You can save the configuration with the default name, created automatically, or change the name as desired.

Detailed configuration settings are divided into eight screens:

- **GENERAL SETTINGS,**
- **GENERAL SETTINGS II,**
- **VOLTAGE PARAMETERS,**
- **CURRENT PARAMETERS,**
- **POWERS,**
- **ENERGY AND POWER FACTORS,**
- **FLICKER AND UNBALANCE,**
- **THD, TDD AND HARMONICS,**
- **HARMONICS POWER.**

Buttons and at the bottom menu bar are used to switch between successive screens.

After editing the configuration you can save it under a certain name in the internal memory of the analyzer

by clicking icon . A window will be displayed, in which the user may to give the configuration a name (or leave the proposed one). To edit the name, click its area - a window with on-screen keyboard will appear. Field **Set as active** will set the saved configuration as active - the analyzer reads all settings and will be ready to start recording. To confirm, click **OK**, to cancel – **CANCEL**.

## 2.9.1 Recording configuration – General settings

Screen of General settings is shown in Fig. 6.

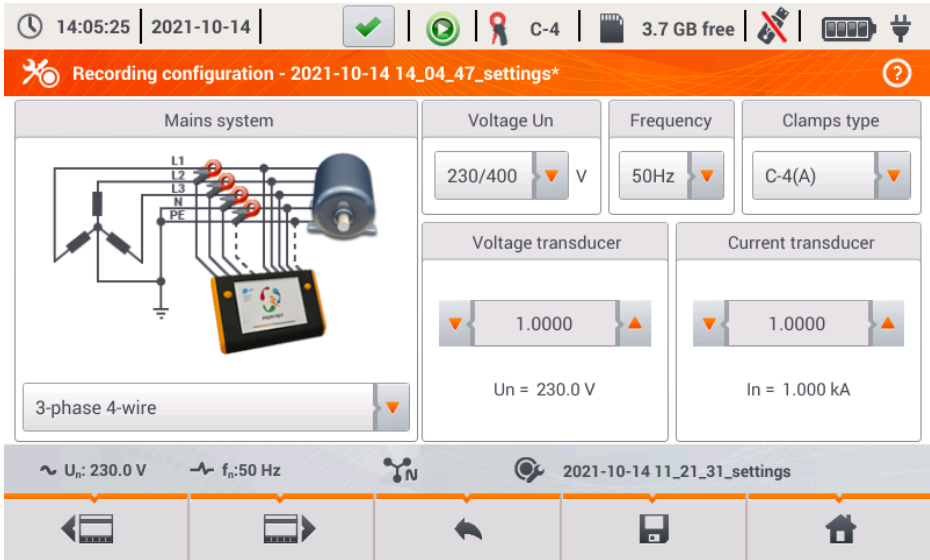

**Fig. 6. Recording configuration – General settings**

At this point, you may define:

- **MAINS TYPE.** By clicking the icon from drop-down list, or on the network name, you can select the following types (the names may differ depending on the language selected – US or GB):
  - 1-phase,
  - Split-phase,
  - 3-phase 4-wire (systems with neutral wire, e.g. wye with N),
  - 3-phase 3-wire (systems without neutral wire – wye without N and delta),
  - 3-phase 3-wire Aron / 2 element (as standard 3-wire system, but with the current measurement using two probes (I1 and I3), the third current (I2) is calculated according to the calculation method from the formula  $I2 = -(I1+I3)$  )
  - 3-phase 4-wire (no U L2) / 2 ½ element (no V L2/B) (as standard 4-wire system, but with the calculation of U L2 voltage (U L2 voltage is not measured) according to the formula  $UL2 = -(UL1+UL3)$  ).
  - 3-phase open delta,
  - Transducers: 3-phase 4-wire,
  - Transducers: 3-phase 3-wire,
  - Transducers: 3-phase (V system, Aron).

The above types of mains are available for frequencies of 50 and 60 Hz.

In DC systems, there are two systems of networks:

- DC – measuring one DC voltage and one DC current,
- DC+M – measuring two DC voltages in relation to the middle potential (M stands for *middle*), with the option for measuring two DC currents (probes C-5 or C-5A).
- **VOLTAGE UN** – the user may select from a list the nominal voltage of the tested network. Each entry in the list contains two values separated by slash, e.g. 230/400. The first of them specifies the nominal phase voltage in systems with neutral conductor (1-phase, split-phase, 3-phase

4-wire). The second value determines the phase-to-phase voltage in such systems and nominal phase-to-phase voltage in systems without neutral conductor (3-phase 3-wire)

- **FREQUENCY FN** – mains nominal frequency. There are three positions:
  - **50 Hz**,
  - **60 Hz**,
  - **DC** – selecting this option allows the measurement in DC systems (mains types: DC and DC+M described above).
- **PROBES TYPE** - here you can enable or disable the measurement of currents and determine the type of probes. If the current measurement is required, indicate probes to be used from the following list:
  - **F-x** – flexible probes (Rogowski coil) with a nominal range of 3000 A, AC measurement,
  - **C-4** – probes CT (with core) with a range of 1000 A for AC currents measurement,
  - **C-5** – probes with Hall sensor with a range of 1000 A for measuring AC and DC currents (only probes available in DC circuits),
  - **C-6** – probes CT (with core) with a range of 12 A for AC measurement,
  - **C-7** – probes CT (with core) with a range of 100 A for AC measurement,
  - **AUTO** – selecting this item allows you to use any automatic probe (the letter A in the designation, e.g. F-3A). The analyzer displays the type of connected probes on the top bar. Starting the recording is possible only when the analyzer recognized properly connected probes, and when the types of probes in multiphase systems are identical.
  - **NONE** – indicating this option turns off the current measurement and all the parameters that need the current measure (i.e. power).

When from **FREQUENCY FN** list **DC** position is selected, then only the following options are available: **None**, **C-5**, **Auto** (in **Auto** mode only C-5A probes are accepted).

- **VOLTAGE TRANSDUCER** – allows you to enter a multiplier of the nominal voltage selected from the list. The value of the multiplier may be set in the range from 0.1 to 10000.0 in 0.0001 steps. Multipliers are set in situations when using the external voltage transformers that modify the actual mains voltage to another voltage (usually lower), acceptable to the measuring instrument. Below the multiplier value, the screen displays resulting nominal voltage, which is the product of the multiplier and the nominal voltage indicated on the selection list. For example, when measuring the medium voltage of 15 kV (3-phase, 3-wire system) transformers are used to lower the ratio of 150:1. Voltage of 15 kV is transformed to 100 V, which may be safely provided to the input of the analyzer. In order to ensure that the measuring device indicates the factual voltage in a medium voltage network, it is necessary to set the voltage transformer at 150.0, and choose "58/100" from the list of nominal voltages. Voltage 100 V provided to the analyzer input will be multiplied by 150 and will be shown as 15 kV.
- **CURRENT TRANSDUCER** - provides the current multiplier measured by the current probes. The value of the multiplier can be set in the range of from 0.1 to 10000.0, in 0.0001 steps. When using external current transformers (usually reducing the current value) this field has to be provided with the same value as the transformer ratio. The currents measured by the probes will be multiplied by the transducer factor to reflect the actual currents flowing on the primary side of the transformer. Below the multiplier value, the resulting new value of the maximum current on the primary side is displayed, which is the product of the multiplier and the nominal range of probes used. For example, using the transformer of 10 000 A / 5 A and a probes C-6(A) (with nominal range of 12 A) you may measure currents up to 10 000 A (the limitation results from abilities of the transducer, not probes - primary current corresponding to the nominal current of the probes is 20 000 A).

## 2.9.2 Recording configuration – General settings II

Screen of General settings II is shown in Fig. 7. It consists of the following fields:

- **TRIGGERING**: specifies the method of starting the recording.
  - **Immediate** – starts recording after pressing *START*,
  - **Threshold** – device is ready for recording after pressing *START* button, but saving data to the memory card begins when the specified threshold of any event is exceeded, e.g. after detecting the first voltage dip. When analyzer waits for the first event to occur the recording state icon on the top bar changes to .
  - **Schedule** – start and end times of recording are defined by the user. The user may define only the start time (then the end will be triggered manually using a button), or only the end time (then the recording will be triggered manually by button) or both of the times.

The fields for entering times are on the same screen in section **SCHEDULE**. Readiness for recording is obtained after pressing *START* button. When analyzer waits for the start time the recording state icon on the top bar changes to . Proper data recording begins and ends at the set time interval. The scheduled recording process may be interrupted at any time manually by pressing *START*.

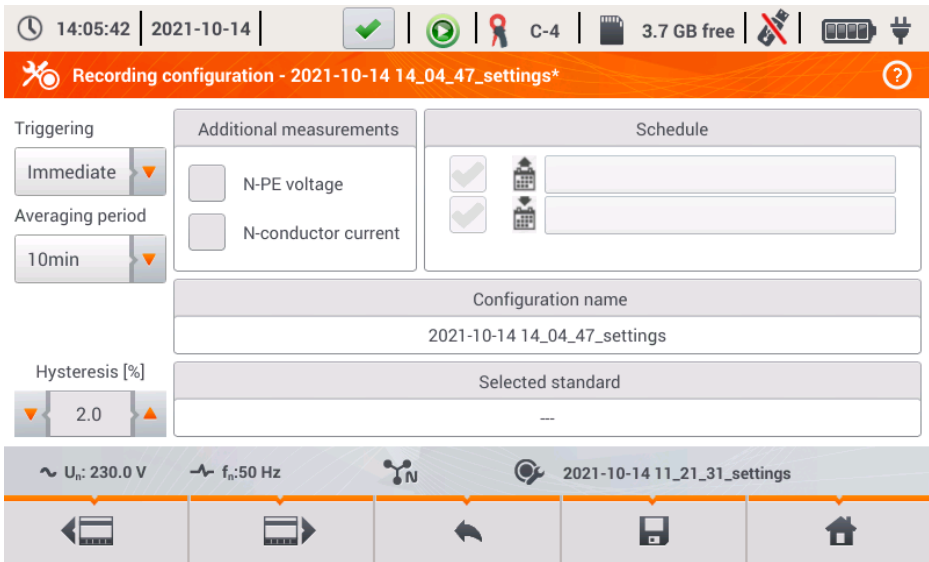

Fig. 7. Recording configuration – General settings II.

- **AVERAGING PERIOD** - specifies the averaging time of recorded parameters and also the time between successive recorded data on a memory card (except events). The following settings are available: 1 second, 3 seconds, 10 seconds, 30 seconds, 1 minute, 10 minutes, 15 minutes, 30 minutes.
- **HYSTERESIS** - percentage value in the range from 0.1 to 10, to be used for detecting events. Higher values allow to limit the number of detected events if the parameter value fluctuates around the threshold. The typical value of the hysteresis is 2%.

- **ADDITIONAL MEASUREMENTS** - in this section you can enable the measurement of additional channels:
  - **N-PE voltage** – ticking this box results in recording also parameters of voltage channel N-PE (as for other voltage channels).
  - **N-conductor current** – ticking this box results in recording the current in the neutral conductor. It is necessary to connect the probes in channel N.
- **CONFIGURATION NAME** – displays the current name of the edited configuration (read-only).
- **SELECTED STANDARD** - in case of recording acc. to a standard, this field displays the name of the selected standard, e.g. "EN50160 low voltage". In other cases, the field displays dashes "----".

### 2.9.3 Recording configuration – Voltage parameters

The screen for setting voltage parameters is shown in Fig. 8.

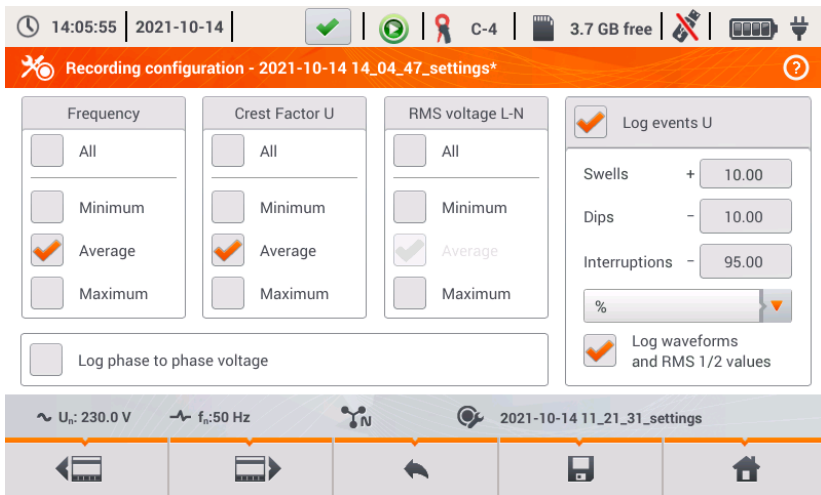

**Fig. 8. Recording configuration - Voltage parameters**

It contains the following elements:

- **FREQUENCY** - selection boxes for recording the following parameters:
  - Minimum - recording the smallest frequency value registered in averaging period. For example: in 10-minute averaging, this is the minimum value of 10-second frequency out of the 60 measured in that range.
  - Average - the averaged value of the frequency in the averaging period. For example: in case of this parameter and a 10-minute averaging, the value is the arithmetic mean of 60 frequency values measured in this period.
  - Maximum - the highest frequency recorded in the averaging period.
  - All - ticking this box will automatically select all three parameters (Minimum, Average, Maximum).
- **CREST FACTOR U** – selection boxes for recording voltage Crest Factor. Similarly to the frequency and most of the other parameters, the following fields are available:
  - Minimum
  - Average
  - Maximum

- **RMS VOLTAGE L-N** or **RMS VOLTAGE L-L** (depending on the type of network) - selection boxes for recording RMS voltage phase-to-neutral and phase-to-phase. Minimum and maximum values are searched from  $RMS_{1/2}$  values (RMS 1-cycle value refreshed every half-cycle). The user may select the following fields:
  - Minimum
  - MaximumThe average value is always recorded and ticked permanently.
- **LOG PHASE TO PHASE VOLTAGE** – ticking this box enables recording of the average phase-to-phase voltages in 3-phase 4-conductor systems or one phase-to-phase voltage in split-phase system (the box is active only in these two systems).
- **LOG EVENTS** – ticking this box enables voltage event detection: swells, dips, interruptions. Three field with values allow the user to introduce own thresholds for these three types of events. Thresholds may be entered in volts or as a percentage values referenced to the nominal voltage of the network, e.g. setting the threshold of swell as +10% at nominal voltage of 230 V triggers the detection of swell after exceeding 253 V voltage ( $RMS_{1/2}$ ). The event ends when the voltage drops to the threshold value reduced by hysteresis. If the hysteresis in the described case is 2%, then the end of the event will occur if when voltage ( $RMS_{1/2}$ ) is lower than 248.4 V (253 V - 4.6 V).
- **LOG WAVEFORMS AND RMS 1/2 VALUES** - ticking this box results in additional recording of waveforms of active measurement channels (also current channels) at the start and end of the voltage event. These waveforms have a standard length of 6 periods (approx. 120 ms), 2 periods of pretrigger (before start time) and 4 periods after.

### 2.9.4 Recording configuration – Current parameters

The view of this screen is shown in Fig. 9.

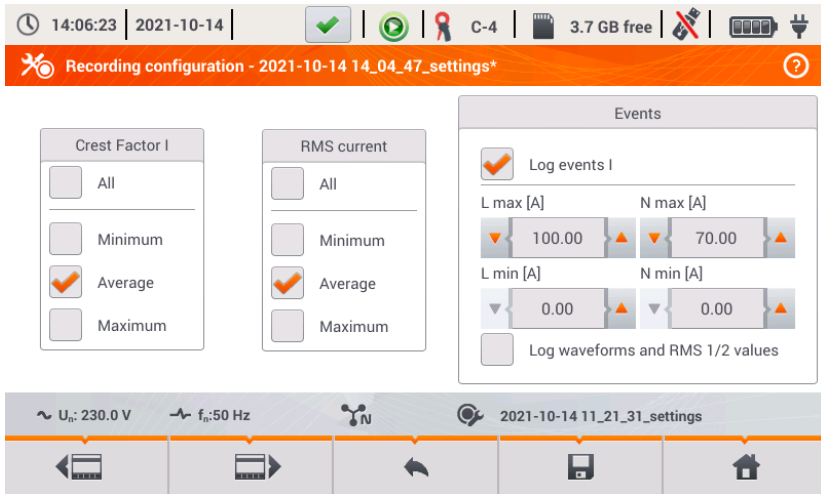

**Fig. 9. Recording configuration - Current parameters**

The elements are active (for editing) if the screen of general settings has enabled measurement of currents.

- **CREST FACTOR I** – recording current Crest Factor. You may record:
  - Minimum
  - Average
  - Maximum
- **RMS CURRENT** – recording RMS current, Available options:
  - Minimum
  - Average
  - Maximum

Minimum and maximum values in the averaging period are searched from all the  $RMS_{1/2}$  values, as in the case of the RMS voltage.

- **LOG EVENTS** – ticking this box enables current event detection. Entering "0" disables a given event. The entered values may be from range 0 ...  $I_n$  (where  $I_n$  is the current measurement range after taking into account current transformers)
  - **L max [A]** - maximum value threshold for current L1, L2, L3 (depending on the network). An event is detected when the value of  $RMS_{1/2}$  current exceeds the specified threshold.
  - **L min [A]** – minimum value threshold for current L1, L2, L3. An event is detected when the value of  $RMS_{1/2}$  current drops below the specified threshold.
  - **N max [A]** – similarly to L max, but it relates to N current channel (neutral current).
  - **N min [A]** – similarly to L min, but it relates to N current channel (neutral current).
- **LOG WAVEFORMS AND RMS 1/2 VALUES** - ticking this box results in additional recording of waveforms of active measurement channels (also voltage channels) at the start and end of the current event. These waveforms have a standard length of 6 periods (approx. 120 ms), 2 periods pretrigger time and 4 periods after start.

## 2.9.5 Recording configuration – Powers

Configuration screen Powers is shown in Fig. 10.

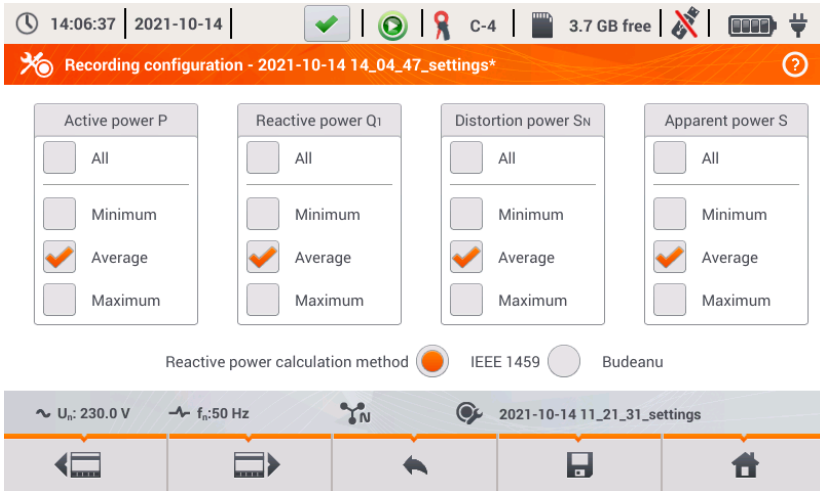

**Fig. 10. Recording configuration – Powers.**

It is possible to activate the recording of minimum, average and maximum values for the following power types:

- **ACTIVE POWER P**,
- **REACTIVE POWER Q<sub>1</sub>** (for IEEE 1459) or **REACTIVE POWER Q<sub>B</sub>** (for Budeanu method),
- **DISTORTION POWER S<sub>N</sub>** (for IEEE 1459) or **DISTORTION POWER D** (for Budeanu method),
- **APPARENT POWER S**.

In the lower part there is a checkbox "Reactive power calculation method": *IEEE 1459* (recommended and set by default) or *Budeanu*.

## 2.9.6 Recording configuration – Energy and power factors

Configuration screen **Energy and power factors** is shown in Fig. 11.

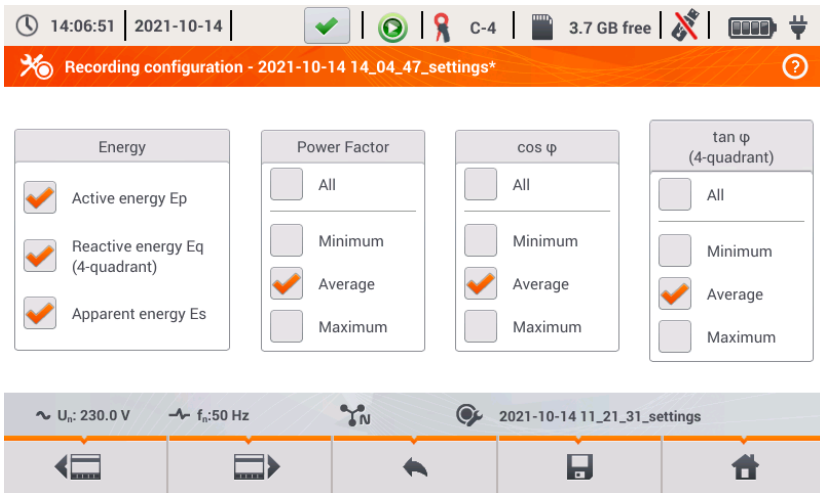

**Fig. 11. Recording configuration – Energy and power factors**

The following elements are available:

- **ENERGY:**
  - **Active energy  $E_p$**  - ticking this box activates recording of active energy. The readout of meters measuring active energy (consumed and supplied) will be saved at every averaging period.
  - **Reactive energy  $E_q$**  (4-quadrant) - ticking this box activates recording of reactive energy. The readout of meters measuring reactive energy (consumed and supplied) will be saved at every averaging period.
  - **Apparent energy  $E_s$**  - ticking this box activates recording of apparent energy. The readout of the energy meter will be saved at every averaging period.
- **POWER FACTOR** – user may enable recording of minimum, average and maximum,
- **$\cos \varphi$**  – recording of Displacement Power Factor (the phase shift between the primary voltage and current components). It is possible to activate the recording of minimum, average and maximum values.
- **$\tan \varphi$**  - recording tangent  $\varphi$  ratio (the ratio of reactive power to active power). It is possible to activate the recording of minimum, average and maximum values.

### 2.9.7 Recording configuration – Flicker and unbalance

Configuration screen **Flicker and unbalance** is shown in Fig. 12.

On this screen the user may enable the following parameters:

- **SHORT-TERM FLICKER SEVERITY P<sub>ST</sub>** – P<sub>ST</sub> factor is calculated every 10 minutes.
- **LONG-TERM FLICKER SEVERITY P<sub>LT</sub>** – P<sub>LT</sub> is calculated every 2 hours from 12 P<sub>ST</sub> values.
- **UNBALANCE AND SYMMETRICAL COMPONENTS U** - the user may enable recording of minimum, medium and maximum values. This group includes voltage parameters:
  - Positive sequence symmetrical component U<sub>1</sub> [V],
  - Negative sequence symmetrical component U<sub>2</sub> [V],
  - Zero symmetrical component U<sub>0</sub> [V],
  - Negative sequence unbalance factor u<sub>2</sub> [%], which is the ratio of negative sequence U<sub>2</sub> to positive sequence U<sub>1</sub> expressed as a percentage value,
  - Positive sequence unbalance factor u<sub>0</sub> [%], which is the ratio of positive sequence U<sub>0</sub> to positive sequence U<sub>1</sub> expressed as a percentage value,
- **UNBALANCE AND SYMMETRICAL COMPONENTS I** - the user may enable recording of minimum, medium and maximum values. This group includes current parameters:
  - Positive sequence symmetrical component I<sub>1</sub> [A],
  - Negative sequence symmetrical component I<sub>2</sub> [A],
  - Zero symmetrical component I<sub>0</sub> [A],
  - Negative sequence unbalance factor i<sub>2</sub> [%], which is the ratio of negative sequence I<sub>2</sub> to positive sequence I<sub>1</sub> expressed as a percentage value,
  - Positive sequence unbalance factor i<sub>0</sub> [%], which is the ratio of positive sequence I<sub>0</sub> to positive sequence I<sub>1</sub> expressed as a percentage value,

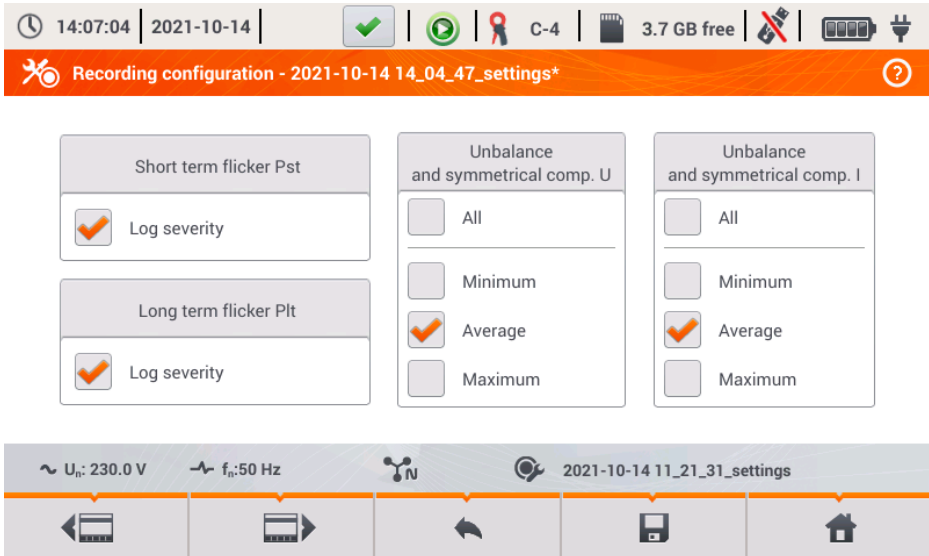

Fig. 12. Recording configuration – Flicker factor and asymmetry.

### 2.9.8 Recording configuration – THD, TDD and harmonics

The last screen of recording configuration is **THD, TDD and harmonics** (Fig. 13, Fig. 14). It allows user to activate recording of the following parameters:

- **THD U** – total harmonic distortion (THD) of voltage; factor THD-F is calculated (referred to the fundamental component). It includes 50 harmonics. You may record:
  - minimum,
  - average,
  - maximum.
- **HARMONICS AMPLITUDES U** – activating recording of amplitudes for 50 voltage harmonics. The following elements may be saved:
  - minimum values,
  - average values,
  - maximum values.
- **THD I** - Total Harmonic Distortion of current, similarly to THD for voltage,
- **HARMONICS AMPLITUDES I** – similarly to voltage harmonics,
- **TDD** – total demand distortion parameter.

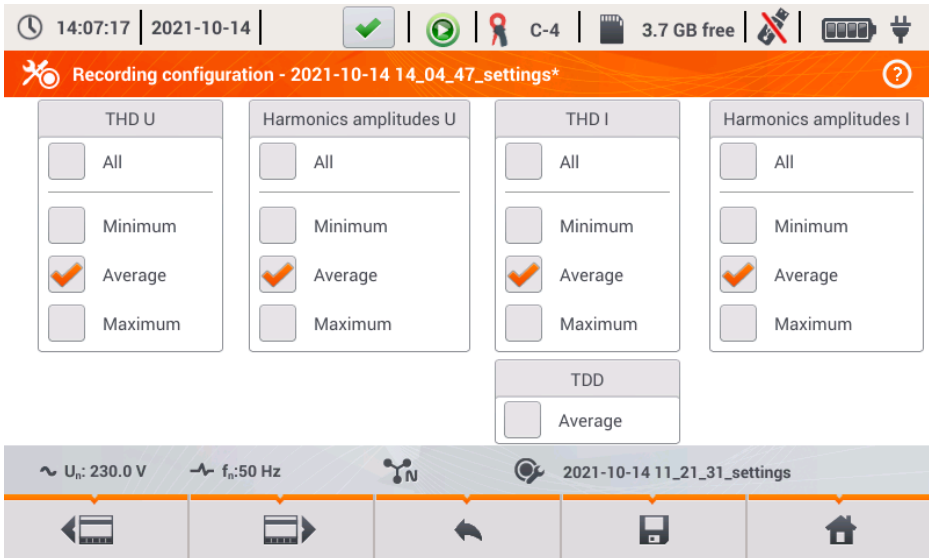



Fig. 13. Recording configuration – THD, TDD and harmonics.

After tapping the  or  icon the second part of the menu appears (Fig. 14). It allows user to activate recording of the following parameters:

- **HARMONICS ACTIVE POWER** - activates recording of all harmonic active powers,
- **HARMONICS REACTIVE POWER** - activates recording of all harmonic reactive powers.

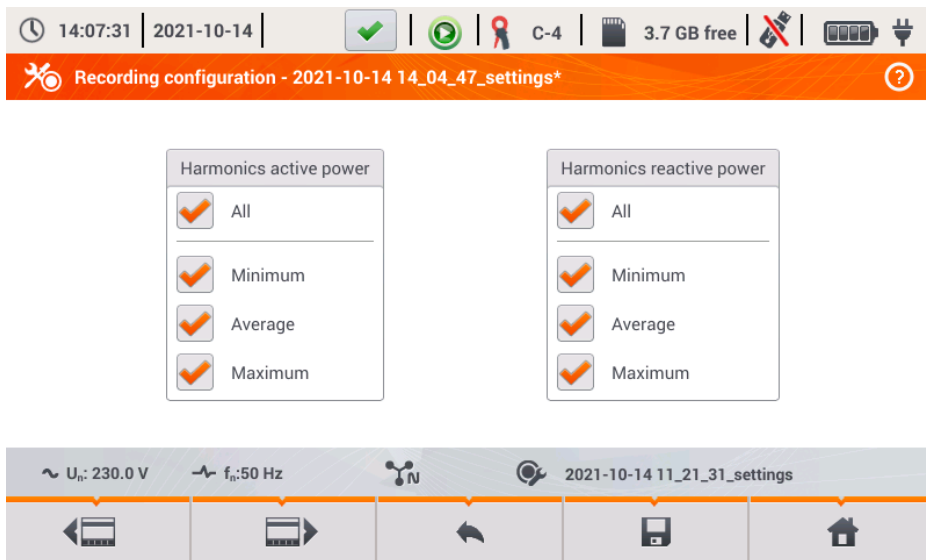

Fig. 14. Recording configuration – harmonic powers.

### 2.9.9 Configuration default settings



The default configuration settings ac. to the user are as follows:

- Mains type: 3-phase 4-wire,
- Nominal frequency: 230/400 V (phase/phase-to-phase) (120/208 V for US language settings),
- Nominal frequency: 50 Hz (60 Hz for US language settings),
- Current measurements and probes: activated current measurement with automatic probes,
- Voltage and current transducers: disabled,
- Triggering: immediate,
- Averaging time: 10 minutes,
- Event detection hysteresis: 2.0%,
- N-PE voltage and  $I_N$  current measurement: disabled,
- Recorded parameters: average values of the following parameters:
  - frequency,
  - crest factors for voltage and current,
  - RMS values of phase voltages and currents,
  - active power, reactive power, apparent power, distortion power (measurement method IEEE-1459),
  - active energy, reactive energy, apparent energy,
  - power factor PF,  $\cos\phi$  and  $\tan\phi$  factors,
  - flicker factors  $P_{ST}$  and  $P_{LT}$ ,
  - unbalance factors and symmetrical components of voltage and current,
  - THD U, THD I, harmonic amplitudes of voltages and currents.
- Event detection:
  - detection of voltage events activated: swell 110%  $U_{NOM}$ , dip 90%  $U_{NOM}$ , interruption 5%  $U_{NOM}$ , recording waveforms and  $RMS_{1/2}$  activated,
  - current events disabled.



The default configuration settings acc. to standard are as follows:

- Selected standard: EN50160 low voltage,
- Mains type: 3-phase 4-wire,
- Nominal frequency: 230/400 V (phase/phase-to-phase),
- Nominal frequency: 50 Hz,
- Current measurements and probes: activated current measurement with automatic probes,
- Voltage and current transducers: disabled,
- Triggering: immediate,
- Event detection hysteresis: 2.0%,
- N-PE voltage and  $I_N$  current measurement: disabled,
- Recorded parameters:
  - in accordance with standard requirements.
- Event detection:
  - voltage events in accordance with the requirements of the standard, enabled recording of waveforms and  $RMS_{1/2}$  values,
  - current events disabled.

### 2.9.10 Start / stop of recording

After correct configuring recording and activating it, measurements can be triggered. To do this, press the **START**  button. Recording in-progress is signalled by red icon  in the top bar and flashing red LED.



Before starting the recording, pay attention to the following issues:

- Verify time of the analyzer. If the date or time are incorrect, go to **ANALYZER SETTINGS** → **DATE AND TIME** to enter the correct data.
- Verify connections of the analyzer with the tested network. If the icon for the correct connection of the analyzer on the top bar is  or , then before recording parameters, an additional window is displayed warning about a potential problem with the connection. The user must confirm the start of recording ignoring the warning or cancel the start. For more information about the potential problem display the window informing about the correct connection (see sec. 2.18.1). It may be also helpful to check the phasor diagram (vectors of voltages and currents; rotation sequence of phases in 3-phase system should be such that phase UL1 (UL1-2) is at 0°, UL2 (UL2-3) approx. -120°, UL3 (UL3-1) approx. -240°. Both unbalance factors (for voltage and current) shown on this screen should be low (typically less than 10%, especially for voltage). The display of waveforms may be checked for the shape of the waveforms and the RMS values of voltages and currents. The correct connection of current probes may be verified by checking the mark(s) of active power - in most cases of operation of passive loads this sign will be positive.
- If the recording is longer, ensure the continuity of power supply by connecting an external 12V power supply adapter to the socket of the analyzer (the bar in the upper right corner will show an electric plug icon).
- If the user selected the probes of *Auto* type (automatic probes) in the measurement configuration, the analyzer after pressing **START** checks whether correct probes are connected. If an error is detected, an adequate message will be displayed; recording will not be triggered. The analyzer requires that all required channels use probes of the same type. The user sees the correct detection of probes on the top bar – when appropriate probes are detected, their type is next to the probes icon. If a question mark is displayed in this place, it means an error of connection. In DC systems, the only permitted probes are C-5 and C-5A.
- The memory card must be inserted into the socket, and have enough free space (which is indicated on the top bar). If the card has not enough free space for the expected records (which

depends e.g. on the averaging time, recording time, mains type and number of measured parameters), you must ensure a free space by deleting previous recordings (go to **ANALYZER SETTINGS → FILES**).

- Recording takes the name of measurement configuration, which is active at the time of its triggering and there is no possibility to change it later. Therefore, it may be helpful to name the configuration before that, using a name which describes the measurements to facilitate finding it on the list of records (the name of the configuration can be modified before the start, entering the edition of active configuration).

Stopping the recording process:

- To stop recording, press **START**  button and confirm your intention to stop in the pop-up window. Stopping the recording will be confirmed by sounds (one long and three short beeps) and the colour of the recording icon will change into green . Red LED will stop flashing. If the recording is secured by PIN code, you need to enter the correct code and unlock it first.
- Recording ends automatically as scheduled (if the end time is set), in other cases the user stops it by pressing **START**  or recording ends when the memory card is full.
- Recording ends automatically when the memory card is full.

### 2.9.11 Approximate recording times

The maximum recording time depends on many factors such as the size of the memory card, averaging time, the type of system, number of recorded parameters, waveforms recording, event detection, and event thresholds. A few selected configurations are presented in Tab. 3. The last column specifies the approximate recording times when the memory card is almost completely empty and has approx. 3.6 GB of free space. The typical configurations shown below assumes the measurement of the N-PE voltage and I<sub>N</sub> current. If the averaging time is different than the one chosen for the sample user configuration of 1 second, the approximate time of recording is proportionally extended, e.g. for 10-second averaging, the recording time will be 10 times the specified recording time at 1-second averaging.

**Tab. 3. Approximate recording times for a few typical configurations.**

Configuration type/ recorded parameters	Averaging period	System type (current measure- ment on)	Events (with waveforms)	Current measure- ment	Approximate re- cording time with 3.6GB allocated space
according to EN 50160	10 minutes	3-phase 4-wire	• (1000 events)	•	> 10 years
according to EN 50160	10 minutes	1-phase	• (1000 events)	•	> 10 years
User's recording, all parameters activated	1 second	3-phase 4-wire	• (1000 events)	•	17 days
User's recording, all parameters activated	1 second	3-phase 4-wire	• (1000 events)		39 days
User's recording, all parameters activated	1 second	1-phase	• (1000 events)	•	37 days
User's recording, all parameters activated	1 second	1-phase	• (1000 events)		77 days
User's recording, all parameters activated	1 second	3-phase 3-wire	• (1000 events)	•	25 days
User's recording, all parameters activated	1 second	3-phase 3-wire	• (1000 events)		51 days

## 2.10 Analyzer settings

After selecting **ANALYZER SETTINGS** section in the main screen, the screen shown in Fig. 15 will be displayed.

In this part of the meter interface, a series of screens is available for configuring many aspects of the analyzer operation. All settings are divided into the following three sections:

- **HARDWARE SETTINGS**
- **SETTINGS**
- **MANAGERS**

They are described in the following sections.

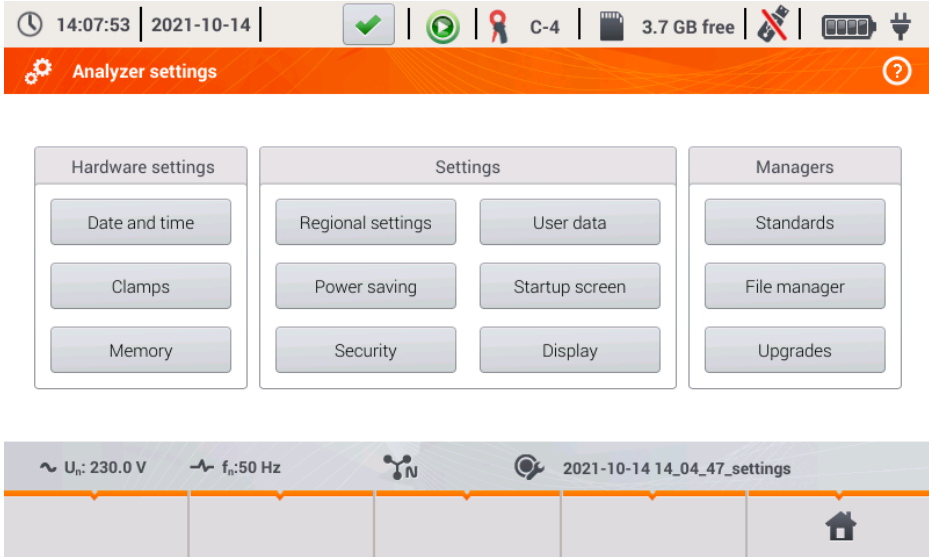

Fig. 15. Analyzer settings

### 2.10.1 Analyzer settings – Hardware settings

Section **HARDWARE SETTINGS** contains the following options:

- **DATE AND TIME** - to set the date and time of the analyzer. All measured data is determined in accordance with this time. You may also choose one of two ways to display the date:
  - **YYYY-MM-DD**
  - **MM/DD/YYYY**
- **PROBES** - This panel enables user to reverse phases of connected probes in the software. This is useful in situations where the physical reversing of probes is impossible or difficult. To reverse the phase of the selected channel, click on the appropriate icon. The default phase of the probes is marked as **DEFAULT**. Active reversing (by software) is marked as **REVERSED**. Phase of probes can not be changed during the recording process.
- **MEMORY** – displays information on the space on SD memory card, internal memory of the analyzer and possibly on a connected USB storage device (flash drive) (Fig. 16). Each of these three memories may be formatted by clicking **FORMAT** button. After acknowledging the warning message on deleting all data from the selected memory, the formatting process is started. All files stored on the specified memory will be permanently deleted.

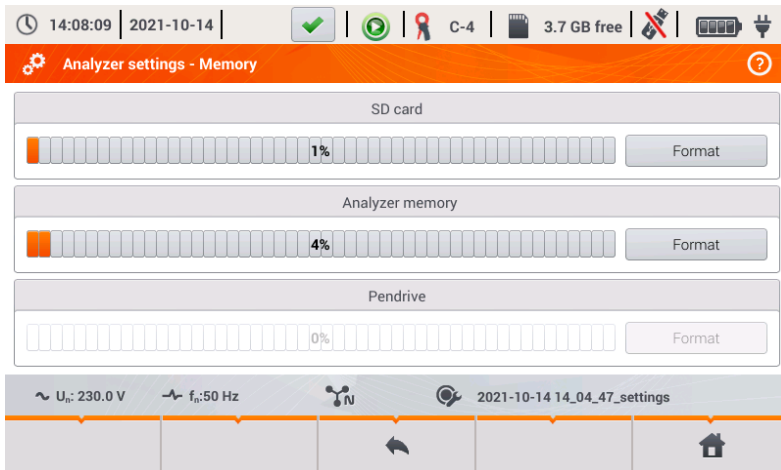

Fig. 16. Analyzer settings - Memory.

### 2.10.2 Analyzer settings – Settings

Section **SETTINGS** is divided as follows:

- **REGIONAL SETTINGS** – on this screen (Fig. 17) you may select:
  - Language,
  - Method for marking subsequent phases (L1, L2, L3, or A, B, C),
  - The colours assigned to each voltage and current channel in the interface. A few predefined colour profiles have been prepared (EU, Australia, India, China, USA), and two user profiles were marked as U1 and U2. After selecting one user profile from the list, a pop-up window will appear for setting the colour of each channel. First click on the channel to be set and then specify the desired colour.

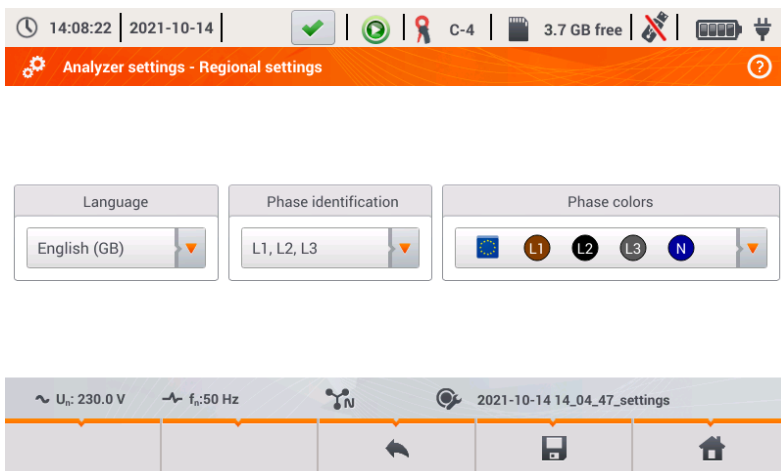



Fig. 17. Analyzer settings - Regional settings.

- **POWER SAVING** – the user can activate the Auto-off mode of the analyzer after a specified period of time (if no recording is on), and specify whether the meter is to be turned off completely or enter suspend mode.
  - **AUTO-OFF MODE**: selecting the method for auto-off: total inactivation (Switch off) or suspend.
  - **AUTO-OFF TIME** – the user may disable the auto-off by selecting **Never**, or specify the idle time after which the meter turns off (**After 10 minutes** or **After 30 minutes**).
- **SECURITY** – the analyzer may be protected against unauthorized access by 4-digit PIN code. Entering the code will be required every time after turning the meter on, when option **LOCK ANALYZER BY PIN CODE** is selected. The default PIN is "0000" and may be changed by clicking PIN field. Additionally, you can activate the blocking of the analyzer after 30 seconds from the start of recording. When you select this option, 30 seconds after recording is started (when user does not use the screen interface or buttons during the time), the analyzer displays a window to enter the PIN code. After entering wrong PIN three times in a row, the meter locks for 10 minutes. Only after this time, it will be possible to re-entry PIN.
- In order to reset the PIN code in emergency mode to its default value, hold for 5 seconds buttons  and  simultaneously. When the window with the PIN code is displayed, click on the box with blinking cursor. The keyboard screen will be displayed - enter "0000" code and confirm it.
- **USER DATA** - in this place you can enter your contact information. These data will be also printed in generated reports on compliance with the standard.
- **STARTUP SCREEN** - you can set the startup screen shown after starting the analyzer:
  - **WAVEFORM**
  - **TIMEPLOT**
  - **PHASOR**
  - **HARMONICS**
  - **MAIN MENU** (default)
- **DISPLAY** – in this place you can adjust the brightness of the LCD. The specified brightness affects the time of the analyzer operation powered from the battery pack. The automatic switching off the display ensures longer life of the battery pack; You can set the time for display switching off at 2 or 5 minutes from the last operation.

### 2.10.3 Analyzer settings – Managers



Section **MANAGERS** includes:

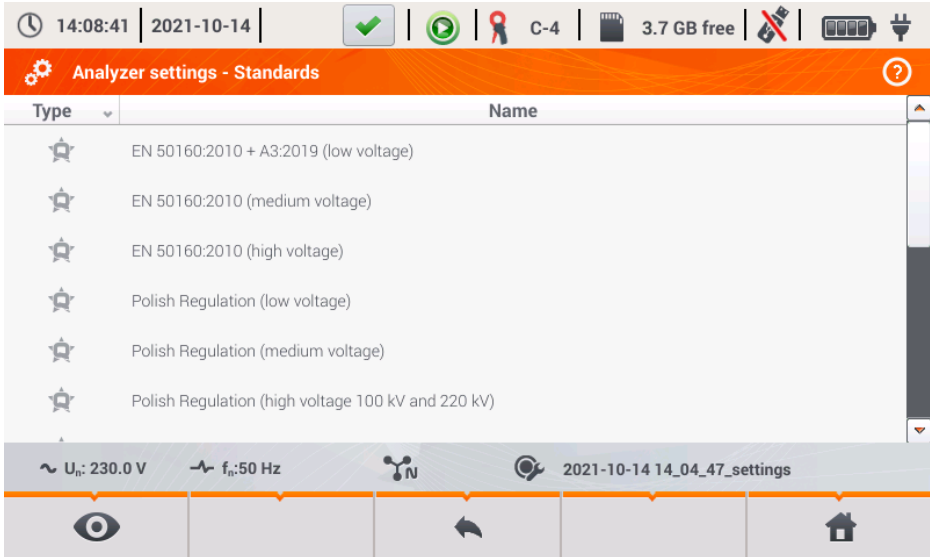

- **STANDARDS** – after selecting this option, a window is displayed, as shown in Fig. 18. This window shows a list of standards profiles stored in the internal memory of the analyzer that are used to generate the compliance reports.



**Fig. 18. Analyzer settings - Standards manager.**

After clicking the line of selected standard and then preview icon  in the bottom menu, the first configuration preview screen will be displayed for a given profile.

Buttons  and  at the bottom menu bar are used to switch between successive screens.

Button  allows you to switch the view to preview standard criteria that are used for generating standard compliance report. Similarly, buttons  and  allow user to switch between successive windows. Parameters of standards are stored permanently in the analyzer memory and can not be changed. They meet the current standards on power supply quality.

- **FILES** - This panel allows user to view and manage files saved in the storage media of the analyzer. After selecting it, a window appears with a list of files as shown in Fig. 19.

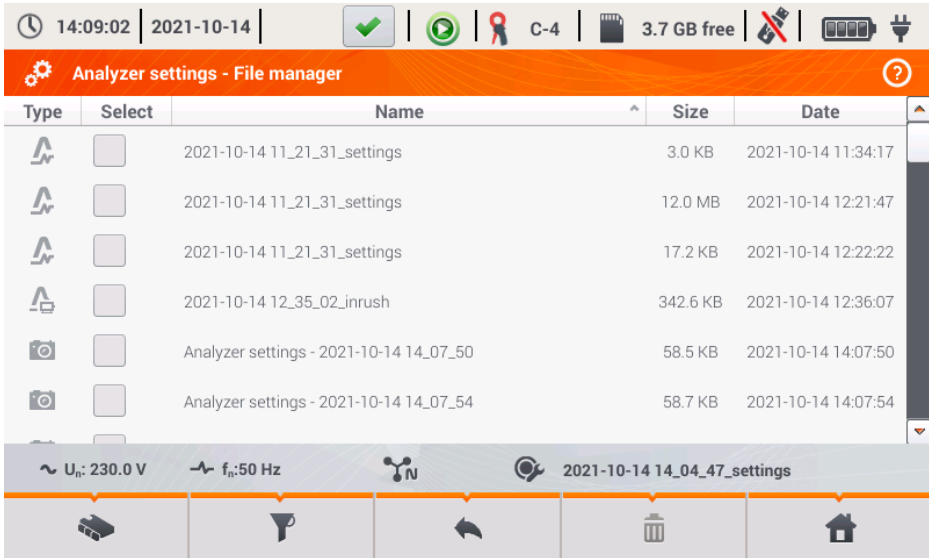

**Fig. 19. Analyzer settings - File manager.**

The following elements are specified in next table columns:

- **TYPE** – the icon representing the file type. It consists of the following types:
  - - recording file acc. to a standard
  - - recording file acc. to user configuration
  - - inrush recording file
  - - screenshot
  - - configuration file acc. to a standard
  - - configuration file acc. to user configuration
  - - configuration file for inrush
  - - configuration file for inverter efficiency test
  - - standard compliance report
- **SELECT** – in this column selection boxes are available for a given file (select them to copy or delete)
- **NAME** – name given to the file
- **SIZE** – file size
- **DATE** – date and time of last file modification

### Menu bar functions



- displaying an additional menu bar of file manager.



- switching the view to display the data stored in the microSD card.



- switching the view to display the data stored in the internal memory



- copying selected files to external media (USB stick); the icon is active only after connecting the storage medium.



- selecting all the files.



- displaying additional menu for filtering files. You may specify what types of files are to be displayed in the list by clicking the corresponding icons representing the file type; the selected file types are indicated by an icon in orange.



- delete selected files.

- **UPGRADES** – will be displayed as window shown in Fig. 20. In this mode, a memory stick can be connected to the analyzer with a file containing a new version of firmware. If such a file is detected and you confirm your intention to update firmware, the meter performs automatic upgrade process. The user should follow the on-screen prompts. The second option of updating is the use of *Sonel Analysis* software.



Please insert pendrive with update files or start update from Sonel Analysis.



Fig. 20. Analyzer settings - Update manager.

**Note!**

***Before starting the update, connect an external 12V DC power supply, to ensure continuity of supply. During an update, do not remove the USB memory.***

## 2.11 Recording analysis

PQM-707 allows user to perform a simplified analysis of the recorded data, using the device itself, without additional software. The scope of the analysis includes:

- general preview of the recording - start and end time, the number of recorded events, including their type, average values of voltages and currents,
- a detailed overview of all the events with a preview of waveforms and graphs of  $RMS_{1/2}$ ,
- preview the average value of voltage(s) across the whole recording range on a graph,
- preparing timeplots of any recorded parameters (limited to 1100 points and 4 parameters on a single graph) with zoom-in option and time-point marker.
- Bar-graph preview of harmonics (average value for the whole recording period).

It is possible to analyse recordings completed and saved on the memory card and on-going recordings.

### 2.11.1 List of recordings

To enter the analysis select **RECORDING ANALYSIS** in the main screen (the main screen is shown Fig. 2). After selecting this option, a list of recordings saved on the memory card is displayed as shown in Fig. 21.

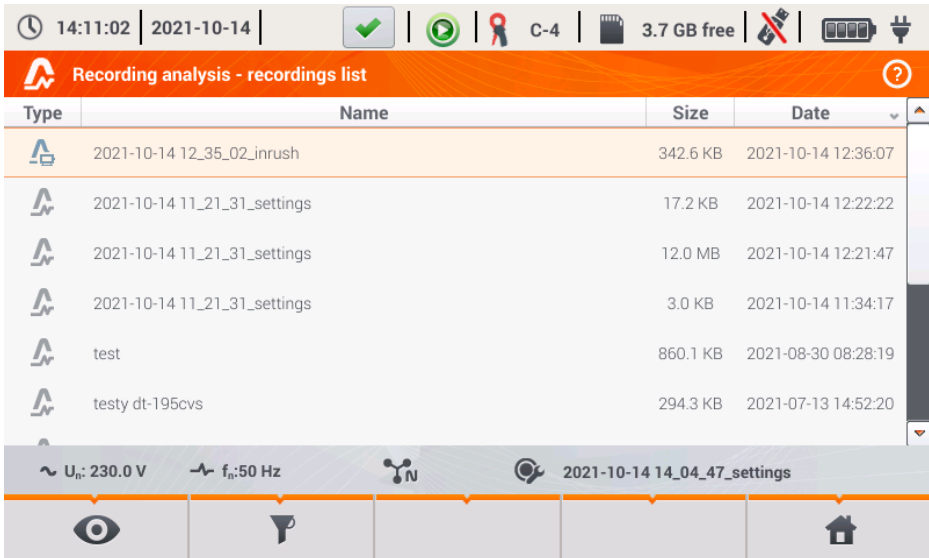







Fig. 21. Recording analysis - recording list.

The table columns present:

- **TYPE** of recording – the icon indicating recording type:
  -  - recording according to user configuration,
  -  - recording for compliance with the standard,
  - .
- **NAME** of the recording, which is the same as the name of the configuration, according to which the recording was made,
- **SIZE** of the recording,
- **DATE** of stopping the recording process.

In the case of an active recording, it is always on the top of the list, regardless of the selected sorting, and instead of icon for recording type, the recording icon is displayed .

**Menu bar functions**

-  - entering the analysis of the selected recording (also by double-clicking its name),
-  - displaying additional menu for filtering files. Specify which types of recording are displayed in the list. Orange icon means that this type was selected.

*The maximum number of recordings that can be saved in the recorder (memory card) is 99. After reaching this number, the possibility of making further registrations is blocked. Then you should free up some space in the memory card.*

**2.11.2 Recording summary window**

After selecting a record from the list of registration and clicking icon  (or double-clicking record name in the list), a recording summary window is displayed as shown in Fig. 22.

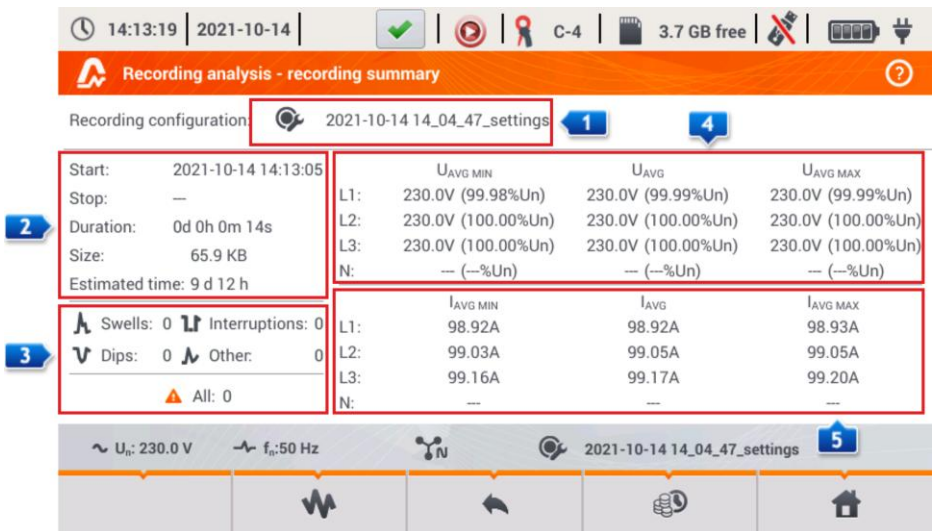

**Fig. 22. Recording analysis - Recording summary.**

The screen of the recording summary (Fig. 22) shows:

- recording configuration name **1**,
- start and end times of recording and its duration (if recording is still in progress - the end time is not shown), the free space on the memory card and the estimated time to fill the space by the recorded data **2**,
- the number of detected events, divided into several types **3**,
- average, minimum average and maximum average voltage values in the whole recording range **4**. Minimum and maximum values are determined from the recorded values of the average voltage (these are not minimum and maximum RMS<sub>1/2</sub> values). In addition to the values in volts, in brackets you can see the percentage value related to the nominal voltage. If a channel has not been measured in a given configuration, dashes are displayed.
- average, minimum average and maximum average current values in the whole recording range **5**. Similarly as for voltages, the minimum and maximum values are determined from average currents. If a channel has not been measured in a given configuration, dashes are displayed.

### Menu bar functions



- moving to the list of events.



- diagrams. Click to open an additional menu bar with the following options:



- timeplots. Description in sec. 2.11.3.



- a bar graph with the average values of harmonics. Description in sec. 2.11.8.



- generating a standard compliance report (only for recording acc. to standard). Description in sec. 2.11.6.



- moving to the energy cost calculator (only for recording acc. to user configuration). Description in sec. 2.11.10.

### 2.11.3 Timeplots – selecting the time range

Clicking icon  from the recording summary screen, takes you to a part of the interface, that allows you to generate timeplots of recorded parameters. The timeplot may include max. four different parameters.

The screen displays a window with the graph of average voltage RMS or DC (depending on the mains type) from the whole recording period.

This window (Fig. 23) contains the following elements:

- recording start time **1**,
- recording duration **2**,
- recording end time **3**,
- sliders of selected time range (left and right) **4**,
- chart of average voltage RMS/DC **5**,
- buttons for displaying sliders at left/right side of the window **6**,
- start time of the selected time range **7**,
- selected time period **8**,
- end time of the selected time range **9**.



The time range from which the user wants to plot the timeplots of parameters may be determined in two ways:

- using the sliders **4**. Grasp the corresponding slider and drag it, setting individual the beginning and end of the interval;
- writing the desired start and end time, or duration. In case of duration, the user must choose whether the time is to be related to the beginning or end of the range. Introduced range is checked for compliance with the requirements (limited to 1100 points) and if they are not met, the range is automatically modified to the allowable range (corresponding message is displayed).



Fig. 23. Recording analysis - selecting time range for the chart.

### Menu bar functions

-  - selecting parameters for timeplots,
-  - graph zoom menu.

### 2.11.4 Timeplots – selecting data

After selecting desired time range and clicking the icon for parameter selection  , a window will appear as shown in Fig. 24.

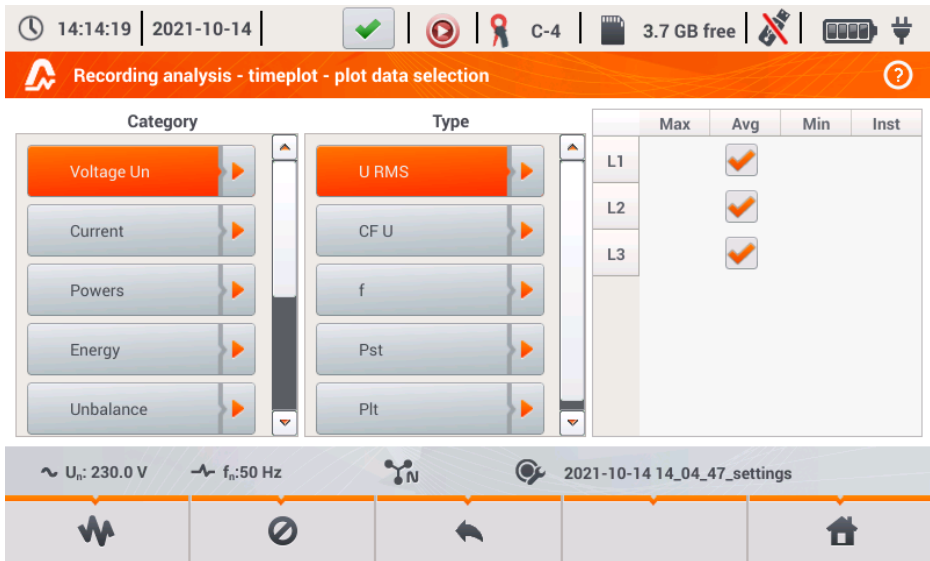

Fig. 24. Recording analysis - selecting parameters for the timeplot.

The specific parameter is selected in 3 steps:

- indicate **Category** of the parameter,
- it is followed by **Type** of the parameter within a particular **Category**,
- in the last step, select a particular parameter from the available channels and the minimum, average, maximum and instantaneous values.

**CATEGORY** and **TYPES** are grouped as follows:

- **VOLTAGE:**
  - **U RMS** (RMS voltage)
  - **U L-L** (phase-to-phase RMS voltage)
  - **CF U** (voltage Crest Factor)
  - **f** (frequency)
  - **PST** (short-term flicker severity)
  - **PLT** (long-term flicker severity)
- **CURRENT:**
  - **I RMS** (RMS current)
  - **CF I** (current Crest Factor)
- **POWER:**
  - **P** (active power)
  - **Q1/Qb** (reactive power)
  - **SN/D** (distortion power)

- **S** (apparent power)
- **cos $\phi$**  (Displacement Power Factor)
- **PF** (Power Factor)
- **tan $\phi$**
- **ENERGY:**
  - **EP+** (active energy consumed)
  - **EP-** (active energy supplied)
  - **EQ+** (reactive energy consumed)
  - **EQ-** (reactive energy supplied)
  - **ES** (apparent energy)
- **HARMONICS U:**
  - **THD U** (voltage Total Harmonic Distortion)
  - **UH1...UH50** (voltage harmonics of 1..50)
- **HARMONICS I:**
  - **THD I** (current Total Harmonic Distortion)
  - **TDD I** (current Total Demand Distortion)
  - **IH1...IH50** (current harmonics of 1..50)
- **HARMONICS ACTIVE POWER:**
  - **PH1...PH50** (current harmonics of 1...50)
- **HARMONICS REACTIVE POWER:**
  - **QH1...QH50** (current harmonics of 1...50)

After selecting the category and type, tick the box to choose a specific parameter in a particular measurement channel (or a total value).

In the window for selecting the parameters, only those parameters are displayed which were recorded.

For better orientation, the fields with parameters selected for the chart, the fields of category and type are surrounded by orange border, if they contain any selected parameters.

If you have already ticked four parameters, any attempt to select another will result in displaying a message on limited number of parameters in the chart.

### Menu bar functions



- display a timeplot of selected parameters.



- removes selection of all the selected parameters.

### 2.11.5 Timeplots of parameters – timeplot window







After clicking icon  in the selection screen data, a timeplot is generated showing changes in time of specified parameters (Fig. 25).



Fig. 25. Recording analysis - timeplot.

On the right side of the chart the following items are shown:

-  - start time of the whole plot,
-  - end time of the whole plot,
-  - time range of the timeplot (total),
-  - date and time marker
-  - buttons for individual waveforms with a value for the time marker.

The area of the chart may be freely enlarged (zoom-in) and moved using the touch panel. Zooming-in the graph does not affect the displayed times of start, end and duration – they are fixed and always apply to the whole plot - not only to the enlarged portion.

Each of the two scales describing the vertical axis may be assigned to one of the plotted parameters or to a few having the same unit.

#### Menu bar functions

 - displays additional menu bar for selecting displayed timeplots.

 - graph zoom menu.

 - displays additional menu for setting scales (Fig. 26). In this menu, you can select the description of the scale on the right and left side of the chart. To do this, click on the icon with the name of the parameter. The icon with the unit name is displayed when the graph have at least two parameters having the same unit. Click this icon to rescale plots having the same unit to a common scale (described by one of the common parameters). Remember that when scales are not unified, only one waveform with unit assigned to the axis is scaled to the indicated scale

and its plot is adjusted to the size of the window – other waveforms, even having the same unit, are not scaled.

 - screenshot of the current window to a graphic file.

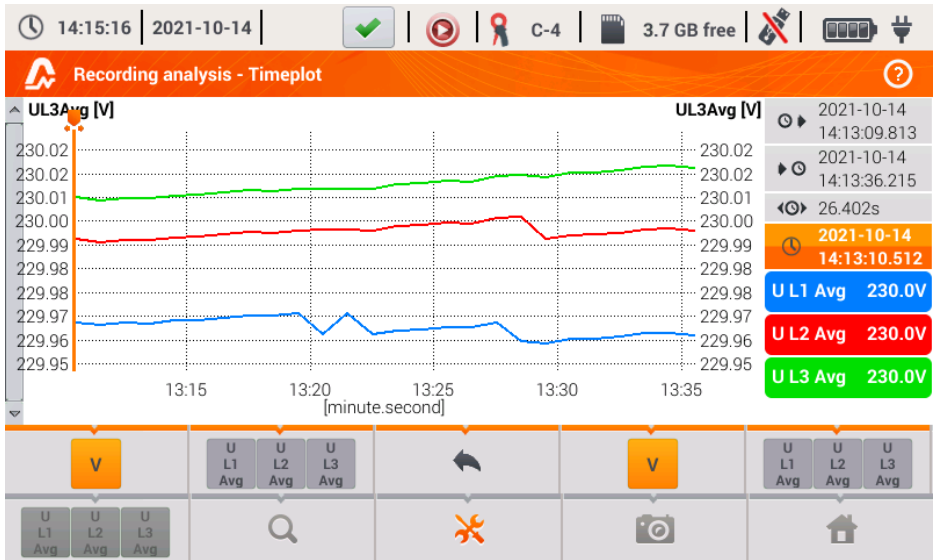



Fig. 26. Recording analysis - timeplot - selecting scale.

### 2.11.6 Generating report on compliance with standard

Selecting icon  on the recording summary screen, results in moving to the screen for generating report on compliance with the standard. If the recording was carried out according to the profile of one of the standards (e.g. EN 50160), then it is possible to verify whether the parameters of the tested network comply with standards requirements and generate a report, including a transcript of the report to a file.

To generate a report, you must first indicate a number of options that affect the way of generating the final report (Fig. 27).

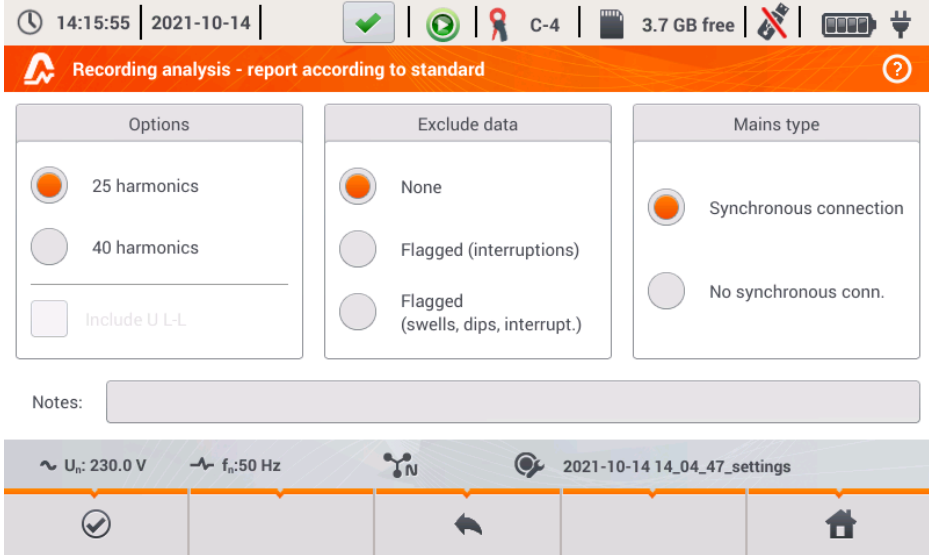





Fig. 27. Recording analysis - options of the report according to standard.





- **OPTIONS – 25 HARMONICS / 40 HARMONICS:** the user indicates the number of harmonics shown in the report. You can select 25 or 40 harmonics. The criterion to meet the requirements of the standard is in line with the standard guidelines and independent on number of harmonics indicated in this place. This setting affects only the number of harmonics shown in the summary table of the report.
- **OPTIONS – INCLUDE U L-L:** ticking this option results in including in the report statistics for the phase-to-phase voltages (if recorded). It applies only to split-phase and 3-phase 4-wire systems.
- **EXCLUDED DATA:** determines data to be excluded from the statistics in the report. There are three options available:
  - **NONE:** report includes all recorded data, including those during which the voltage events occurred,
  - **FLAGGED (INTERRUPTIONS):** statistics of the report are created using data from which the records including interruptions were removed. This is a typical setting, according to which reports should be generated according to the guidelines of EN 50160. Power failures are treated as exceptional situations in the network operation and as abnormal operation are not included in the quality statistics.  
The definition of an interruption in polyphase systems is consistent with

standard IEC 61000-4-30, i.e. a power supply interruption in such a system occurs when in all phases of the system an interruption was detected (at the same time).

In the report section describing the event, all interruptions are included.

- **FLAGGED (INTERRUPTIONS, DIPS, SWELLS)**: statistics of the report are created using data from which the records including interruptions, dips and swells were removed. In the report section describing the event, these interruptions are included.
- **CONNECTION – SYNCHRONOUS/NO SYNCHRONOUS**: Option **NO SYNCHRONOUS** is selected in island systems, isolated from other networks; otherwise, select option **SYNCHRONOUS**. The standards provide a separate quality criteria on frequencies for these two types of connections.
- **NOTES**: In this field you can type additional text, which will be included in "Note" section of the report.

After setting the parameters of the report, it may be generated by clicking icon  in the bottom bar. After a while, it will be displayed on the screen. The report may be scrolled using the finger-pointer or buttons  and .

Report may be saved to a file (in *pdf* format) on the memory card (from the bottom menu select icon , then from the additional menu bar select ) or after connecting USB memory stick to the analyzer (from the bottom menu select icon  and then from the additional menu bar select ).

A fragment of a typical report is shown in Fig. 28.

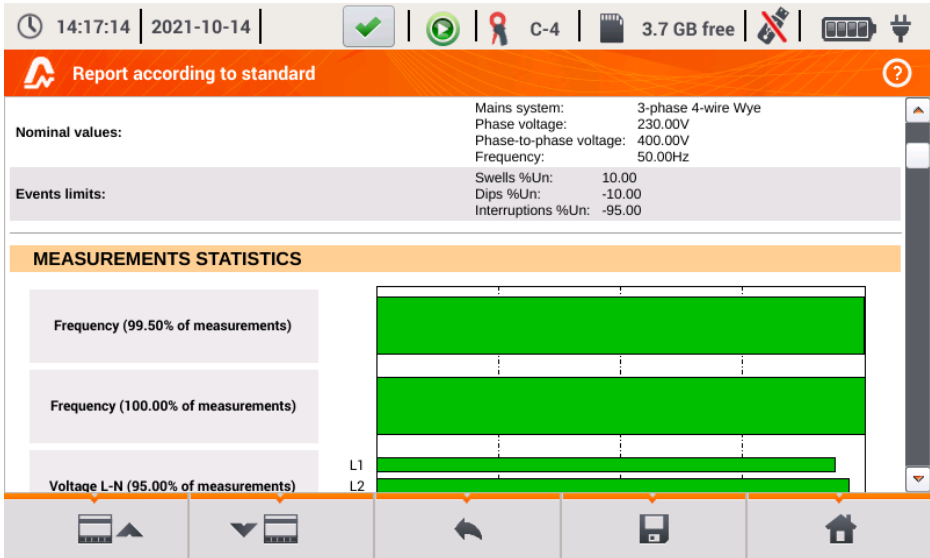

Fig. 28. Recording analysis - report according to standard.

### 2.11.7 Report according to standard - description

European standard EN 50160 specifies the characteristics and quality criteria that should be met by the distribution networks of low medium and high voltage. Many countries adopted provisions of this standard, sometimes slightly modifying it, entering own local rules for parameters of the power supply networks.

Standard EN 50160 divides distribution networks, depending on the nominal voltage into three groups:

- Low voltage networks (LV) with voltages  $U_{nom} \leq 1$  kV (in PQM-707 the profile for such networks is "EN 50160 (low voltage)"),
- Medium voltage networks (MV):  $1\text{kV} < U_{nom} \leq 36$  kV (profile "EN 50160 (medium voltage)"),
- High voltage networks (HV):  $36\text{kV} < U_{nom} \leq 150$  kV (profile "EN 50160 (high voltage)"),

Tab. 4 lists the quality parameters included in standard EN 50160 and the criteria for their evaluation for the low and medium voltage (parameters measured by PQM-707). It should be noted that these criteria relate to the normal operation of the network, excluding periods of power interruptions and other anomalies, e.g. those related to atmospheric phenomena.

#### 2.11.7.1 Section GENERAL INFORMATION

Section GENERAL INFORMATION contains general information about measurement parameters, including additional fields, which may be filled by the user when generating the report:

- Measurement performed by,
- Notes,
- Analyzer type and serial number,
- Software (analyzer software version)
- Time of start, end and duration of the measurement (acc. to local time of the analyzer)
- The number of averaged parameter samples, according to different times - this part specifies the number of time periods for which the parameters were measured:
  - 10 s - the number of frequency measurements,
  - 10 min - the number of measurement periods for most of other parameters such as RMS voltage, harmonics, THD, symmetrical components,
  - 15 min – used in reports on compliance with the *Polish Regulation*, where additionally 15-minute parameters are measured e.g. active power, reactive power and  $\tan\phi$ ,
  - 2 h – the number of time periods in which flicker factor  $P_{LT}$  was calculated.
- The number of excluded samples - the total number of excluded time periods due to activated option of excluding flagged data (due to interruptions alone or events such dip, swell, interruptions).
- Nominal values of the network:
  - Mains type,
  - Nominal phase and phase-to-phase voltage,
  - Nominal mains frequency.
- Event limits for swells, dips and interruptions.

**2.11.7.2 Section MEASUREMENT STATISTICS**

Section MEASUREMENT STATISTICS is a graphical summary of the tested network compliance with the standard. Verified parameter type is listed on the left side, while the right side shows the horizontal bars that define percentile of data that meets the quality criteria.

Percentile of a given percentage threshold is the value below which the percentage of all samples is present. Percentile 50% is also called the median; it determines the value for which half of the samples is below the median and the second half is greater or equal to it. In the area of power quality testing, the following percentiles are commonly used: 95%, 99% or 99.5%.

**Tab. 4. Power quality criteria according to EN 50160 for the low voltage networks (up to 1kV) and medium voltage networks (36 kV).**

Parameter	Basic parameter measurement time	Criterion																																																								
Slow changes in voltage - RMS voltage	10 minutes	For LV networks: for 95% of the measurements the deviation from the nominal voltage shall be within the range of $\pm 10\% U_{nom}$ for 100% of measurements: $-15\% \dots +10\% U_{nom}$  For MV networks: for 99% of the measurements the deviation from the nominal voltage shall be within the range of $\pm 10\% U_{nom}$ for 100% of measurements: $\pm 15\% U_{nom}$																																																								
Frequency	10 seconds	For networks connected synchronously: for 99.5% of the measurements the deviation should be within $\pm 1\% f_{nom}$ (i.e. for 50 Hz it is 49.5...50.5 Hz) for 100% of measurements: $-6\% \dots +4\% f_{nom}$ (47...52 Hz)  For networks connected asynchronously (e.g. island networks): for 95% of the measurements the deviation should be within $\pm 2\% f_{nom}$ (i.e. for 50Hz it is 49...51 Hz) for 100% of measurements: $\pm 15\% f_{nom}$ (42.5...57.5 Hz)																																																								
Rapid voltage changes (flicker)	2 hours	for 95% of the measurements the long-term flicker severity is $P_{LT} \leq 1$																																																								
Voltage unbalance	10 minutes	for 95% of the measurements of the negative-sequence unbalance factor should be $\leq 2\%$																																																								
Total Harmonic Distortion (THD-F)	10 minutes	for 95% of measurements, THD-F should be $\leq 8\%$																																																								
Voltage harmonics	10 minutes	For 95% of the measurements, the level of each voltage harmonic component related to the fundamental component should be less than: <table border="1" style="margin-left: auto; margin-right: auto;"> <thead> <tr> <th colspan="2">Odd order harmonics</th> <th colspan="2">Even order harmonics</th> </tr> <tr> <th>Order</th> <th>Relative level</th> <th>Order</th> <th>Relative level</th> </tr> </thead> <tbody> <tr> <td>3</td> <td>5.0%</td> <td>2</td> <td>2.0%</td> </tr> <tr> <td>5</td> <td>6.0%</td> <td>4</td> <td>1.0%</td> </tr> <tr> <td>7</td> <td>5.0%</td> <td>6 ... 24</td> <td>0.5%</td> </tr> <tr> <td>9</td> <td>1.5%</td> <td></td> <td></td> </tr> <tr> <td>11</td> <td>3.5%</td> <td></td> <td></td> </tr> <tr> <td>13</td> <td>3.0%</td> <td></td> <td></td> </tr> <tr> <td>15</td> <td>0.5%</td> <td></td> <td></td> </tr> <tr> <td>17</td> <td>2.0%</td> <td></td> <td></td> </tr> <tr> <td>19</td> <td>1.5%</td> <td></td> <td></td> </tr> <tr> <td>21</td> <td>0.5%</td> <td></td> <td></td> </tr> <tr> <td>23</td> <td>1.5%</td> <td></td> <td></td> </tr> <tr> <td>25</td> <td>1.5%</td> <td></td> <td></td> </tr> </tbody> </table>	Odd order harmonics		Even order harmonics		Order	Relative level	Order	Relative level	3	5.0%	2	2.0%	5	6.0%	4	1.0%	7	5.0%	6 ... 24	0.5%	9	1.5%			11	3.5%			13	3.0%			15	0.5%			17	2.0%			19	1.5%			21	0.5%			23	1.5%			25	1.5%		
Odd order harmonics		Even order harmonics																																																								
Order	Relative level	Order	Relative level																																																							
3	5.0%	2	2.0%																																																							
5	6.0%	4	1.0%																																																							
7	5.0%	6 ... 24	0.5%																																																							
9	1.5%																																																									
11	3.5%																																																									
13	3.0%																																																									
15	0.5%																																																									
17	2.0%																																																									
19	1.5%																																																									
21	0.5%																																																									
23	1.5%																																																									
25	1.5%																																																									

Percentile 0% is the same as the minimum value of the set of samples, whereas percentile 100% is equal to the maximum value of the set (there is no higher value).

For example, standard EN 50160 for the RMS voltage value specifies that 100% of measurements must be within the range of  $-15\% \dots +10\% U_{nom}$ , and 95% of measurements must be within the range of  $\pm 10\% U_{nom}$ .

These two requirements may be written as follows:

- percentile of 100% must be between  $-15\% \dots +10\% U_{nom}$ ,
- percentile 95% must be between  $-10\% \dots +10\% U_{nom}$ .

To check whether the RMS voltage meets the stated requirements, proceed as follows:

1. all measured voltage samples are sorted from the lowest [1] the highest [N]
2. it is checked whether the maximum value (i.e. percentile 100%, sample with [N] index) is in the range of  $-15\%$  to  $+10\% U_{nom}$ , and if yes then this criterion is met,
3. it is checked whether the value of the sorted table with index  $[N * 0.95]$  (first integer number greater than or equal to  $N * 0.95$ ) i.e. percentile 95%, is in the range of  $-10\% \dots +10\% U_{nom}$ . If yes, this criterion is met.

In case of the report on compliance with the standards and the section on measurement statistics, the length of the bands indicates the percentile of samples (the horizontal axis in the report ranges from 80% to 100%) that meet this criterion. For the RMS voltage, the statistics section provides two separate parameters, for which separate assessment criteria are set:

- Voltage (95.00% of measurements)
- Voltage (100.00% of measurements)

Bands on the right shows the percentage of samples that meet the specified criteria. For example, for 95% of the voltage measurements, if the band has the value 97%, it means that 97% percent of the samples meets this requirement (above the required 95%), and the band will be green (indicating that the criteria are met). If only 90% of the samples meet this criterion, the band will be red, as the standard criterion is not met.

If the percentage of samples that meet the criterion is less than 80%, then the band displays text in red "**< 80%**", which means that the criterion specified in the standard is not met and the percentile is lower than 80%.

The tested network meets the quality criteria if all percentile bands in section MEASUREMENT STATISTICS are green.

### 2.11.7.3 Section FREQUENCY

Section FREQUENCY includes detailed statistical information on the network frequency in the tested period.

The first part of the table, provides the percentage values of samples (percentiles), which meet the criteria (**Values within tolerance**) for both of the defined tolerance ranges (column **Tolerance**). The values that meet the criteria are displayed in black. When the criterion is not met, the value is displayed in red with an additional asterisk (\*). Column **Tolerance** specifies the range of frequencies, which must be observed in case of all samples, and which is calculated on the basis of the standard provisions.

The second part of this section contains additional information about the distribution of the samples in the tested set. Individual rows of the table present:

- **Maximum** (i.e. percentile of 100%) – the maximum recorded frequency,
- **99.50% value** - percentile 99.5% (99.5% of frequency samples is lower or equal to a specified voltage in volts); the percentile depends on the specified standard and may be different than the one shown here.
- **0.50% value** - percentile 0.5% (0.5% of voltage samples is lower or equal to a specified frequency); this percentile is always selected symmetrically to the previous percentile - to make the distance between two percentiles from the minimum or maximum was the same.
- **Minimum** (i.e. percentile of 0%) – the lowest frequency in the tested set of samples.

As in the first part, the frequency range is specified, where the values should fit to meet quality criteria; if a given value does not meet the criterion, it is displayed in red with an additional asterisk (\*).

#### 2.11.7.4 Section VOLTAGE

Section VOLTAGE includes detailed statistical information on the criteria for RMS voltage (phase voltage in systems with neutral conductor and phase-to-phase voltage in 3-phase 3-wire systems).

The first part of the table, provides the percentage values of samples (percentiles), which meet the criteria (**Values within tolerance**) for both of the defined tolerance ranges (column **Tolerance**). The values that meet the criteria are displayed in black. When the criterion is not met, the value is displayed in red with an additional asterisk (\*). Column **Tolerance** specifies the range of voltages, which must be observed in case of a specified percentage of samples.

The second part of this section contains additional information about the distribution of the samples in the tested set. Individual rows of the table present:

- **Maximum** (i.e. percentile of 100%) – the maximum voltage value among all samples in the given channel,
- **Value 95.00%** - percentile of 95% (95% of voltage samples have value lower or equal to a specified voltage in volts),
- **Value 5.00%** - percentile of 5% (5% of voltage samples have value lower or equal to a specified voltage),
- **Minimum** (i.e. percentile of 0%) – the lowest voltage value in the tested set of samples.

As in the first part, the voltage range is specified, where the values should fit to meet quality criteria; if a given value does not meet the criterion, it is displayed in red with an additional asterisk (\*).

#### 2.11.7.5 Section PHASE-TO-PHASE VOLTAGE

Section PHASE-TO-PHASE VOLTAGE is included in the report only when option **INCLUDE U<sub>L-L</sub>** is ticked during report generation and when network layout is split-phase or 3-phase 4-wire. Phase-to-phase voltage is also included in the statistics and influences the overall result of the network quality test. The value of phase-to-phase voltage is determined as:

- In split-phase systems: twice the phase voltage (second voltage (i.e. phase-to-phase) in the list of available nominal voltages in the measurement configuration or exact twice the phase voltage in the case of using voltage transducers)
- In 3-phase 4-wire systems: the second voltage (i.e. phase-to-phase) in the list of available nominal voltages in the measurement configuration or the phase voltage multiplied by  $\sqrt{3}$  in the case of using voltage transducers)

The percentage criteria for the phase-to-phase voltage are the same as for the phase voltage.

#### 2.11.7.6 Section FLICKER

This section provides information about the flicker severity  $P_{LT}$ . The first section provides the percentage of  $P_{LT}$  samples within the range required by the standard (e.g. 0...1).

The second specified the percentile value of 95%. Comparing this value with the limit imposed by the standard allows to assess the margin of  $P_{LT}$  parameter in the tested network in terms of standard provisions.

If a given value of  $P_{LT}$  is flagged after enabling the option for excluding flagged data, it is ignored and not reflected in the statistics.

#### 2.11.7.7 Section UNBALANCE

If the tested network is a three-phase network, the report in its UNBALANCE section specifies details of the negative sequence unbalance factor:

- the percentage of samples that meet the criterion of 95% percentile (or another specified in the standard),
- the actual value of the 95% percentile of the unbalance factor.

### 2.11.7.8 Section HIGHER ORDER HARMONICS

Section HIGHER ORDER HARMONICS includes statistics and measurements for individual harmonics for which the standard defines level limits (usually harmonics of 2..25) and Total Harmonic Distortion factor THD-F. If a value is not within the limits, it is displayed in red with an additional asterisk (\*).

### 2.11.7.9 Section HIGHER ORDER HARMONICS – ADDITIONAL INFORMATION

Section HIGHER ORDER HARMONICS - ADDITIONAL INFORMATION is present in the report after selecting report for 50 harmonics. It is an informational part, presenting values of percentile 95% for 26...50 harmonics, i.e. those for which the standard does not introduce level limits.

### 2.11.7.10 Section ADDITIONAL INFORMATION – EVENTS

Section ADDITIONAL INFORMATION - EVENTS contains information about detected voltage events such as swell, dip, interruption. For each of these types, the following information is provided:

- Number of events divided into single phases,
- Extreme value (maximum for swell, minimum for dip and interruption),
- Maximum duration of the event.

### 2.11.7.11 Section ADDITIONAL INFORMATION – STATISTICS OF POLYPHASE EVENTS

This section provides statistics of polyphase events according to the guidelines of EN 50160 (for swells, dips and interruptions). Events are classified basing on their duration and minimum / maximum values. The table presents the number of events meeting the specified couple of the criteria.

**Tab. 5. Statistical distribution of swells, according to EN 50160.**

Voltage crest U [%U <sub>nom</sub> ]	Duration time t [s]		
	0.01 ≤ t ≤ 0.5	0.5 < t ≤ 5	5 < t ≤ 60
U ≥ 120	S1	S2	S3
110 > U > 120	T1	T2	T3

**Tab. 6. Statistical distribution of dips, according to EN 50160.**

Residual voltage U [%U <sub>nom</sub> ]	Duration time t [s]				
	0.01 ≤ t ≤ 0.2	0.2 < t ≤ 0.5	0.5 < t ≤ 1	1 < t ≤ 5	5 < t ≤ 60
90 > U ≥ 80	A1	A2	A3	A4	A5
80 > U ≥ 70	B1	B2	B3	B4	B5
70 > U ≥ 40	C1	C2	C3	C4	C5
40 > U ≥ 5	D1	D2	D3	D4	D5
U < 5	X1	X2	X3	X4	X5

**Tab. 7. Statistical distribution of interruptions.**

Residual voltage U [%U <sub>nom</sub> ]	Duration time t	
	t ≤ 3min	t > 3min
U < 5	short interruptions	long interruptions

### 2.11.7.12 Section ADDITIONAL INFORMATION

Section ADDITIONAL INFORMATION is present in reports generated for compliance with the *Polish Regulation of the Minister of Economy*, when currents and 15-minute power values were measured. In such cases the following additional parameters are also recorded:

- 15-minute active power,
- 15-minute reactive power,
- 15-minute apparent power,
- total 15-minute  $\tan\phi$  factor

This section of the report presents the maximum 15-minute values recorded for the four parameters.

### 2.11.8 Harmonics graph

If the user selects option  in the recording summary screen, a bar graph will be generated with average harmonics for the whole recording period. Harmonics are averaged using RMS method. Structure of the chart and using the window elements is explained in sec. 2.16.5.



#### Note

***In case of large amounts of measurement data, plotting the harmonics chart may take a long time, which is indicated by a progress bar on the screen.  
Plotting a graph of harmonics with the same data will be immediate, thanks to the data buffering.***

### 2.11.9 Event list

Selecting option  from the recording summary screen (in the bottom menu) will display a window with a list of recorded events. The analyzer may detect the following types of events:

In 50/60Hz systems:

- voltage dips,
- voltage swells,
- voltage interruptions,
- exceeding the maximum current threshold ( $I > \max.$ ), separate thresholds for  $I_{1,2,3}$  and  $I_N$
- dropping below the minimum current threshold ( $I < \min.$ ), separate thresholds for  $I_{1,2,3}$  and  $I_N$

In DC systems:

- exceeding the absolute maximum DC voltage threshold ( $|U_{DC}| > \max.$ )
- exceeding the absolute maximum DC current threshold ( $|I_{DC}| > \max.$ )

If the user selected detection of any of the events listed above in the measurement configuration screen, and if these events have been recorded, the list will include all of them. An example of the event window is shown in Fig. 29.

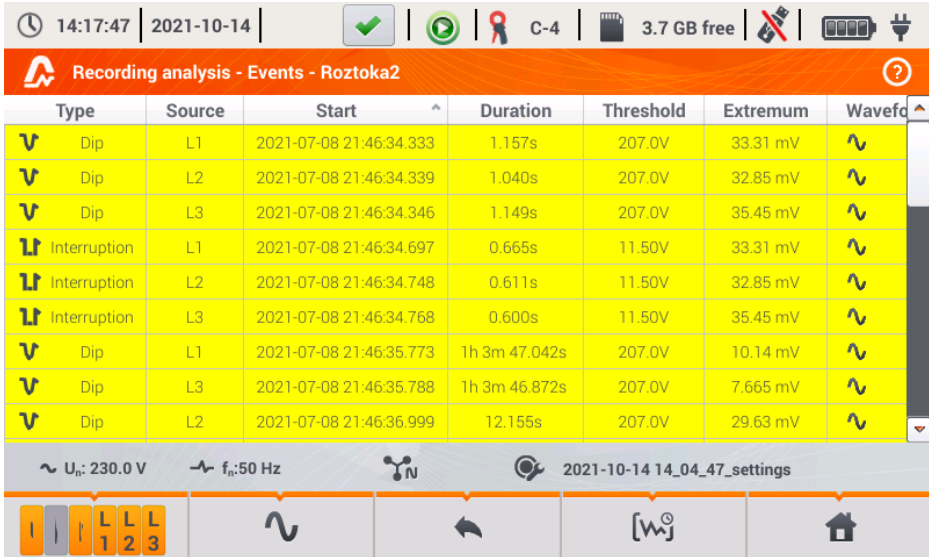

Fig. 29. Recording analysis – list of events.

The table contains the following columns:

- **TYPE** of event: dip, interruption, swell,  $I > \max$ ,  $I < \min$ ,  $U_{DC} > \max$ ,  $I_{DC} > \max$ .
- **SOURCE** of event: channel where the event occurred,
- **START**: date and time of beginning of event,
- **DURATION** of the event (if the event was in progress when recording was ended, an additional sign ">" is displayed, which means that the event has not been ended),
- **THRESHOLD**: threshold value that has been set in the recording configuration,
- **EXTREMUM**: parameter limit value (maximum or minimum, depending on the event type), which was recorded during the event. For example, in case of voltage dip, it is a residual voltage, which is the lowest  $U_{RMS1/2}$  value recorded during the dip.
- **WAV.** (waveform): when recording waveforms and  $RMS_{1/2}$  values is activated in the configuration, this column will show a sine wave icon indicating available waveforms and  $RMS_{1/2}$  values. These waveforms are recorded at the beginning and end of the event.

The table may be sorted by selected column after clicking its header. Next to the column name, a small arrow is present to show the direction of sorting.

### Menu bar functions

After selecting a specific event in the table (by clicking its line), you can perform additional operations by selecting the following options from the menu bar:

 - opens additional menu of waveforms:

 - waveform. After selecting a specific event in the table (by clicking its line) and indicating this option, a waveform of instantaneous voltage and current values (samples) is displayed for the beginning and end of the event. Usually (if activated in the configuration) 6 cycles are stored (120 ms for 50 Hz) for the beginning and 6 cycles for the end of the event (2 cycles before triggering and 4 after triggering). In case of missing data (e.g. when

the event was in progress at the end of recording process and data on event end are missing) only the available data are displayed, e.g. chart plotted only for the event start. An example of window for voltage dip waveform is shown in Fig. 30. The right panel shows the data of the event: start time, end time, duration and the values for the cursor. Similarly as for the other charts, the options are available for zooming in/out the chart area (also by double-click) and selection of displayed channels, etc.

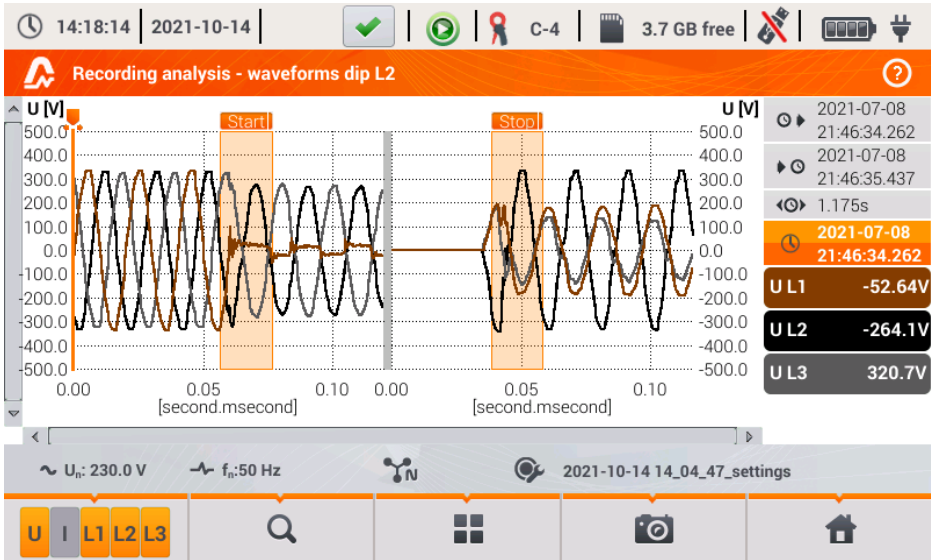



Fig. 30. Recording analysis - dip waveform.

 - RMS<sub>1/2</sub> plot. After selecting a specific event in the table (by clicking its line) and indicating this option, a waveform of RMS<sub>1/2</sub> is displayed. Usually, 15 mains cycles are saved (300 ms for 50 Hz) for the beginning and end of the event (5 cycles before triggering and 10 after triggering). In case of missing data (e.g. when the event was in progress at the end of recording process and data on event end are missing) only the available data are displayed. The functions in the chart window are the same as in case of waveform window.

 - ANSI chart. It shows the graph of voltage events according to ANSI criteria. Dots represent individual events and their location indicates the duration (horizontal axis) and peak (*extremum* in the event table) related to the nominal voltage on the vertical axis. Arrow icons on the right side of the graph may be used to select individual events. By touching the screen in the graph area, the user may move the marker to the indicated place. Information about the specified event (type, duration, extreme value) are shown on the right side of the screen. An example of screen with similar diagram is shown in Fig. 31.

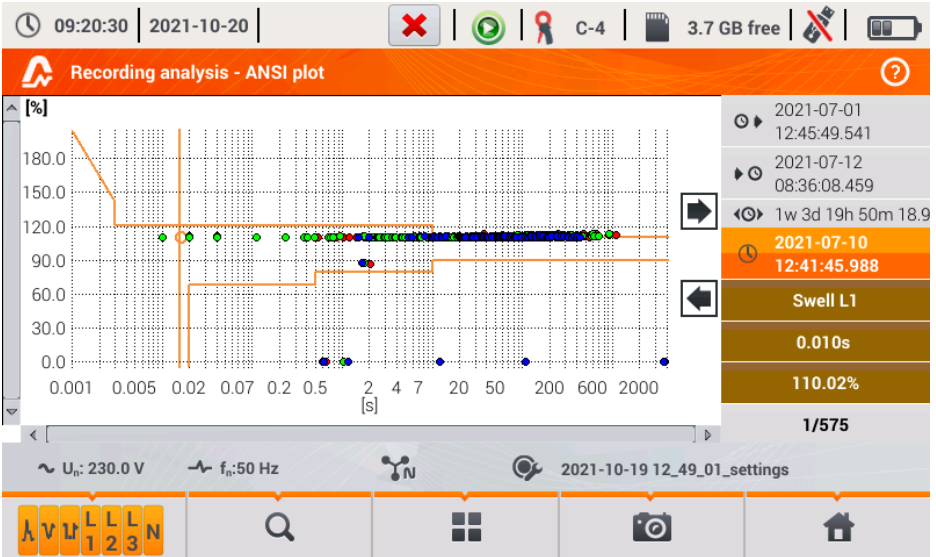

Fig. 31. Recording analysis – ANSI graph.



 - CBEMA graph. It shows the graph of voltage events according to CBEMA criteria. Description of the graph and its properties are similar to ANSI chart (see above). An example of screen with similar diagram is shown in Fig. 32.



Fig. 32. Recording analysis - CBEMA graph.

### 2.11.10 Energy cost calculator

When the parameters recorded by the analyzer include active energy  $E_P$  (see energy recording settings, sec. 2.9.6 and Fig. 11), it is possible to calculate the energy costs acc. to the cost calculator set by the user. To enter the screen of the energy cost calculator, use the bar on the recording

summary window (Fig. 22) and select icon . The screen with energy costs will be displayed as shown in Fig. 33.

The following sections present:

- **Recording time** – start, end and duration of the recording. The last line shows the duration taken for analysis by the algorithm of the cost calculator (full aggregation periods). The algorithm enables the calculation of the energy costs for the whole recording period and there is no option to select a different time interval.
- **Energy** – this field displays the total active energy in kilowatt-hours measured in the reporting time interval.
- **Single-zone tariff** – this section displays the total cost of energy in the selected currency for single-zone variant. The tariff of this type has a single flat rate per kWh, regardless of the time of day and day of the week. Name of the tariff (may be modified by the user) is displayed in the upper part.
- **Multi-zone tariff** – shows the total cost of energy in the chosen currency in the multi-zone variant. This tariff allows you to define two continuous time intervals in 24 hours, which have different cost rates per kWh, and the third rate for other times of the day. Configuration of rates and zones is carried out in the control panel of the energy cost calculator.

If you have not used or have not changed the settings of the cost calculator, the analyzer will use the default settings. The settings of the cost calculator may be modified by selecting from the menu bar option .

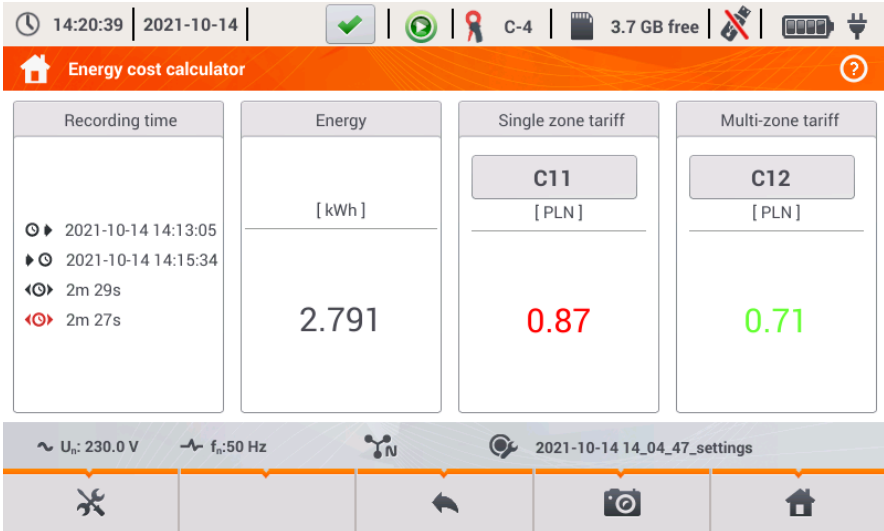



Fig. 33. Screen with summary of the energy cost calculator.

#### Menu bar functions

 - entering the settings of the energy cost calculator.

### 2.11.10.1 Settings of the energy cost calculator

The settings of the cost calculator may be easily modified to fit individual needs. The energy cost calculator in the analyzer allows you to calculate costs for two tariffs:

- Single-zone tariff – this is the simplest form of tariffs - a single rate for each kilowatt is taken into account throughout the analysed interval, regardless of time of day or day of the week.
- Multi-zone tariff – a more extensive tariff, which allows you to set three different rates that apply in different time intervals:
  - Zone A billing rate – you may enter the cost of 1 kWh for the first time interval of the day (e.g. daytime rate),
  - Zone B billing rate – you may enter the cost of 1 kWh for the second time interval of the day (e.g. night-time rate),
  - Zone C billing rate (not included in zones A and B).

Settings of the cost calculator are divided into two screens shown in Fig. 34 and Fig. 35.

The first screen allows you to configure the following parameters:

- Currency - you can choose from a list of several predefined currencies (PLN, EUR, USD, RUB, INR) or set your own (up to four characters), which will be shown on the list as the last position and marked with an asterisk (\*).
- For single-zone tariff:
  - Name of the single-zone tariff (C11 as default) - after clicking the name field a panel is displayed for editing.
  - Billing rate – the cost of 1 kWh of energy for single-zone tariff - after clicking on the value field a panel is displayed for editing. Rate values may be entered with an accuracy of four decimal places.

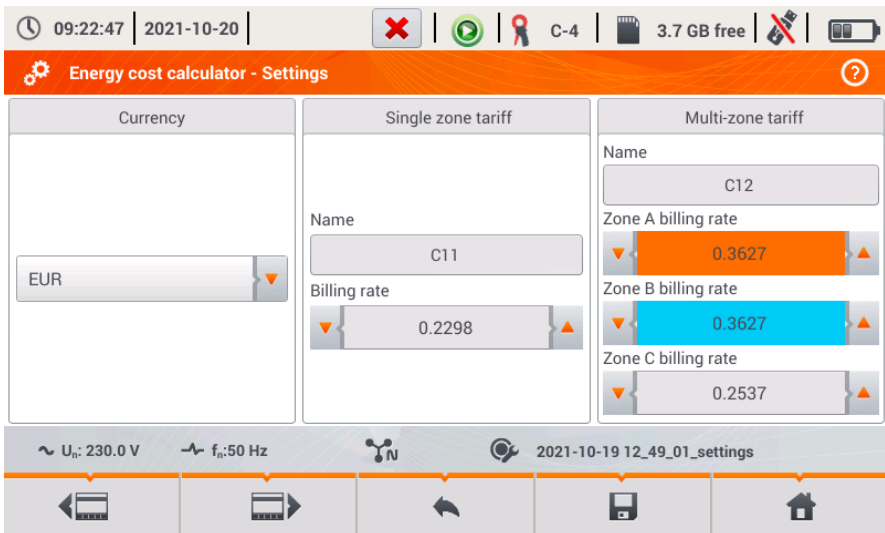
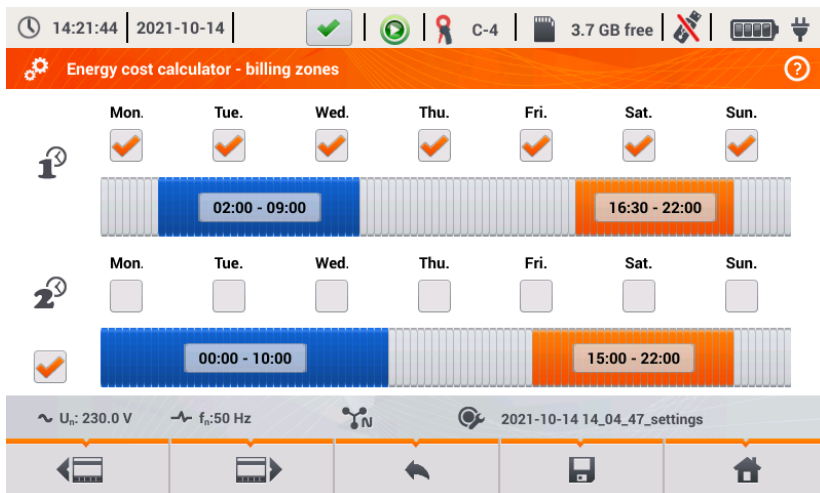

Fig. 34. Energy cost calculator – Settings.

- For Multi-zone tariff:
  - Name of the zone (C12 as default)
  - Zone A billing rate for 1 kWh,
  - Zone B billing rate for 1 kWh,
  - Zone C billing rate for 1 kWh (for other times of the day).

Time intervals of the day corresponding to A, B and C zones are set on the second screen with settings (Fig. 35). Colours of time intervals on the second screen match the colours of billing rates on the first screen. In the simpler variant, the same zone settings are valid for all days of the week (only the set marked with icon **1**). If you need to configure other time intervals for the selected days (e.g. for Saturdays and Sundays), then click the selection box at the bottom left of the window - the second set of time intervals is unlocked - it is marked with icon **2**. Select weekdays for the second set by clicking the selection boxes for desired week days.

Both bars displayed on the screen represent the entire day [24 hours] divided into 15-minute blocks.



**Fig. 35. Energy cost calculator – billing zones**



Time intervals for zones A and B may be modified:

- by touching the centre of the time interval and moving it sideways,
- by touching the left or right edge of the interval and changing the start or end of the tariff zone.

Start and end time is displayed in the middle of the time interval. The resolution of time intervals is 15 minutes. The minimum duration of an interval is 2 hours.

To save the changes in the analyzer memory, select option  from the menu bar and confirm your intention to save changes. The settings are global for the entire analyzer (not related to a specific recording).

### Menu bar functions

  - switching between the two setting screens of the cost calculator.

 - saving the settings in the analyzer memory.

 - return to the results indicated by the cost calculator. If the settings have been modified and saved, the energy costs will be automatically calculated and displayed.

### 2.11.11 Generating report on compliance with standard NEC220.87

Selecting icon  on the recording summary screen, results in moving to the screen for generating report on compliance with the standard NEC220.87. This screen is shown in Fig 37.

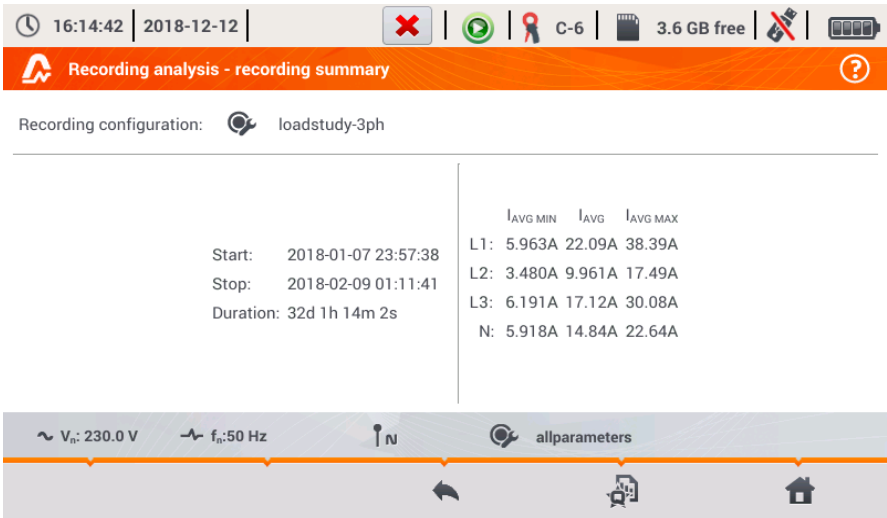



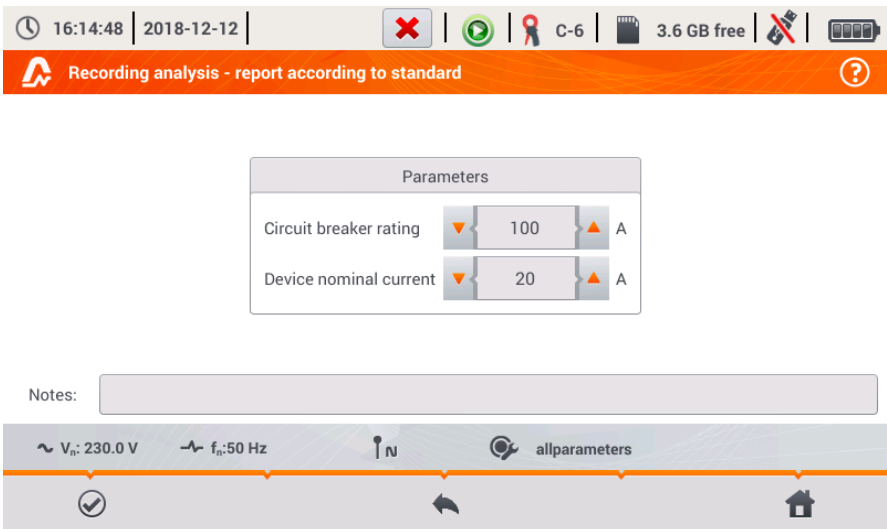

**Fig. 36. Recording analysis – recording summary according to standard NEC220.87.**





To generate a report, you must first indicate two parameters required by the standard NEC220.87. This screen is shown in Fig 37.

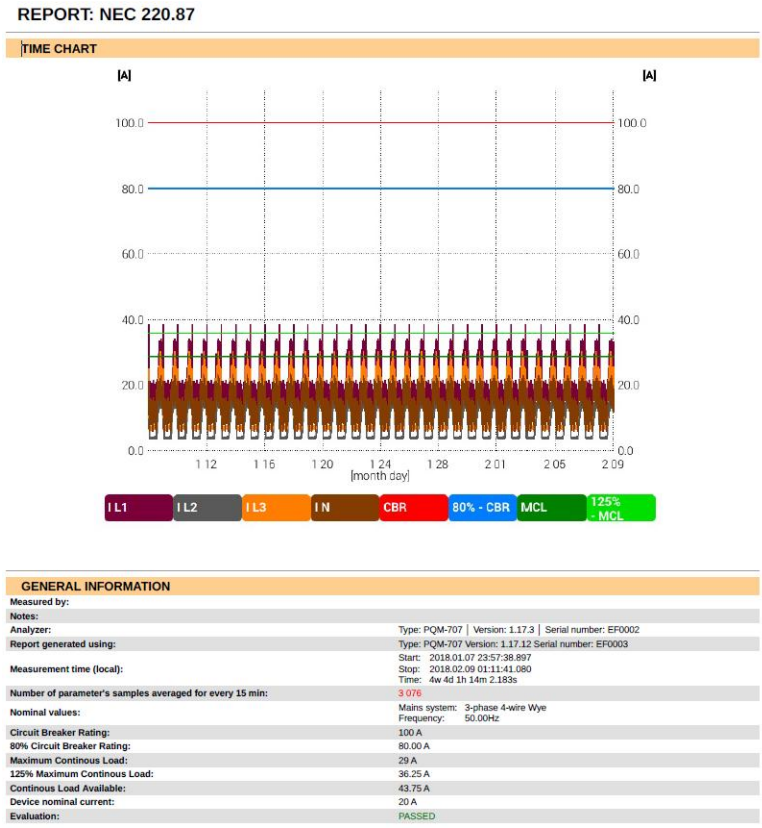

**Fig. 37. Recording analysis – parameters of the report according to standard NEC220.87**

- **CIRCUIT BREAKER RATING IN AMPS:** nominal breaker current of circuit breaker for existing installation under test. Could be nominal breaker current of circuit breaker which will be used for this installation..
- **DEVICE NOMINAL CURRENT:** nominal current of new device in installation

After setting the parameters of the report, it may be generated by clicking icon  in the bottom bar. After a while, it will be displayed on the screen. The report may be scrolled using the finger-pointer or buttons   and  .

Report may be saved to a file (in *pdf* format) on the memory card (from the bottom menu select icon , then from the additional menu bar select ) or after connecting USB memory stick to the analyzer (from the bottom menu select icon  and then from the additional menu bar select  ).An example of a typical report is shown in Fig. 28.



**Fig. 38. An example of a typical report.**

If the duration of the registration is displayed in red, it means that the registration lasted less than 30 days

## 2.12 Inrush current

The mode of measuring the inrush current is entered by selecting in the main screen the option of **INRUSH CURRENT**. This mode is used to measure the inrush currents of various machines, equipment and facilities with sharp increases in current consumption. During a start-up such machines/equipment usually draw instantaneous currents significantly higher than nominal currents, which is caused for example by charging capacitors, mechanical resistance and magnetization of the core (motors and transformers). Knowing the value of inrush currents enables the user to correctly choose the over-current protection parameters for power supply systems supporting such devices (characteristics and nominal current values) in order to protect the system and its users in the event of a failure, but at the same time to prevent accidental tripping of the breaker during the start-up of the devices.

PQM-707 analyzer allows user to quickly and easily measure inrush currents, providing the information about:

- timeplots of instantaneous currents (waveforms),
- timeplots of half-period RMS values -  $RMS_{1/2}$ ,
- the maximum recorded values of half-period RMS values and Joule integral values  $i^2t$ .

Joule integral is a measure of the heat generated during the start-up. To determine  $i^2t$  - a time interval is taken from the moment of exceeding by  $RMS_{1/2}$  current the threshold value until lowering the value of  $RMS_{1/2}$  current drops below the threshold minus the hysteresis (by default hysteresis is equal to 2% of the nominal value -  $I_{NOM}$ ). Knowing the Joule integral is useful when choosing the overcurrent protection of circuits - manufacturers of protection devices usually state in specifications the characteristic value  $i^2t$ , which triggers the device and interrupts the current flow in the circuit. Joule integral of the protection devices must be higher than the value measured during the measurement of inrush energy (integral).

Recording time of the waveform may be set in the range of from 5 to 60 seconds. Recording is triggered automatically after exceeding the set current threshold and ends after the set time. Moreover, waveforms before triggering (pretrigger) are recorded (1 second), providing the user with information about the currents before the triggering.

Only current waveforms are recorded; voltage is not recorded, it is also not necessary to connect voltage inputs of the analyzer.

The measuring algorithm implemented in PQM-707 ensures correct measurement of half-period RMS values also in a situation of variable frequency of the power supply current. This is useful in for devices powered from inverters (frequency converters). The permissible range of frequency variations is 30 ... 100 Hz. The algorithm is based on digital filtering of I1 current waveform, which removes all components of frequencies higher than the fundamental, allowing precise determining of points where current waveforms cross zero value, resulting in correct determination of RMS values during variable frequencies.

### 2.12.1 Inrush current measurement configuration

After selecting in main menu the option of **INRUSH CURRENT** the screen shown in Fig. 39 is displayed.

Before measuring the inrush current, the user must indicate the measurement parameters:

- **MAINS SYSTEM** – selection of the type of mains supplying power to the tested device, specifying current channels for connecting the probes: 3-phase 4-wire, 3-phase 3-wire, 3-phase 3-wire with Aron's method measurement of currents, split-phase, single-phase, 3-phase 4-wire (no U L2) / 2 ½ element (no V L2/B), 3-phase open delta.
- **FREQUENCY** – nominal frequency of power supply to the device (this frequency is used in the absence of current signal; the default algorithm is insensitive to the measured waveform frequency),
- **PROBES TYPE** – indicate the type of current probes used,

- **RECORDING TIME** – duration of recording from the triggering (exceeding the current threshold) may be selected from the following times: 5s, 10s, 15s, 20s, 25s, 30s, 60s.



Fig. 39. Inrush current configuration screen.





- **NOMINAL CURRENT [A]** – enter the nominal value of  $I_{NOM}$  (one phase) of the tested device.
- **TRIGGER THRESHOLD [A]** – this field is automatically set to 150% of the nominal current during the first edition of **NOMINAL CURRENT [A]** field (subsequent editions no longer update this field), but the user may enter a different value if necessary. This is the current threshold value – when this value is exceeded the countdown of recording time is triggered. This value is also used for determining the thermal integral  $i^2t$  – this integral is calculated for the time interval when the measured current value is above the triggering threshold. The threshold value is displayed on graphs as a horizontal line and the field with its value is shown on the right side in the current axis area.
- **VOLTAGE CHECKBOX** – selection of this checkbox enables recording of the voltage.

The title bar displays the default name of the edited configuration, which is created basing on current date and time, e.g. "2017-01-01 12\_10\_00\_inrush". This name may be modified when you save the configuration.



#### Menu bar functions

- start of the measurement session for inrush current with specified settings (without saving the configuration).

- saving the configuration of inrush current to a file with an option to start the measurement directly after saving (field [Go to measurement](#) in the pop-up window).



 - entering the list of saved configurations of inrush current and creating a new configuration. Configurations of the inrush current are presented similarly as the measuring configurations (see Fig. 4), they have their own icon . Double-click on a selected configuration will open it automatically and the inrush current configuration screen (Fig. 39). The button in the menu bar -  is used for adding new configurations starting of the inrush current (a window is displayed, as shown in Fig. 39 with default settings). Icon  is used to edit the chosen configuration of the inrush current.

### 2.12.2 Inrush current measurement and analysis

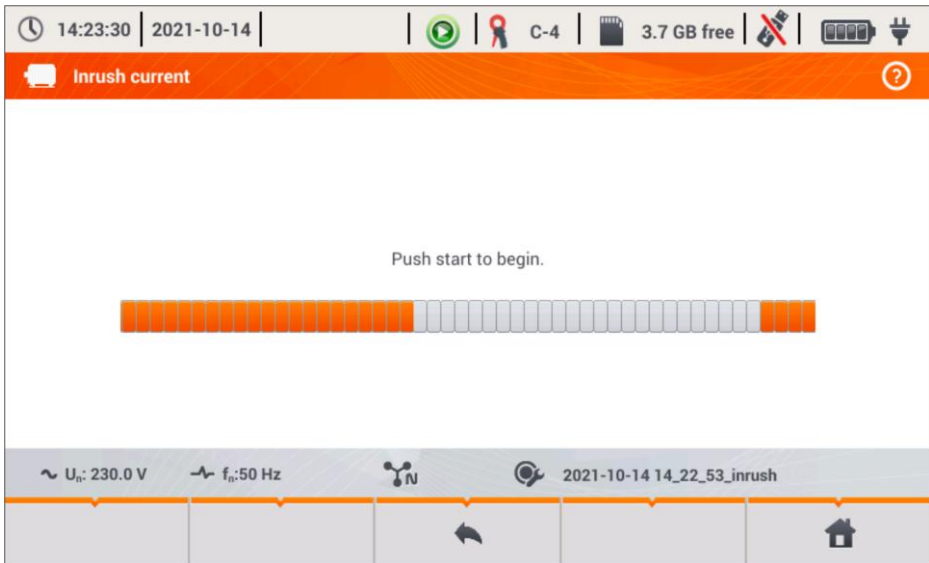
In the screen of inrush current settings, select the following icon  in the menu bar to display a window shown in Fig. 40. Press **START**  to start measurement.



**Fig. 40. Inrush current - waiting for start of the measurement.**

The analyzer enters the mode of monitoring currents and triggers the measurement if the current value in any of the measured channels exceeds the threshold value. The recording status icon changes to . At this moment you should switch on the tested device. The user may interrupt the process of waiting for a trigger by pressing **START**  button. Exceeding the threshold and correct triggering will be signalled by an audible recording signal (triple tone) and the countdown of recording time will start.

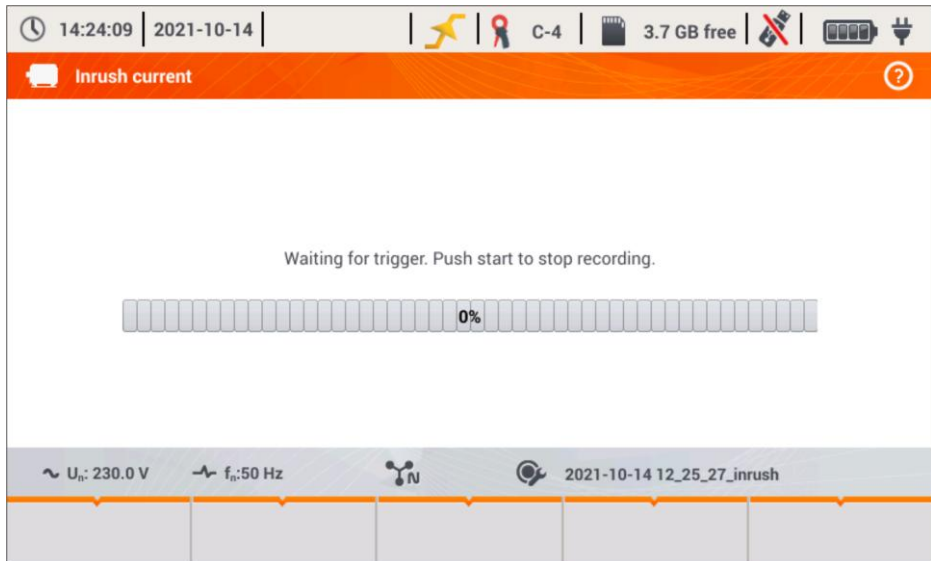

**Fig. 41. Inrush current - waiting for triggering the measurement.**

After the time elapses, the recording process ends and the analyzer automatically starts the analysis of measured inrush parameters, displaying the timeplot with current waveforms for the entire recording interval.

An example of the screen displayed during the start-up of a 3-phase motor is shown in Fig. 42.

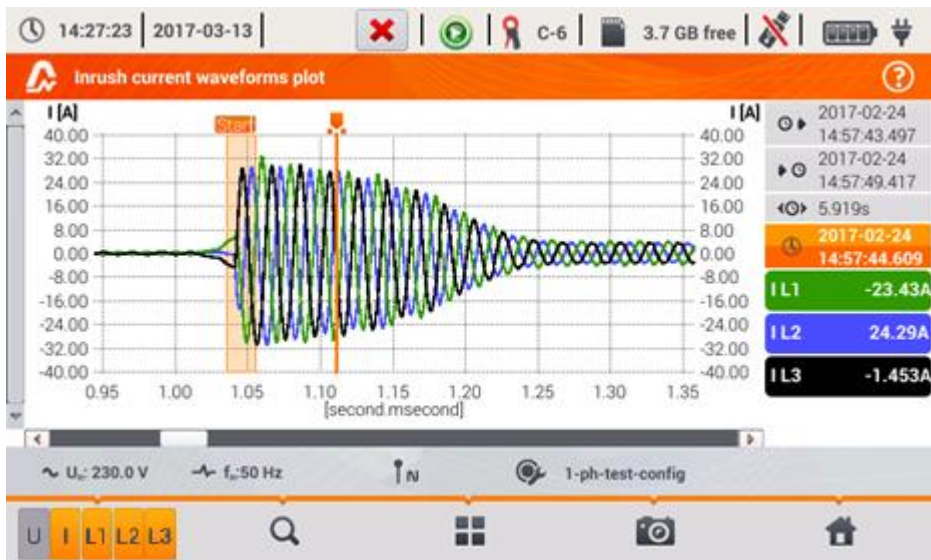



**Fig. 42. Inrush current analysis – waveforms plots.**

The window with a waveform of inrush current is similar to windows showing other plots. On the right side you may find the time of starting, ending and duration of the plot, the marker parameters and the buttons of active current channels, which indicate the current value at the marker point and allow user to enable and disable the display of individual channels.

### Menu bar function

 - switching the view. After clicking it, an additional menu bar is displayed with options (available depending on the current view):

 - Inrush RMS plot (Fig. 43; option available in waveforms and table view). Selecting this option displays a plot of  $RMS_{1/2}$  values of the measured currents.

 - plot of inrush waveforms (Fig. 42; option available in the view of a plot for  $RMS_{1/2}$  and as a table).

 - tabular view of inrush characteristic values (Fig. 44). The table displays the maximum  $RMS_{1/2}$  values and values of Joule integral determined for measured current channels.

Files of recorded inrush current measurement sessions are automatically saved on the memory card and they are available for re-analysis from the main screen after entering **RECORDING ANALYSIS**. Recorded sessions are marked on the list by icon  and their names are the same as the name of the configuration (default or entered by the user).



Fig. 43. Inrush current analysis – Inrush RMS plot.

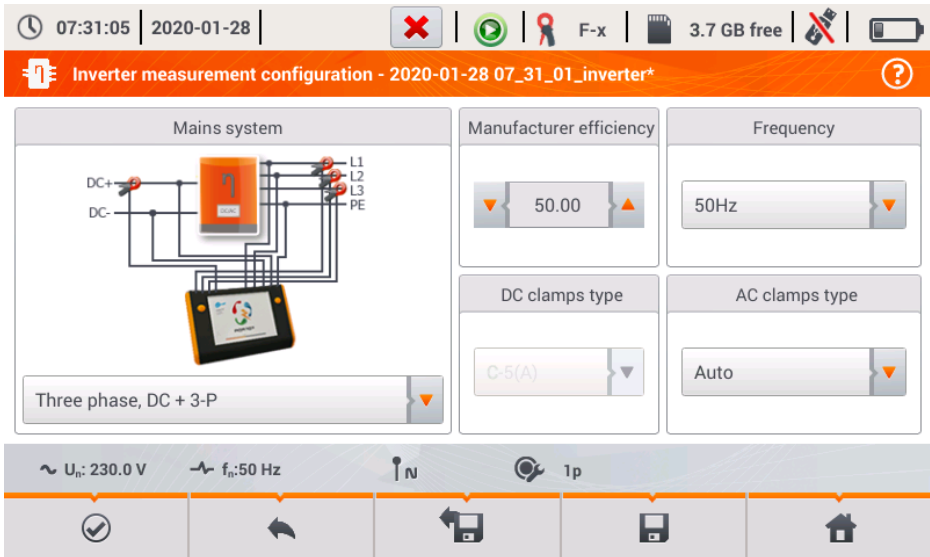

Fig. 44. Inrush current - characteristic parameters.

## 2.13 Measuring the efficiency of the inverter

### 2.13.1 Measurement configuration

Inverters are widely used, e.g. in photovoltaic installations or systems of uninterruptible power supply (UPS). The analyzer enables the user to check the efficiency of inverters in electricity processing i.e. converting a DC voltage into single-phase or three-phase AC voltage. To enter this function, select on the main screen of the meter the following: **SPECIAL FUNCTIONS** and then **INVERTER EFFICIENCY**.



**Fig. 45. Configuration screen of inverter efficiency measurement.**

Set the parameters of the tested inverter on the displayed configuration screen:

- **MAINS SYSTEM** – there are two types to choose from:
  - **SINGLE PHASE, DC + 1-P**  
 Select this system type for inverters with single-phase AC output. The screen will show a simplified diagram of the analyzer connection to the tested circuit:
    - DC+ voltage input of the inverter must be connected to 'N' input of the analyzer
    - DC- input of the inverter must be connected to L3 input,
    - AC voltage side of the inverter must be connected between L1 and PE inputs of the analyzer,
    - current of DC side of the inverter is measured with DC clamps connected to N input of the clamps. **Note: it is necessary to use clamps for DC measurements; these clamps are C-5A,**
    - current of AC side of the inverter is measured with clamps connected to L1 input of the analyzer. The user may specify any type of clamps compatible with the analyzer.

- **THREE PHASE, DC + 3-P**

It is possible to measure only the efficiency of three-phase, three-wire inverters (delta or star configuration without neutral wire). Please note that due to the limited number of voltage inputs in the analyzer, it is not possible to directly measure all phase-to-phase voltages. Therefore, the measured parameters on AC side are presented as approximate values, with accuracy depending on the symmetry of the output voltages of the inverter. If it works in such systems, verify voltage asymmetry before the efficiency measurement (negative sequence unbalance  $U2/U1$  should be less than 1%). This verification should be carried out by configuring and connecting the meter in a standard way to a three-phase network 3-P (after exiting function **INVERTER EFFICIENCY**). The asymmetry of currents on AC side is not relevant, as these currents are measured directly.

How to connect the analyzer:

- DC+ voltage input of the inverter must be connected to 'N' input of the analyzer
  - DC- input of the inverter must be connected to L3 input,
  - AC voltage side of the inverter: L1 and L2 outputs of the inverter must be connected respectively to the L1 and L2 inputs of the analyzer. PE input of the analyzer must be connected to the inverter ground or to a local ground, if the inverter has no grounding connection,
  - current of DC side of the inverter is measured with DC clamps connected to N input of the clamps. **Note: it is necessary to use clamps for DC measurements; these clamps are C-5A,**
  - currents of AC side of the inverter are measured with clamps connected to L1, L2 and L3 inputs of the analyzer. The user may specify any type of clamps compatible with the analyzer.
- **MANUFACTURER EFFICIENCY** – efficiency of the inverter declared by the manufacturer. This value is used to compare the measured efficiency with the declared value.
  - **DC CLAMPS TYPE** – this is a read-only field. The type of clamps is set to C-5A.
  - **AC CLAMPS TYPE** - the user may use the list to select the type of clamps used for current measurements on AC side of the inverter.
  - **FREQUENCY** – nominal frequency of the AC output of the inverter.



After setting the required parameters, you can go directly to the required measurements.

**Note:** Pay attention to the fastening direction of current clamps. After entering relevant measurements, check that the indicated active powers have positive value. Otherwise, the indicated efficiency may have incorrect sign.

### Menu bar functions

 - entering the measurement screen (live values in a tabular view) with the specified settings (without saving the configuration).

 - saving the configuration of inverter efficiency to a file with an option to start the measurement directly after saving (field [Go to Live mode](#) in the pop-up window).

 - entering the list of saved configurations of inverter efficiency and creating a new configuration. Configurations are presented similarly to the measuring configurations, they have their own icon . Double-click on a selected configuration will open it automatically and entering the

screen with inverter efficiency settings (**Fig. 46**). The button in the menu bar **+** is used for adding new configurations starting of the inrush current (a window is displayed, as shown in **Fig. 47** with default settings). Icon  is used to edit the chosen configuration of the inrush current.

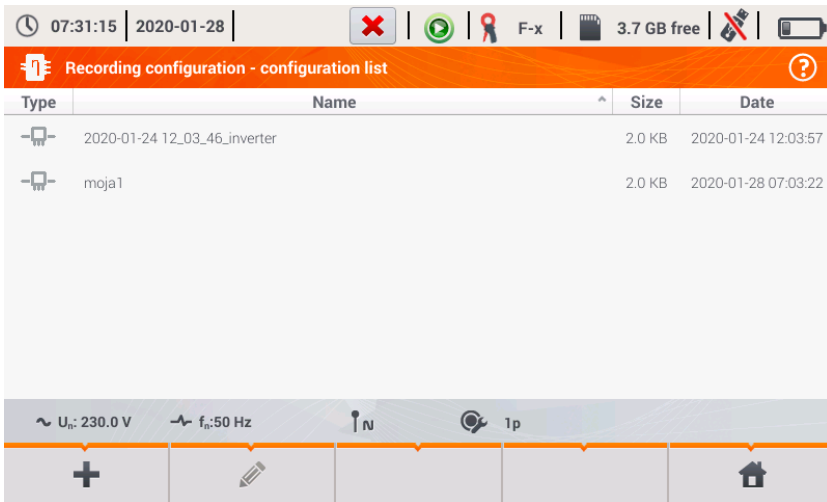

**Fig. 46.** Menu of recording configuration

### 2.13.2 Live mode

After entering the live mode screen, all the parameters of the measured inverter circuit are shown in a tabular view.

	$\eta_m$ [%]	$\eta_d$ [%]	U [mV]	$U_{h01}$ [mV]	$U_{bc}$ [mV]	f [Hz]	I [mA]
AC/DC	-0.370	50.37	---	---	---	---	---
DC	---	---	29.79	---	20.60	---	726.6
L1	---	---	30.53	2.312	-23.82	---	46.22
L2	---	---	---	---	---	---	---
L3	---	---	---	---	---	---	---
N	---	---	---	---	---	---	---
L1-2	---	---	---	---	---	---	---
L2-3	---	---	---	---	---	---	---

**Fig. 47.** Live mode in tabular view for the inverter efficiency measurement mode.

- **AC/DC** line:

- column  $\eta_m$  displays the efficiency value  $\eta_m$  of the inverter as the ratio of the active power of AC side to active power of DC side:

$$\eta_m[\%] = \frac{P_{AC}[W]}{P_{DC}[W]} \cdot 100 \%$$

- column  $\eta_d$  shows the difference between the measured and declared efficiency of the inverter:



$$\eta_d[\%] = \eta_{nom}[\%] - \eta_m[\%]$$

where  $\eta_{nom}$  is the declared efficiency of the inverter entered to the configuration screen.

- line **DC** presents the parameters of DC side of the inverter such as voltage, current, active power, active energy.
- values related to AC side are displayed in lines: **L1, L2, L3, N, L1-2, L2-3, L3-1** and  $\Sigma$ .

### Menu bar functions

It is possible to display the live values on three screens:

-  - view of waveforms of currents and voltages
-  - view of the time diagram,
-  - view of the table of measurements.

The control is similar to that described in Sec. 2.16 *LIVE mode of the network*. The differences include the option of displaying additional parameters: I DC, U DC, P AC, P DC on the screens for waveforms and timeplots.



**Fig. 48. Screens for waveforms and timeplots in the mode of inverter efficiency measurement**

## 2.14 Energy losses calculator

### 2.14.1 Functional Description

In this mode, you can estimate the loss of active power and associated costs due to poor power supply quality. The loss analysis screen is shown in **Fig. 49**. Analysis can be performed in terms of the desired time.



**Fig. 49. Energy loss analysis**

#### Parameters to analyse

$P_{opt}$  power loss due to wire resistance (assuming the absence of higher harmonics, unbalance and reactive power)

$P_{dis}$  losses due to higher harmonics

$P_{unb}$  power losses due to network unbalance

$P_{rea}$  power loss due to the presence of reactive power

$P_{tot}$  total losses (the sum of the above)

$P_{sav}$  losses which can be reduced by improving the quality parameters (e.g. compensation of harmonics, elimination of unbalance), arising from the relationship:

$$P_{sav} = P_{tot} - P_{opt}$$

$C_{opt}$  cost related to  $P_{opt}$  losses

$C_{dis}$  cost related to  $P_{dis}$  losses

$C_{unb}$  cost related to  $P_{unb}$  losses

$C_{rea}$  cost related to  $P_{rea}$  losses

$C_{pf}$  cost related to a low power factor (large share of reactive power)

$C_{tot}$  cost related to  $P_{rea}$  losses

$C_{sav}$  cost related to  $P_{sav}$  losses

The financial loss can be estimated based on the current readings in terms of:

- ⇒ one hour,
- ⇒ one day,
- ⇒ one month
- ⇒ one year.

When one of the above options is activated (  →  ), the table will display data relevant to the selection.

#### Description of function icons



going to the configuration panel of the loss calculator (**section 2.14.2**)



performing the screenshot



returning to the main menu of the recorder mode

### 2.14.2 Configuration of the loss calculator

After the icon has been selected, the calculator configuration panel appears, shown in **Fig. 50** and **Fig. 51**. It is possible to switch between screens using the icons.

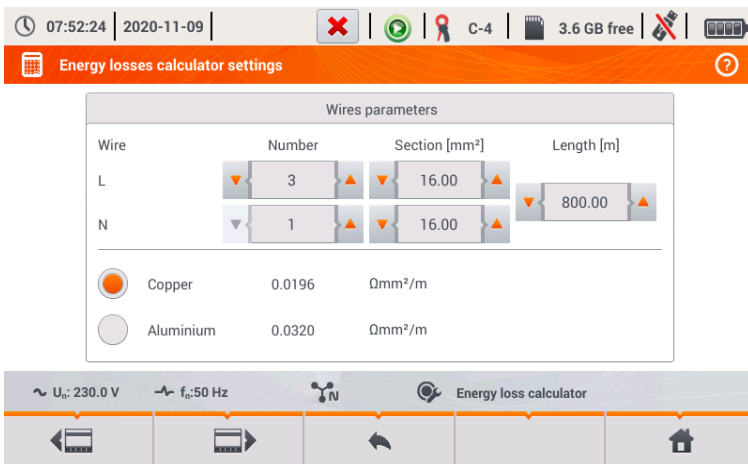
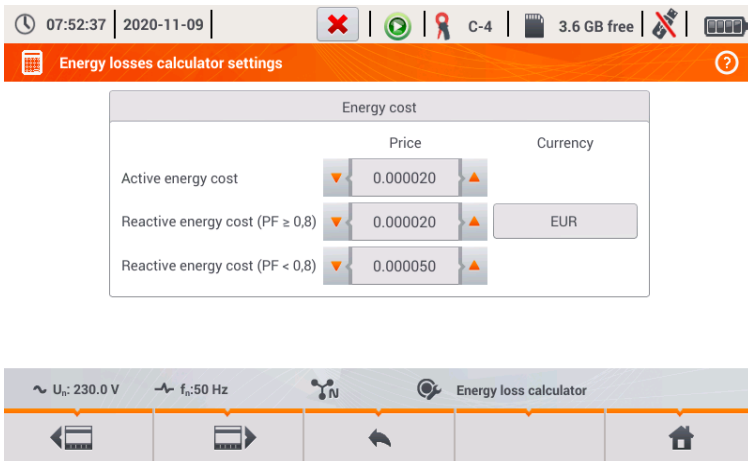

**Fig. 50. Energy loss analysis – configuration screen 1**

On the first screen, set the parameters of the wire, to which the analysis applies, namely:

- for phase conductors **L**:
  - o **NUMBER OF WIRES** in the phase,
  - o **CROSS SECTION** of cores in mm<sup>2</sup>,
- for neutral conductors **N**:
  - o **NUMBER OF NEUTRAL WIRES**,
  - o **CROSS SECTION** of cores in mm<sup>2</sup>,
- **THE LENGTH** of the analysed line in metres,
- **LINE MATERIAL** – copper or aluminium.

Based on the above parameters, the calculator will calculate the power loss in the analysed line.



**Fig. 51. Energy loss analysis – configuration screen 2**

On the second screen, set the parameters defining the financial loss, i.e:

- cost of 1 kWh of active energy,
- cost of 1 kWh reactive energy at power factor  $PF \geq 0.8$ ,
- cost of 1 kWh of reactive energy at power factor  $PF < 0.8$ ,
- currency.

To change the currency:

- tap the field with the current unit,
- enter a new unit using the on-screen keyboard.

#### Description of function icons

- ◀ ▶ switching between the two setting screens of the calculator.
- ↶ returning to the results indicated by the calculator. If the settings have been modified and saved, the results will be automatically calculated and displayed.
- 📄 recording calculator settings
- 🏠 returning to the main menu of the recorder mode

## 2.15 About analyzer

After selecting this section, a window is displayed with basic information about the software version of the analyzer and with manufacturer's details. Clicking on icon  in the menu bar displays detailed information about the version of the analyzer. On the screen with detailed information, after

connecting an external memory stick (USB flash drive) and clicking icon  in the bottom menu, the system log of the meter will be saved. This option is available for diagnostic purposes. The system log can be sent to the company's customer service in case of any problems with the meter.

## 2.16 LIVE mode of the network

The analyzer allows user to preview network parameters in real time (LIVE mode). Available views include the preview of voltage and current waveforms, timeplots of RMS values of voltages and currents, tabular view of parameters, phasor diagram and the harmonics view. If the default initial screen of the analyzer is the main screen (Fig. 2), then the bottom menu bar displays icons of individual views of LIVE mode:



- view of waveforms of currents and voltages,



- timeplot view,



- view of the table of measurements ,



- view of the phasor diagram,



- view of harmonics.

In this mode refreshing of the display can be temporarily blocked by using the function **HOLD** (see the top bar description in section 2.8.1). Clicking the **H** button pauses the refreshing (the icon color switches to red). Tapping the button for the second time re-enables refreshing (the icon color switches to black).

### 2.16.1 Waveforms of voltages and currents

View of waveforms for instantaneous currents and voltages is selected from the main screen using icon  in the bottom bar. They show two cycles of network waveforms for active channels (depending on the measurement configuration). An example of the screen is shown in Fig. 52. Use buttons on the right side of the window to switch on/off individual measuring channels (at least one waveform must be always visible). The buttons include the name of the channel, for example. "U L1" and its RMS value. Waveforms areas can be zoomed-in vertically and horizontally by double-click and scrolled. Waveforms return to their default size after turning on/off any channel (buttons on the right side).

**Note:** In DC systems (DC and DC+M) this view is not available.

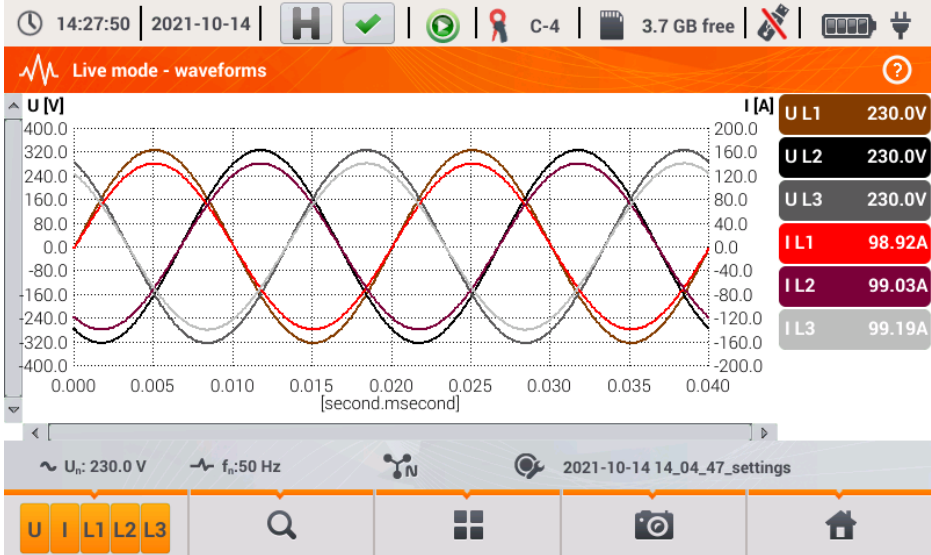









Fig. 52. Current readings - waveforms.

### Menu bar functions

 - icon of active channels. After clicking, an additional menu bar is opened with buttons for enabling or disabling the display of current and voltage channels. The active channel is indicated by orange colour of the button. Remember that the screen must display at least one waveform (you can not turn off all of them). The menu displays only the buttons of channels that exist in the mains system.

 - zoom-in icon. Click it to open an additional menu bar with icons for zooming-in the graph horizontally and vertically. Holding the zooming icon for 2 seconds results in the maximum zoom-in/out.

-  - zoom-in horizontally
-  - zoom-out horizontally
-  - zoom-in vertically
-  - zoom-out vertically

 - icon for selecting the view type. It displays the additional menu, where you can change the view type of LIVE mode.

 - screenshot icon. Clicking it saves the current contents of the main window to a graphic file. The file name is automatically created basing on the view name and the current date, for example "Live mode - waveforms - 2016-08-01 12\_00\_00". Files are stored on a microSD card.

### 2.16.2 Timeplot of RMS values

Timeplot view (Fig. 53) is activated from the main screen using icon . This view displays a graph of the RMS values of voltages and currents in time. In DC and DC+M systems the chart presents DC values of voltages and currents. The whole window covers time of approx. 110 seconds. After filling the entire window, the chart moves to the left by 30 seconds.

#### Menu bar functions

The same as for waveforms view.

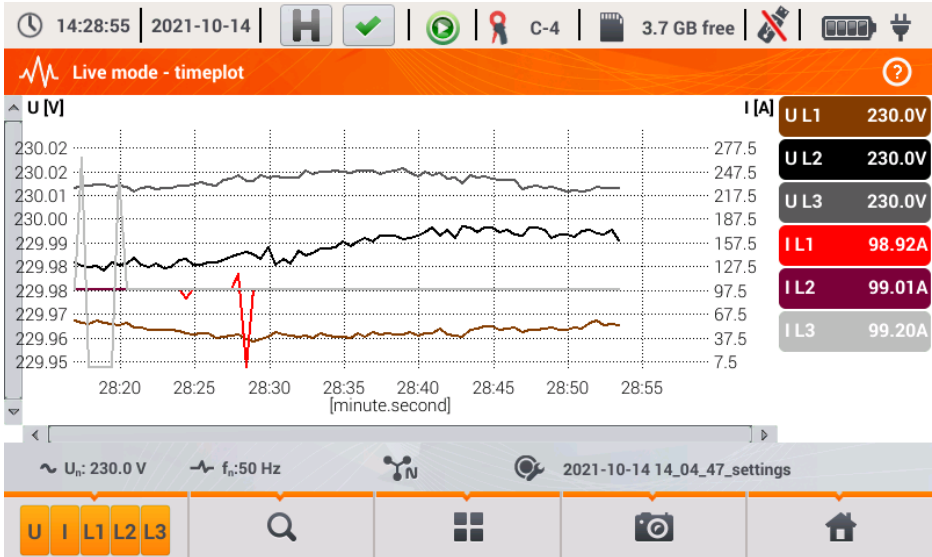

Fig. 53. Live mode – timeplot.

### 2.16.3 Live mode – tabular view

To view a table with values of mains parameters, select icon  in the main screen. After selecting it, the summary table is displayed with the values of the tested mains, refreshed in real time. An example of the screen is shown in Fig. 54.



Fig. 54. Live mode – measurements results table.

The next lines were determined as follows:

**L1** – phase values L1,

**L2** – phase values L2,

**L3** – phase values L3,

**N** – voltage values of channel U<sub>NPE</sub> and current channel I<sub>N</sub>,

**L1-2** – phase-to-phase values L1-2,

**L2-3** – phase-to-phase values L2-3,

**L3-1** – phase-to-phase values L3-1,

**Σ** – total values.

The next column show the values of individual parameters:

**U [V]** – RMS voltage,

**Uh01 [V]** – RMS of the fundamental voltage component,

**UDC [V]** – DC voltage,

**f [Hz]** – mains frequency,

**I [A]** – RMS current,

**Ih01 [A]** – RMS of the fundamental current component,

**IDC [A]** – DC current,

**P [W]** – active power,

**Q1** or **QB [var]** – reactive power of the fundamental component or reactive power, acc. to Budeanu (depending on the method of calculating reactive power),

**S [VA]** – apparent power,

**SN [VA]** or **D [var]** – apparent distortion power or Budeanu distortion power (depending on the method of calculating the reactive power),

**EP+ [Wh]** – active energy consumed,

**EP- [Wh]** – active energy supplied,

**EQ1+** or **EQB+ [varh]** – reactive energy consumed,

**EQ1-** or **EQB- [varh]** – reactive energy supplied,

**ES [VAh]** – apparent energy,

**PF** – Power Factor ,

**cosφ** – Displacement Power Factor,

**tanφ** – tangentφ factor,

**THDU [%]** – Total Harmonic Distortion for voltage (referred to the fundamental component),

**THDI [%]** – Total Harmonic Distortion for current (referred to the fundamental component),

**CFU** – voltage Crest Factor,

**CFI** – current Crest Factor,

**PST** – short-term flicker severity,

**PLT** – Long-term flicker severity,

**U0 [V]** – zero sequence symmetrical component of voltage,

**U1 [V]** – positive sequence symmetrical component of voltage,

**U2 [V]** – negative sequence symmetrical component of voltage,

**U2/U1 [%]** – voltage negative sequence unbalance factor,

**U0/U1 [%]** – voltage zero sequence unbalance factor,

**I0 [A]** – zero sequence symmetrical component of current,

**I1 [A]** – positive sequence symmetrical component of current,

**I2 [A]** – negative sequence symmetrical component of current,

**I2/I1 [%]** – current negative sequence unbalance factor,

**I0/I1 [%]** – current zero sequence unbalance factor.

### Menu bar functions



- moving to the next screens with parameters.



- icon for selecting the view type. It displays the additional menu, where you can change the view type of LIVE mode.



- screenshot.

### 2.16.4 Phasor diagram

The view of the phasor diagram is opened when you select icon  in the main screen. Phasor graph (e.g. in Fig. 55) shows the basic layout of component vectors of voltages and currents. It may be used to quickly verify the correctness of connecting the analyzer to the network. In addition to the diagram, the tables include information about the values of fundamental components and their angles, as well as two unbalance factors of negative components (factors are displayed only for 3-phase networks). The type of the load is indicated by a coil icon (inductive load) if the angle between the fundamental voltage and current components ( $\varphi_{U_{h1}, I_{h1}}$ ) is greater than zero (voltage ahead of the current), and by a capacitor icon (capacitive load) if this angle is negative (current ahead of voltage).

**Note:** In DC systems (DC and DC+M) this view is not available.

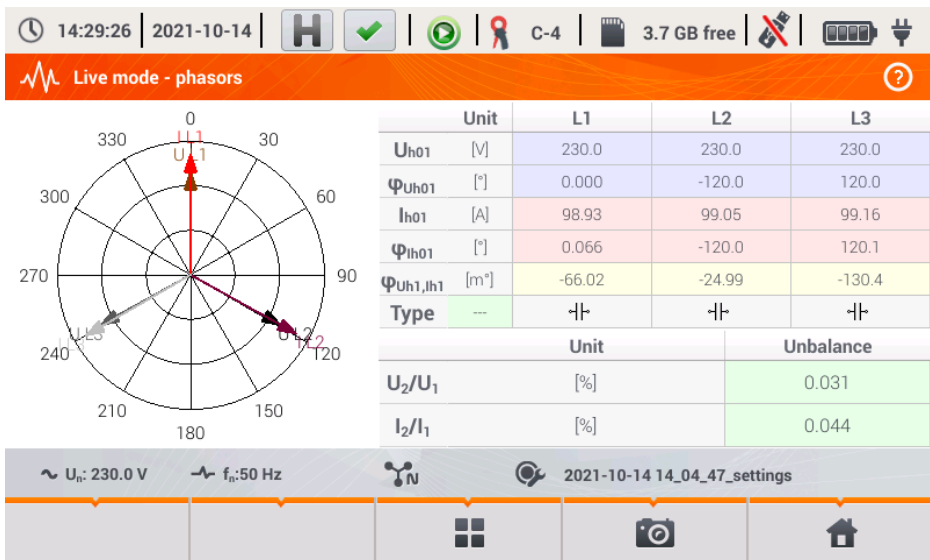



Fig. 55. Live mode – phasor diagram.

#### Menu bar functions

 - icon for selecting the view type. It displays the additional menu, where you can change the view type of LIVE mode.

 - screenshot.

### 2.16.5 Harmonics graph/table

The last view of the Live mode presents harmonics. This view is selected by clicking icon from the main screen. This screen allows you to view the harmonics of voltages and currents, angles between the current and voltage harmonics,  $\cos\phi$  factors of these currents and THD factors. Harmonics are displayed graphically in a bar graph or in a table. By default, the harmonics are presented in a bar graph. An example is shown in Fig. 56.

**Note:** In DC systems (DC and DC+M) this view is not available.

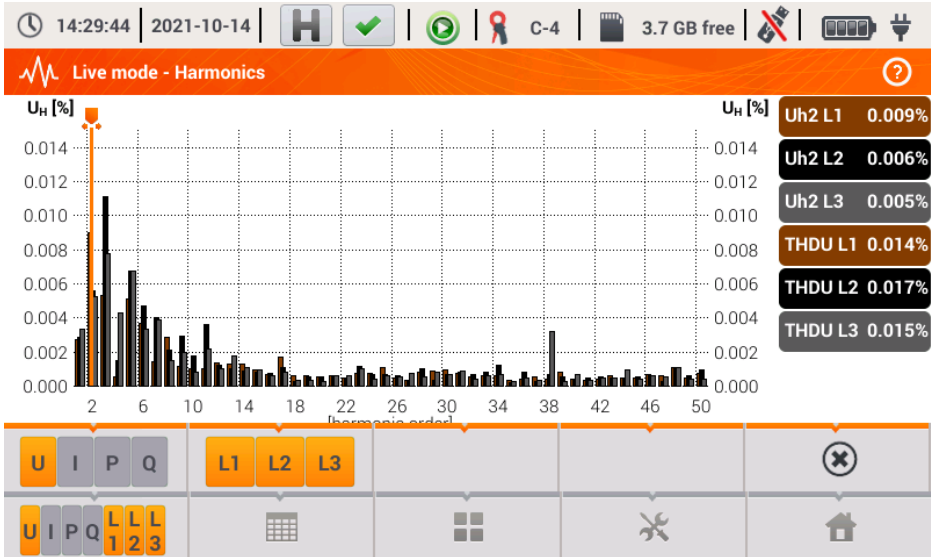

Fig. 56. Live mode - harmonics - bar graph.

#### Menu bar functions

- menu of active channels. After clicking, an additional menu bar is opened with buttons for enabling or disabling the data and to switch between current and voltage harmonics. Icon (available only in table view) enables preview of angles between voltage and current harmonics, together with the calculated values of  $\cos\phi$  angles. The active channel is indicated by orange colour of the button.

- switching to tabular view of harmonics (Fig. 57). The table in each row displays the harmonic values (from DC component to the harmonic of 50th order) or the angles between the current and voltage harmonics. In case of harmonics, the values may be displayed in absolute units (V/A), or as percentage related to the fundamental harmonic (see below). The angles are given in degrees. The powers of harmonics – in % or W/var.

In the tabular view, the buttons on the right side of the window shows the RMS values of voltages and currents.

- switching to the bar graph. The chart includes a marker, which indicates the order of harmonic(s), the value of which is shown on the button on the right side of the window. In addition, THD factor is also displayed at the right side.

 - icon for selecting the view type. It displays the additional menu, where you can change the view type of LIVE mode.

 - options menu for a chart or table. After selecting it, an additional menu bar is displayed, which provides several new options:

 - an option of hiding the fundamental harmonic.

**[V,A]** - displaying values in absolute units (volts and amps).

**[%]** - displaying values as percent in relation to the fundamental component.

 - screenshot.



Fig. 57. Live mode - harmonics - tabular graph.

## 2.17 Operation with PC

### 2.17.1 "Sonel Analysis" software

*Sonel Analysis* is an application used to work with power analyzers of PQM series. When used with PQM-707, it provides the following features:

- read data from the device,
- real-time preview of the mains (live view),
- present data in the tabular form,
- present data in the form of graphs,
- analysing data for compliance with EN 50160 standard (reports) and other user-defined conditions,
- updating firmware of analyzer and updating the application itself.



The software operates with Windows 7, Windows 8 and Windows 10.

Detailed manual for "*Sonel Analysis*" is available in a separate document (also downloadable from the manufacturer's website [www.sonel.com](http://www.sonel.com)).

### 2.17.2 PC connection and data transmission

The analyzer allows communication with a PC when connected to it with USB cable.

Connection to a computer (PC mode), ensures:

- transmission of data stored in the recorder memory:
  - it is possible to read data from all completed recordings,
- viewing mains parameters on PC:
  - instantaneous values of: current, voltage, power and energy, total values for the entire system,
  - harmonics, THD,
  - unbalance,
  - phasor diagrams for voltages and currents,
  - current and voltage waveforms drawn in real-time,
  - all other measured parameters.
- When connected to a PC, the display shows message "PC Connection"
- When connected to a PC, all analyzer buttons are locked except  button, but when the analyzer operates with key lock mode (e.g. during recording), all the buttons are locked. The icon , located in the menu bar, terminates the connection with the PC.
- When within 10 seconds of connecting a PC to the device no data exchange occurs between the analyzer and the computer, the analyzer exits data exchange mode and terminates the connection.

*Sonel Analysis* software also allows you to read data directly from a microSD card using an external memory card reader. This method allows for the fastest reading of the recorded data. To use this mode, remove the memory card from the meter and insert it into a reader connected to the computer (when removing the card, follow the rules described in sec. 2.6; it is safe to turn off the meter before that).

## 2.18 Wiring diagrams

The analyzer may be connected directly to the following types of AC networks:

- single-phase (Fig. 58)
- split-phase with split-winding of the transformer (Fig. 59),
- 3-phase 4-wire, 3-phase 4-wire (no U L2) / 2 ½ element (no V L2/B) (Fig. 60),
- 3-phase 3-wire, 3-phase 3-wire Aron / 2-element, 3-phase open delta (Fig. 61, Fig. 62).

Indirect measurement in MV and HV networks is possible:

- in 3-phase 4-wire system (Fig. 63),
- in 3-phase 3-wire system (Fig. 64).

Measurements in DC systems is possible in two configurations:

- DC – one-voltage DC system (Fig. 65)
  - DC+M – two-voltage DC system with middle point (Fig. 66)
- In DC systems, it is possible to measure the current using probes C-5A.

In three-wire AC systems, current may be measured by the Aron method (Fig. 62), which uses only two probes that measure linear currents  $I_{L1}$  and  $I_{L3}$ .  $I_{L2}$  current is then calculated using the following formula:

$$I_{L2} = -I_{L1} - I_{L3}$$

In systems with neutral conductor, the user may additionally activate current measurement in this conductor, after installing additional probes in  $I_N$  channel. This measurement is performed after activating "N conductor current" option in the configuration.

### Note

*In order to correctly calculate total apparent power  $S_e$  and total Power Factor (PF) in a 4-wire 3-phase system, it is necessary to measure the current in the neutral conductor. Then it is necessary to activate option **N conductor current** and connect 4 probes, as shown in Fig. 60. More information on total apparent power  $S_e$  - see Power Quality Guide document.*

For systems with available PE and N conductors (earthing and neutral) it is also possible to measure N-PE voltage. To do this, connect PE conductor to PE input of the analyzer. In addition, select option **N-PE voltage** in measurement point settings.

Pay attention to the direction of current probes. The probes should be installed with the arrow indicating the load direction. It may be verified by conducting an active power measurement – in most types of passive loads active power is positive. When probes are inversely connected, it is possible to change their polarity using in software (**ANALYZER SETTINGS → PROBES**)

The following figures show schematically how to connect the analyzer to the tested network depending on its type.

Icons used in the drawings with respect for optional connections have the following meanings:



if voltage  $U_{N-PE}$  measurement is required, use this icon to connect as shown in diagram (connect PE input to the protective conductor)

 if current  $I_N$  measurement is required, use this icon to connect as shown in diagram (connect probes in channel  $I_N$ ).

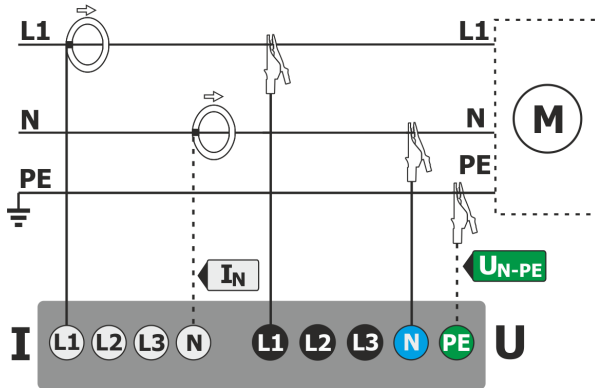

Fig. 58. Wiring diagram – single phase.

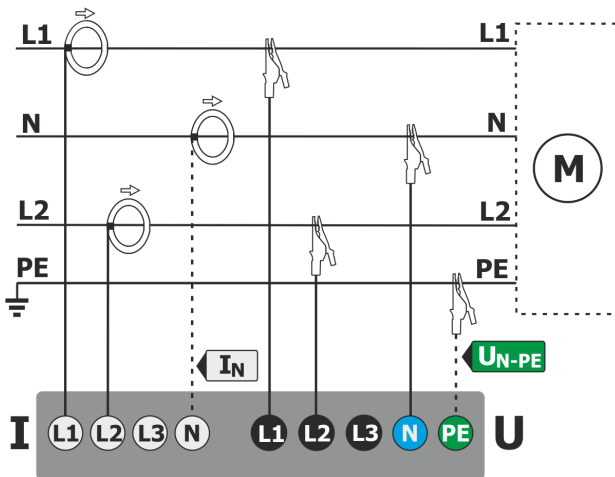

Fig. 59. Wiring diagram – split-phase.

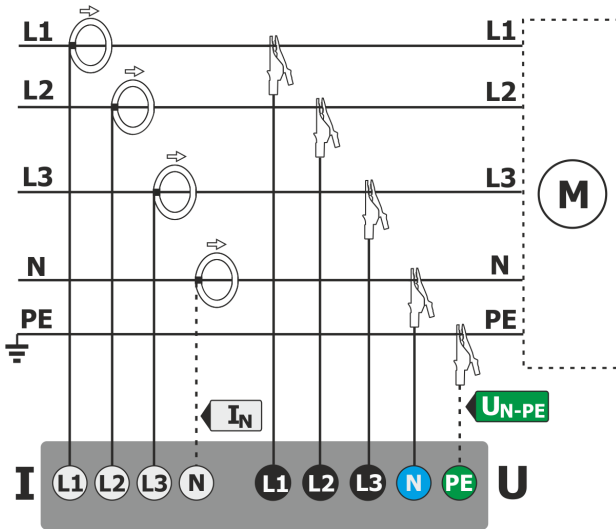

Fig. 60. Wiring diagram – 3-phase 4-wire, 3-phase 4-wire (no U L2) / 2 ½ element (no V L2/B) systems.

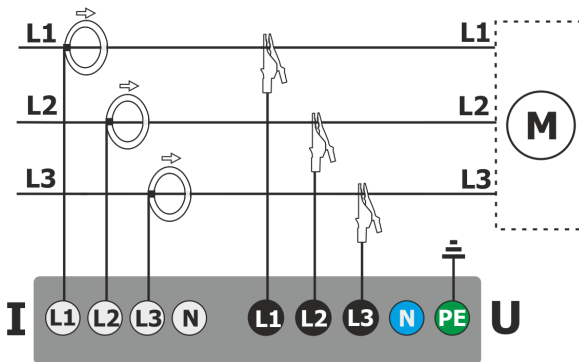

Fig. 61. Wiring diagram – 3-phase 3-wire, 3-phase open delta systems.

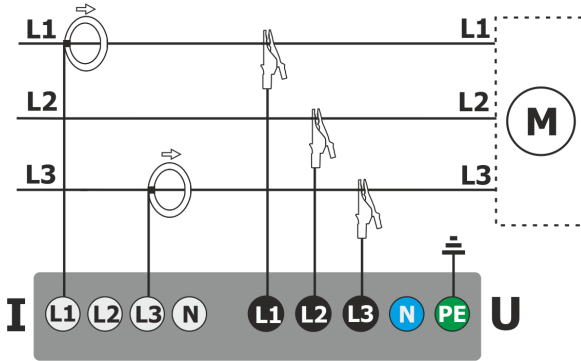

Fig. 62. Wiring diagram – 3-phase 3-wire Aron, 2-element systems (current measurement using Aron method).

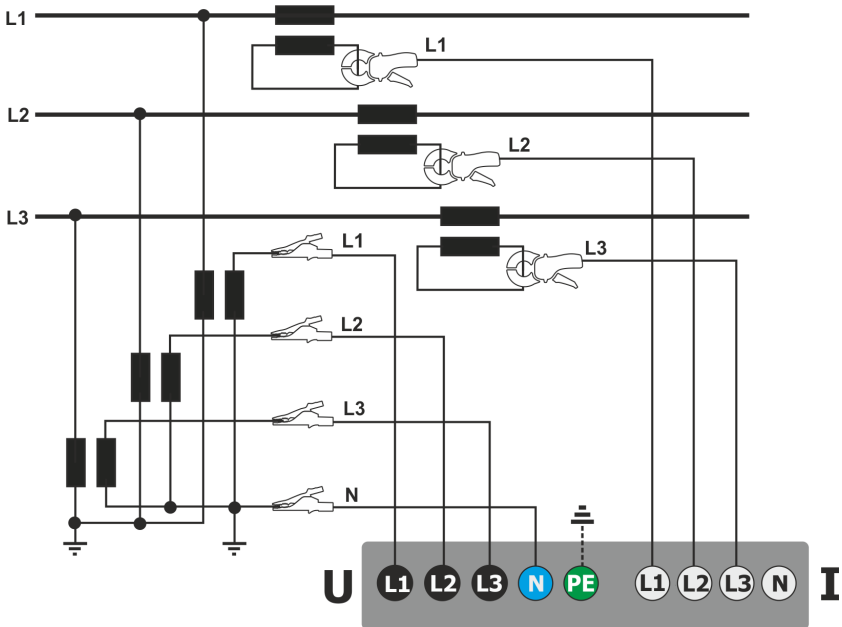

Fig. 63. Wiring diagram – indirect measurement of MV in 3-phase 4-wire system.

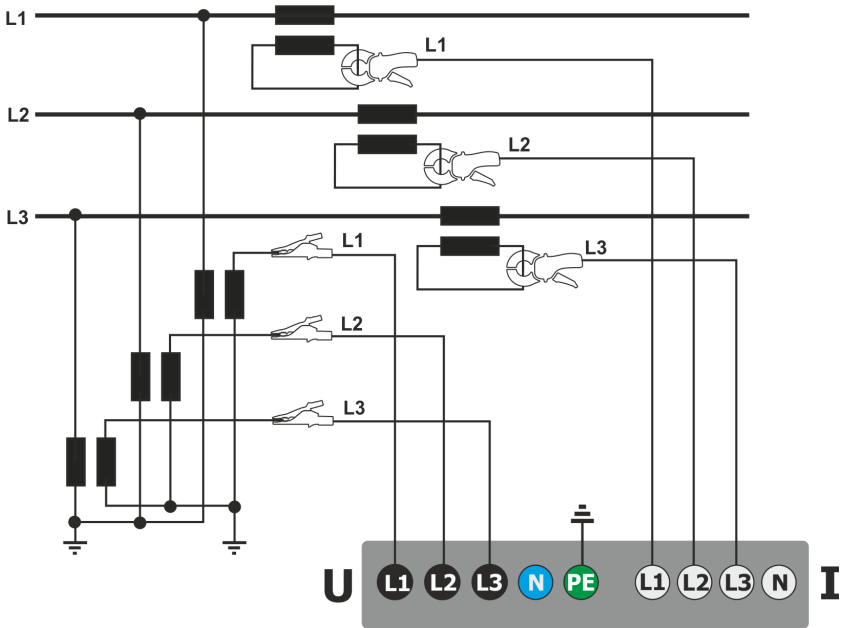

Fig. 64. Wiring diagram – indirect measurement of MV in 3-phase 3-wire system.

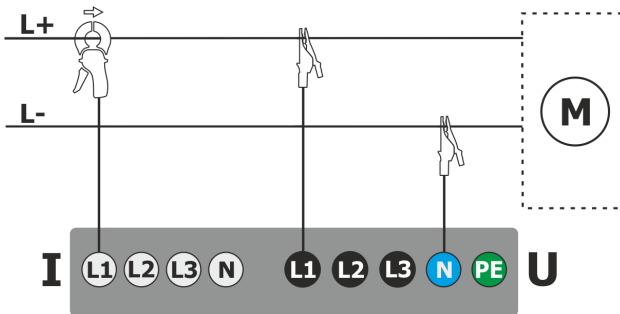

Fig. 65. Wiring diagram – DC system.

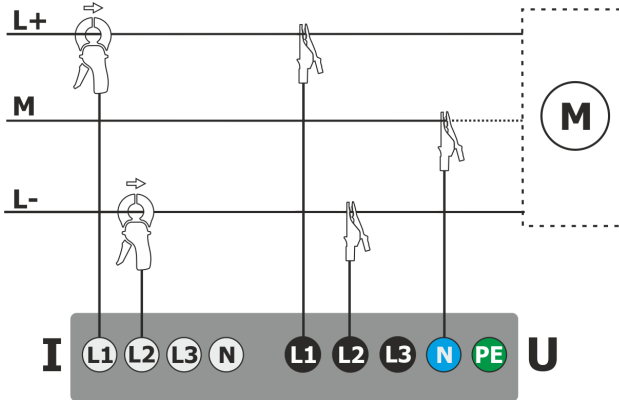

Fig. 66. Wiring diagram – DC+M system (bipolar).







### 2.18.1 Verifying the connection

After clicking the button that is signalling the correct connection of the analyzer (see Fig. 3) a window is displayed showing some important information on the connection of the analyzer to the tested network. This information helps the user to verify the compliance of the current configuration of the analyzer with the parameters of the measured network. The window provides the following information:







- Voltage values - two possible icons:
  - - RMS voltages are correct, they are within the tolerance range of  $\pm 15\%$  of the nominal voltage,
  - - RMS values are outside the range of  $U_{NOM} \pm 15\%$ .
- Current values - four options:
  - - RMS currents are in the range of  $0.3\% I_{NOM} \dots 115\% I_{NOM}$ ,
  - - RMS currents are lower than  $0.3\% I_{NOM}$ ,
  - - RMS currents are higher than  $115\% I_{NOM}$ ,
  - --- dashes are displayed when the current measurement is disabled in the configuration.

In 3-phase 3- and 4-wire systems the analyzer also calculates the sum of all the currents (instantaneous values) and checks if it totals to zero. This helps in determining if all current probes are connected correctly (i.e. arrows on current probes facing to the load). If the calculated current sum RMS value is higher than  $0.3\%$  of  $I_{NOM}$  it is treated as an error and the icon is displayed.

- Voltage vectors - the analyzer verifies the correctness of the fundamental components angles and displays the corresponding icon:
  - - the vectors have correct angles in the range of  $\pm 30^\circ$  of the theoretical value for a resistive load and symmetrical circuit (in 3-phase systems),
  - - the accuracy of angles cannot be verified, because the RMS voltage value is too low (less than  $1\%$  of  $U_{NOM}$ ),
  - - incorrect angles of vectors. In three-phase systems, this icon is displayed, among others, in case of reversed sequence of voltage phases.

- Current vectors - correctness of vector angles is verified for the fundamental components of main currents in relation to the voltage vectors. The following icons are displayed:
  -  - vectors are within  $\pm 55^\circ$  in relation to angles corresponding to the voltage vectors,
  -  - the accuracy of current vector angles cannot be verified, because the RMS current values are too low (below 0.3% of  $I_{NOM}$ ),
  -  - vectors are outside the acceptable range of angles ( $\pm 55^\circ$ ),
  - --- dashes are displayed when the current measurement is disabled in the configuration.
- Frequency:
  -  - the measured grid frequency is in the range of  $f_{NOM} \pm 10\%$ ,
  -  - the RMS value of reference voltage phase is lower than 10 V or there is no PLL synchronization,
  -  - the measured frequency is outside of  $f_{NOM} \pm 10\%$  range.

The icon is displayed in the top control bar in the following way:

-  - if the table includes is at least one ,
-  - if the table includes is at least one , but there is no error (no ) ,
-  - if all measured parameters are correct.

## 2.19 Example of use

The procedure presented below shows how to make a measurement with the analyzer ('step by step'): from connecting the device to generating the measurement report. It provides guidelines how to quickly start to operate the analyzer and *Sonel Analysis* software. It is assumed that *Sonel Analysis* software is already installed.

### Scenario: 1-phase measurement for compliance with EN 50160.

Measurement scenario is as follows: the user wants to measure voltage parameters of single-phase network 230 V 50 Hz. The goal is to generate a report on compliance with the requirements of standard EN 50160. In accordance with the requirements of the standard, the following parameters should be recorded:

- 10-minute average values of voltage, THD and harmonics,
- frequency of 10 seconds,
- long-term flicker severity  $P_{LT}$ ,
- voltage events: 110% $U_{nom}$  for swell, 90% $U_{nom}$  for dip, 5% $U_{nom}$  for interruption. When an event is detected, the waveform and RMS<sub>1/2</sub> graph must be recorded.

After the measurement, generate timelines of measured parameters and a sample report for compliance with the standard. Data should be saved for further analysis.





This above activities shall be done using only the analyzer.





Additionally, read the saved data stored in *Sonel Analysis* software and generate a report on compliance with the standard.

### How to perform the measurements:



**Step 1: Turn on the meter.** Turn on the analyzer by pressing  button. After loading the software, a screen should be displayed as shown in Fig. 2 or one of the LIVE mode screens, if the default screen has been changed in the configuration.

**Step 2: Connect to the tested network.** Connect the analyzer to the tested mains, as shown in Fig. 58. Connect voltage inputs L1, N. Probes do not need to be connected, because the current measurement is not required. Connect an external power supply to the analyzer to avoid supplying from the battery pack that may be interrupted due to the discharged battery.

**Step 3: Create a new measurement configuration.** Select **RECORDING CONFIGURATION** in the main screen. In the next few steps a new measurement configuration is created, according to the specified requirements. From the bottom bar menu, select icon  (adding a new configuration). Then, in the displayed window select option **ACCORDING TO STANDARD** on from the drop-down list select standard **EN 50160 – LOW VOLTAGE**. Confirm your selection by clicking  icon on the menu bar. The first screen of detailed configuration will be displayed. From the drop-down list of **MAINS SYSTEM** select **1-phase**, voltage  $U_n$  leave 230/400 V, frequency 50 Hz and from list **PROBES TYPE** select **None**. On the other setup screens you do not need to make additional changes, so you can save the configuration by choosing 'Save' icon . A window will be displayed for entering the name for the newly created configuration. By clicking on the box with default name, you can enter your own name, for example „EN50160 1-ph“. After entering the name, tick box **Set as active** to switch the analyzer immediately to the new configuration and click **OK**. A window will be displayed to confirm saving of the configuration. The bottom information bar should include the following information:  $U_n$ : 230 V,  $f_n$ : 50 Hz, 1-phase mains icon  and the name of the new configuration.





**Step 4: Check the correctness of the connection.** Go to the main screen (icon ) , and then display the window with waveforms  . The main window should present the instantaneous voltage waveforms (sine wave), and the button on the right side should indicate the value of the RMS voltage, which should be approximately 230 V i.e. the same as the nominal value of the network set. You can also view check the tabular view of instantaneous parameters  and harmonics .





**Step 5: Check the readiness for recording.** Before starting recording, make sure that the date and time of the analyzer are correct and that the analyzer has microSD memory card installed with sufficient disk space. If the date is not correct, from the main screen select **ANALYZER SETTINGS** and then **DATE AND TIME**, enter correct values and confirm. If the correct memory card is inserted into the analyzer, the top bar will display a memory card icon with information about free space.



**Step 6: Data recording.** You can start recording by pressing  button. After the window for confirming recording start is displayed press **Yes**. Starting the recording will be confirmed by a triple beep and the saving icon in the top bar will turn red , whereas LED will flash in red. The meter should be left in this state for a long period e.g. a few hours to save the appropriate amount of data (in recording according to EN 50160 new records are saved every 10 minutes, and assigning P<sub>LT</sub> indicator requires recording that lasts full two hours synchronized with the clock that multiplies the period of two hours). During the recording process, an event of voltage dip may be simulated by disconnecting lead L1 or N from the meter for a while. To meet the regulatory requirements, recording process should be performed at least for the duration of one week.

**Step 7: Stop recording.** After the required time, stop the recording by pressing  and confirming the intention to stop the recording process.

**Step 8: Go to the recording analysis.** From the main screen select **RECORDING ANALYSIS** screen. Find the completed recording in the list of records: its name should be the same as the user's configuration, for example. *"EN50160 1-ph"* (in step 3), compare the date and time of completion with the current time of the meter. You can also sort the list by date, in order to display the latest recordings at the top of the list. Double-click the found recording or highlight it by single click, and select from the bottom menu preview icon  . You will see the recording summary screen.

**Step 9: Generate timeplots.** To generate an example of a timeplot with three waveforms: average voltage UL1, 10-second frequency (which are normally stored in all recordings according to standard) and flicker P<sub>LT</sub>, perform the following steps. On the recording summary screen, select waveform icon  in the bottom menu and then select icon  from the additional menu. A graph will be displayed with the average value of the voltage for the entire recording range. This screen is used to indicate the time range, which will be used to generated timeplots of user-selected parameters. Orange rectangle marks the active time range that may be moved to increase (up to the limit of 1,100 samples) or decrease the indicated range. After adjusting the time range, click option  in the bottom bar which means the selection of plotted parameters. Select the sample parameters (maximum four) for example average voltage UL1, frequency and voltage THD. After selecting the parameters, go to the bottom bar and click icon  to generate chart. The screen will display a window with the timeplot of selected parameters. The marker may indicate a specific time and provide the parameters in this time visible on the right side panel.

**Step 10. Generate report on compliance with standard.** From the graph window return to the recording summary screen (in the bottom bar select  and then , and then twice ). After that, to generate a report of compliance with standard EN 50160 (which was used for recording), click icon  in the bottom bar. Window with report options will be displayed (as in Fig. 27). After selecting the desired options, the icon  on the menu bar to generate a report. It will be displayed on the screen. Individual sections of the report are presented in sec. 2.11.7.

**Step 11. Saving report on the USB memory stick (flash drive).** To save the generated report on compliance with the standard in external USB memory, connect the flash drive to the analyzer, wait until the device is recognized, and the top bar should include a not uncrossed icon of USB flash drive. Then, in the menu bar click saving icon  and in additional menu that appears, click icon  to save the report. After a successful saving, a window will appear with confirmation. Report (in pdf format) will be saved on a removable drive in a folder named "PQM-707\_DATA".

**Step 12: Connect the meter with Sonel Analysis software.** First install this software. Once installed, you must start it and connect the analyzer to the computer using USB cable. If this is the first connection, wait to install the drivers of the analyzer. Select **Analyzer → Analysis** in the menu, or use the toolbar and select **Analysis** option. A window will be displayed with a list of available analyzers - the list should include one item with the detected PQM-707. Double click on the name of the analyzer to connect with it. After connecting, the analyzer screen will show window **PC connection**.

An alternative method to read the data by *Sonel Analysis*, is transferring the memory card into the card reader connected to a computer (for data safety, first turn off the meter, to save all data on the card). Select (similarly as above) **Analyzer → Analysis** in the menu, or use the toolbar and select **Analysis** option. A window will appear with a list of detected memory cards; the list should include item: "PQM-707 [serial number] - Connection with the memory card" of the detected card of the analyzer. Double-click twice on this item and then confirm the connection to continue.

**Step 13: Read the recording data from the analyzer.** As a result of selecting option **Analysis**, the software will display a window for choosing data type to be downloaded from the meter. It is possible to download the recording data (measurements) and screenshots. In such case, the recorded data will be downloaded, so you'll need to tick option **Recordings**. At this point, the program downloads from the meter a list of available recordings. The list includes all recordings that are currently stored on the microSD card of the analyzer. Indicate recording you want to download and click **Read data**. A window will appear showing data loading progress. After loading all data, a window is displayed for saving downloaded data into the disk. It is recommended to save the data to a desired location on the disk, in order to retrieve it for further analysis. Indicate the location on the disk, name the file and click **Save**. In the displayed window click on the horizontal bar indicating time of recording placed under text **Configuration No... (Standard)** (after clicking it turns orange) and then click **Data Analysis**.

**Step 14: Data Analysis.** In the main window of data analysis four main buttons are available: **General** (default view after loading data), **Measurement**, **Events**, **Configuration**. In **General** view, on the right side, icons are displayed representing individual measurements, event and recorded waveforms in the timeline. This graph with a large amount of data may be freely enlarged to get more details.

Click **Measurements** button to display table with the values of all measured parameters, according to selected averaging time. In this scenario, the recording according to standard was selected, where averaging time is always equal to 10 minutes, therefore every 10 minutes the analyzer recorded voltage, THD and harmonics (frequency is always measured every 10 seconds). Each line

contains the data recorded in the subsequent 10-minute interval and each column contains the individual parameters (all 10-second frequency values may be viewed after selecting '10s' from **Display data** list)

After pressing **Events** you may view all the recorded events. In this scenario, the following voltage values were recorded: swell, dip and interruption. Each row in the table corresponds to one detected event. When for a given event graphs are available (e.g. waveforms and RMS<sub>1/2</sub> graphs), as in this scenario, the last column contains the icon of saved graphs. After clicking it, the user may display graphs related to a given event.

**Step 15: Display the time plot for voltage and THD.** To generate the graph, go to **Measurement** view (click **Measurement** button), select column headings for voltage L1, THD L1 (columns will be highlighted) and then click **Plots** and choose **Time plot**. A window will be displayed with a graph containing two timeplots: L1 voltage and THD U L1. The graph may be freely enlarged, using the three markers mark specific points on the graph and read the parameters of indicated points. The graph may be saved (in selected graphic format) by clicking **Save** icon on the top toolbar.

**Step 16: Displaying graphs with harmonics.** Two types of graphs may be displayed for harmonics. The first one is a graph of recorded harmonics in time. To display the graph, select the columns of selected harmonics (e.g. third and fifth order) and click **Plots**→**Time plot**.

The second type of the graph is a bar graph of harmonics. It shows all the harmonics in 10-minute interval (in one line). To generate it, first select the desired cell from the time column and the select the column of any L1 voltage harmonic, click **Plots** and choose from **Harmonics** list. In the same manner, the user may also select the time interval by dragging time column cells. Then a graph is shown with average values of harmonics in the specified time period.

**Step 17: Checking events.** If the analyzer, during recording process, detects any event, it will be displayed in a table in **Events** view. The line describing the specific event displays time of the event (start and end), extreme value (e.g. minimum voltage during the dip), waveform and RMS<sub>1/2</sub> graph when the event was voltage- or current-related. In this scenario, event graphs were activated automatically in settings (due to setting the configuration in accordance with a standard), therefore when the analyzer detects any event, the last column of the table (with **Waveform** header) should include a graph icon. Click it to display graphs (or press button **Plots** and select **Waveform**).

**Step 18: Generate report on compliance with standard.** To generate a report summarizing the compliance of the tested mains parameters with standard requirements, in view **Measurements**, click **Reports** and select **Report according to standard**. The displayed window will enable you to set parameters of the generated report (e.g. processing of "flagged" data, taking into account phase-to-phase voltage, etc.). **Generate** button will start data processing and preparing the report. The last step is to provide additional data (optional), which will be added to the report (e.g. report number, description of the measurement, the author's details, graphic logo). To see the report, click icon **Preview**. Button **Save** saves data in a format specified by the user (*pdf, html, txt, csv*).

## 3 Design and measurement methods

### 3.1 Voltage inputs

The voltage input block is shown in Fig. 67. The phase inputs L1, L2, L3 can be referred to the neutral input terminal (the measured voltages are then L1-N, L2-N, L3-N), or the protective earth terminal PE (the measured voltages are then L1-PE, L2-PE, L3-PE). The particular reference is selected based on the mains type; the PE reference is used in 3-phase 3-wire systems, while the others use neutral input reference.

The analyzer has one voltage range, with voltage range  $\pm 1150V$  (no ADC saturation).

### 3.2 Current inputs

The analyzer has four independent current inputs with identical parameters. Current transformer (CT) probes with voltage output in a 1 V standard, or several types of flexible (Rogowski) probes, can be connected to each input.

A typical situation is using flexible probes with built-in electronic integrator. However, the PQM-707 allows connecting the Rogowski coil alone to the input and a digital signal integration.

### 3.3 Digital integrator

The PQM-707 uses the solution with digital integration of signal coming directly from the Rogowski coil. Such approach has allowed the elimination of the analog integrator problems connected with the necessity to ensure declared long-term accuracy in difficult measuring environments. The analog integrators must also include the systems protecting the inputs from saturation in case DC voltage is present on the input.

A perfect integrator has an infinite amplification for DC signals which falls with the rate of 20 dB/decade of frequency. The phase shift is fixed over the whole frequency range and equals  $-90^\circ$ .

Theoretically infinite amplification for a DC signal, if present on the integrator input, causes the input saturation near the power supply voltage and makes further operation impossible. In practically implemented systems, a solution is applied which limits the amplification for DC to a specified value, and in addition periodically zeroes the output. There are also techniques of active cancellation of DC voltage which involve its measurement and re-applying to the input, but with an opposite sign, which effectively cancels such voltage. There is a term "leaky integrator" which describes an integrator with finite DC gain. An analog leaky integrator is just an integrator featuring a capacitor shunted with a high-value resistor. Such a system is then identical with a low-pass filter of a very low pass frequency.

Digital integrator implementation ensures excellent long-term parameters – the entire procedure is performed by means of calculations, and aging of components, drifts, etc. have been eliminated. However, just like in the analog version, also here we can find the saturation problem and without a suitable counteraction the digital integration may become useless. It should be remembered that both, input amplifiers and analog-to-digital converters, have a given finite and undesirable offset which must be removed prior to integration. The PQM-707 analyzer firmware includes a digital filter which is to remove totally the DC voltage component. The filtered signal is subjected to digital integration. The resultant phase response has excellent properties, and the phase shift for most critical frequencies 50 and 60 Hz is minimal.

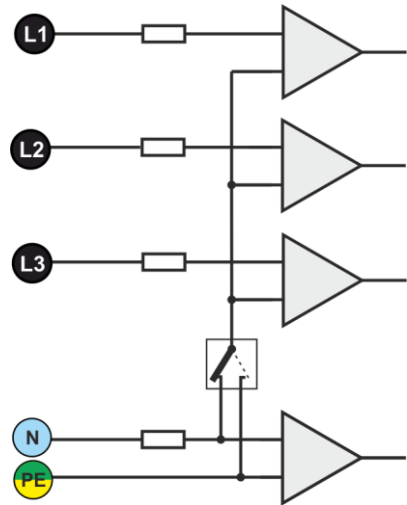

Fig. 67. Voltage input terminals

Ensuring the least possible phase shift between the voltage and current components is very important for obtaining small power measurement errors. It can be proven that approximate power measurement error can be described with the following relationship<sup>1</sup>:

$$\text{Power measurement error} \approx \text{phase error (in radians)} \times \tan(\varphi) \times 100 \%$$

where  $\tan(\varphi)$  is the tangent of the angle between the fundamental voltage and current components. From the formula, it can be concluded that the measurement errors are increasing as the displacement power factor is decreasing; for example, at the phase error of only  $0.1^\circ$  and  $\cos\varphi = 0.5$ , the error is 0.3%. Anyway, for the power measurements to be accurate, the phase coincidence of voltage and current circuits must be the highest possible.

### 3.4 Signal sampling

The signal is sampled simultaneously in all eight channels at the frequency synchronized with the frequency of power supply voltage in the reference channel. This frequency equals 10.24 kHz for the 50 Hz and 60 Hz mains systems.

Each period includes then about 205 samples for 50 Hz systems, and about 170 samples for 60 Hz systems. A 16-bit analog-to-digital converter has been used which ensures 64-fold oversampling.

3-decibel channels attenuation has been specified for frequency of about 12 kHz, and the amplitude error for the 2.4 kHz maximum usable frequency (i.e. the frequency of 40th harmonics in the 60 Hz system) is about 0.3 dB. The phase shift for this frequency is below  $15^\circ$ . Attenuation in the stop band is above 75 dB.

Please note that for correct measurements of phase shift between the voltage harmonics in relation to current harmonics and power of these harmonics, the important factor is not absolute phase shift in relation to the basic frequency, but the phase coincidence of voltage and current circuits. The highest phase difference error for  $f = 2.4$  kHz is maximum  $15^\circ$ . Such error is decreasing with the decreasing frequency. Also an additional error caused by used probes are transducers must be considered when estimating the measurement errors for harmonics power measurements.

### 3.5 PLL synchronization

The sampling frequency synchronization has been implemented by hardware. After passing through the input circuits, the voltage signal is sent to a band-pass filter which is to reduce the harmonics level and pass only the voltage fundamental component. Then, the signal is sent to the phase locked loop circuits as a reference signal. The PLL system generates the frequency which is a multiple of the reference frequency necessary for clocking of the analog-to-digital converter.

The input voltage range for which the PLL system will work correctly is quite another matter. The 61000-4-7 standard does not give here any concrete indications or requirements. The PQM-707 PLL circuit needs L1-N voltage above 15 V for proper operation.

### 3.6 Frequency measurement

The signal for measurement of 10-second frequency values is taken from the L1 voltage channel. It is the same signal which is used for synchronization of the PLL. The L1 signal is sent to the 2<sup>nd</sup> order band pass filter which passband has been set to 40...70 Hz. This filter is to reduce the level of harmonic components. Then, a square signal is formed from such filtered waveform. The signal periods number and their duration is counted during the 10-second measuring cycle. 10-second time intervals are determined by the real time clock (every full multiple of 10-second time). The frequency is calculated as a ratio of counted periods to their duration.

---

<sup>1</sup> "Current sensing for energy metering", William Koon, Analog Devices, Inc.

### 3.7 Event detection

The PQM-707 analyzer gives a lot of event detection options in the tested mains system. An event is the situation when the parameter value exceeds the user-defined threshold. The fact of event occurrence is recorded on the memory card as an entry which includes:

- parameter type,
- channel in which the event occurred,
- times of event beginning and end,
- user-defined threshold value,
- parameter extreme value measure during the event,
- parameter average value measure during the event.

Depending on the parameter type, you can set one, two or three thresholds which will be checked by the analyzer. The table below lists all parameters for which the events can be detected, including specification of threshold types.

**Tab. 8. Event threshold types for individual parameters**

Parameter	Parameter	Interruption	Dip	Swell	Minimum	Maximum
U	RMS voltage	•	•	•		
$U_{DC}$	DC voltage					• <sup>(1)</sup>
I	RMS current				•	•
$I_{DC}$	DC current					• <sup>(1)(2)</sup>

<sup>(1)</sup> only in DC and DC+M system types.

<sup>(2)</sup> only by using C-5A probes.

Some parameters can take positive and negative values. Examples are DC voltage and current. As the event detection threshold can only be positive, in order to ensure correct detection for above-mentioned parameters, the analyzer compares with the threshold their absolute values.

**Example**

*Event threshold for DC voltage has been set at 100 V. If the measured DC voltage goes below -100V, there will be detected an event of exceeding DC voltage value.*

Two parameter types: RMS voltage and RMS current can generate events for which the user can also have the waveforms record.

The analyzer records the waveforms of active channels (voltage and current) at the event start and end. In both cases, six periods are recorded: two before the start (end) of the event and four after start (end) of the event. The waveforms are recorded in an 8-bit format with 10.24 kHz sampling frequency.

The event information is recorded at its end. In some cases it may happen that event is active when the recording is stopped (i.e. the voltage dip continues). Information about such event is also recorded, but with the following changes:

- no event end time,
- extreme value is only for the period until the stop of recording,
- average value is not given,
- only the beginning waveform is available for RMS voltage or current related events.

In order to eliminate repeated event detection when the parameter value oscillates around the threshold value, the analyzer has a functionality of user-defined event detection hysteresis. It is defined in percent in the following manner:

- for RMS voltage events, it is the percent of the nominal voltage range (for example 2% of 230 V, that is 4.6 V),
- for RMS current events, it is the percent of the nominal current range (for example for C-4 probes and absence of transducers, the 2% hysteresis equals  $0.02 \times 1000 \text{ A} = 20 \text{ A}$ ),
- for remaining parameters, the hysteresis is specified as a percent of maximum threshold (for example, if the maximum threshold for DC voltage has been set to 100V, the hysteresis will be  $0.02 \times 100\text{V} = 2\text{V}$ ).

### 3.8 Methods of parameter's averaging

Method of averaging parameter	
Parameter	Averaging method
RMS Voltage	RMS
DC voltage, DC current	arithmetic average
Frequency	arithmetic average
Crest Factor U, I	arithmetic average
Symmetrical components U, I	RMS
Unbalance factor U, I	calculated from average values of symmetrical components
RMS Current	RMS
Active, Reactive, Apparent and Distortion Power	arithmetic average
Power Factor	calculated from the averaged power values
$\cos\phi$	arithmetic average
$\tan\phi$	calculated from the averaged power values
THD-F U, I	calculated as the ratio of the average RMS value of the higher harmonics to the average RMS value of the fundamental component (for THD-F), or the ratio of the average of RMS value of higher harmonics to the average value of RMS value (for THD-R)
Harmonic amplitudes U, I	RMS

#### Note:

RMS average value is calculated according to the formula:

$$RMS = \sqrt{\frac{1}{N} \sum_{i=1}^N X_i^2}$$

The arithmetic average (AVG) is calculated according to the formula:

$$AVG = \frac{1}{N} \sum_{i=1}^N X_i$$

where:

- $X_i$  is subsequent parameter value to be averaged,
- N is the number of values to be averaged.

## 4 Calculation formulas

### 4.1 Single-phase network

Single-phase network			
Parameter			Method of calculation
Name	Designation	Unit	
Voltage (True RMS)	$U_A$	V	$U_A = \sqrt{\frac{1}{M} \sum_{i=1}^M U_i^2}$ where $U_i$ is a subsequent sample of voltage $U_{A-N}$ $M = 2048$ for 50Hz and 60 Hz
Voltage DC component	$U_{ADC}$	V	$U_{ADC} = \frac{1}{M} \sum_{i=1}^M U_i$ where $U_i$ is a subsequent sample of voltage $U_{A-N}$ $M = 2048$ for 50Hz and 60 Hz
Frequency	$F$	Hz	number of full voltage periods $U_{A-N}$ counted during 10-sec period (clock time) divided by the total duration of full periods
Current (True RMS)	$I_A$	A	$I_A = \sqrt{\frac{1}{M} \sum_{i=1}^M I_i^2}$ where $I_i$ is subsequent sample of current $I_A$ $M = 2048$ for 50Hz and 60 Hz
Current constant component	$I_{ADC}$	A	$I_{ADC} = \frac{1}{M} \sum_{i=1}^M I_i$ where $I_i$ is a subsequent sample of current $I_A$ $M = 2048$ for 50Hz and 60 Hz
Active power	$P$	W	$P = \frac{1}{M} \sum_{i=1}^M U_i I_i$ where $U_i$ is a subsequent sample of voltage $U_{A-N}$ $I_i$ is a subsequent sample of current $I_A$ $M = 2048$ for 50Hz and 60 Hz
Budeanu reactive power	$Q_B$	var	$Q_B = \sum_{h=1}^{40} U_h I_h \sin \varphi_h$ where $U_h$ is $h$ -th harmonic of voltage $U_{A-N}$ $I_h$ is $h$ -th harmonic of current $I_A$ $\varphi_h$ is $h$ -th angle between harmonic $U_h$ and $I_h$
Reactive power of fundamental component	$Q_1$	var	$Q_1 = U_1 I_1 \sin \varphi_1$ where $U_1$ is fundamental component of voltage $U_{A-N}$ $I_1$ is fundamental component of current $I_A$ $\varphi_1$ is angle between fundamental components $U_1$ and $I_1$
Apparent power	$S$	VA	$S = U_{ARMS} I_{ARMS}$
Apparent distortion power	$S_N$	VA	$S_N = \sqrt{S^2 - (U_1 I_1)^2}$
Budeanu distortion power	$D_B$	var	$D_B = \sqrt{S^2 - P^2 - Q_B^2}$
Power Factor	$PF$	-	$PF = \frac{P}{S}$ If $PF < 0$ , then the load is of a generator type If $PF > 0$ , then the load is of a receiver type
Displacement power factor	$\cos \varphi$ $DPF$	-	$\cos \varphi = DPF = \cos(\varphi_{U_1} - \varphi_{I_1})$ where $\varphi_{U_1}$ is an absolute angle of the fundamental component of voltage $U_{A-N}$ $\varphi_{I_1}$ is an absolute angle of the fundamental component of current $I_A$

#### 4 Calculation formulas

Tangent $\varphi$	$\tan \varphi$	-	$\tan \varphi = \frac{Q}{P}$ where: $Q = Q_B$ when Budeanu method was chosen, $Q = Q_I$ when IEEE 1459 method was chosen,
Harmonic components of voltage and current	$U_{hx}$ $I_{hx}$	V A	method of harmonic subgroups according to IEC 61000-4-7 $x$ (harmonic) = 1..50
Total Harmonic Distortion for voltage, referred to the fundamental component	$THDU_F$	-	$THDU_F = \frac{\sqrt{\sum_{h=2}^{40} U_h^2}}{U_1} \times 100\%$ where $U_h$ is $h$ -th harmonic of voltage $U_{A-N}$ $U_1$ is fundamental component of voltage $U_{A-N}$
Total Harmonic Distortion for voltage, referred to RMS	$THDU_R$	-	$THDU_R = \frac{\sqrt{\sum_{h=2}^{40} U_h^2}}{U_{ARMS}} \times 100\%$ where $U_h$ is $h$ -th harmonic of voltage $U_{A-N}$
Total Harmonic Distortion for current, referred to the fundamental component	$THDI_F$	-	$THDI_F = \frac{\sqrt{\sum_{h=2}^{40} I_h^2}}{I_1} \times 100\%$ where $I_h$ is $h$ -th harmonic of current $I_A$ $I_1$ is fundamental component of current $I_A$
Total Harmonic Distortion for current, referred to RMS	$THDI_R$	-	$THDI_R = \frac{\sqrt{\sum_{h=2}^{40} I_h^2}}{I_{ARMS}} \times 100\%$ where $I_h$ is $h$ -th harmonic of current $I_A$
Voltage crest factor	$CFU$	-	$CFU = \frac{\max U_i }{U_{ARMS}}$ max $ U_i $ Where the operator expresses the highest absolute value of voltage $U_{A-N}$ samples $i = 2048$ for 50 Hz and 60 Hz
Current crest factor	$CFI$	-	$CFI = \frac{\max I_i }{I_{ARMS}}$ max $ I_i $ Where the operator expresses the highest absolute value of current $I_A$ samples $i = 2048$ for 50 Hz and 60 Hz
Short-term flicker	$P_{st}$	-	calculated according to IEC 61000-4-15
Long-term flicker	$P_{lt}$	-	$P_{LT} = \sqrt[3]{\frac{\sum_{i=1}^N P_{STi}^3}{N}}$ where $P_{STi}$ is subsequent $i$ -th indicator of short-term flicker
Active energy (consumed and supplied)	$E_{p+}$ $E_{p-}$	Wh	$E_{p+} = \sum_{i=1}^m P_+(i)T(i)$ $P_+(i) = \begin{cases} P(i) & \text{dla } P(i) > 0 \\ 0 & \text{dla } P(i) \leq 0 \end{cases}$ $E_{p-} = \sum_{i=1}^m P_-(i)T(i)$ $P_-(i) = \begin{cases}  P(i)  & \text{dla } P(i) < 0 \\ 0 & \text{dla } P(i) \geq 0 \end{cases}$ where: $i$ is subsequent number of the 10/12-period measurement window $P(i)$ represents active power $P$ calculated in $i$ -th measuring window $T(i)$ represents duration of $i$ -th measuring window (in hours)

<p>Budeanu reactive energy (consumed and supplied)</p>	$\begin{matrix} E_{QB+} \\ E_{QB-} \end{matrix}$	<p>varh</p>	$E_{QB+} = \sum_{i=1}^m Q_{B+}(i)T(i)$ $Q_{B+}(i) = \begin{cases} Q_B(i) & \text{dla } Q_B(i) > 0 \\ 0 & \text{dla } Q_B(i) \leq 0 \end{cases}$ $E_{QB-} = \sum_{i=1}^m Q_{B-}(i)T(i)$ $Q_{B-}(i) = \begin{cases}  Q_B(i)  & \text{dla } Q_B(i) < 0 \\ 0 & \text{dla } Q_B(i) \geq 0 \end{cases}$ <p>where:  <i>i</i> is subsequent number of the 10/12-period measurement window  <i>Q<sub>B</sub>(i)</i> represents Budeanu active power <i>Q<sub>B</sub></i> calculated in <i>i</i>-th measuring window  <i>T(i)</i> represents duration of <i>i</i>-th measuring window (in hours)</p>
<p>Reactive energy of fundamental component (consumed and supplied)</p>	$\begin{matrix} E_{Q1+} \\ E_{Q1-} \end{matrix}$	<p>varh</p>	$E_{Q1+} = \sum_{i=1}^m Q_{1+}(i)T(i)$ $Q_{1+}(i) = \begin{cases} Q_1(i) & \text{dla } Q_1(i) > 0 \\ 0 & \text{dla } Q_1(i) \leq 0 \end{cases}$ $E_{Q1-} = \sum_{i=1}^m Q_{1-}(i)T(i)$ $Q_{1-}(i) = \begin{cases}  Q_1(i)  & \text{dla } Q_1(i) < 0 \\ 0 & \text{dla } Q_1(i) \geq 0 \end{cases}$ <p>where:  <i>i</i> is subsequent number of the 10/12-period measurement window  <i>Q<sub>1</sub>(i)</i> represents reactive power of fundamental component <i>Q<sub>1</sub></i> calculated in <i>i</i>-th measuring window  <i>T(i)</i> represents duration of <i>i</i>-th measuring window (in hours)</p>
<p>Apparent energy</p>	$E_S$	<p>VAh</p>	$E_S = \sum_{i=1}^m S(i)T(i)$ <p>where:  <i>i</i> is subsequent number of the 10/12-period measurement window  <i>S(i)</i> represents apparent power <i>S</i> calculated in <i>i</i>-th measuring window  <i>T(i)</i> represents duration of <i>i</i>-th measuring window (in hours)</p>

## 4.2 Split-phase network

<b>Split-phase network</b>			
(parameters not mentioned are calculated as for single-phase)			
Parameter			Method of calculation
Name	Designation	Unit	
Total active power	$P_{tot}$	W	$P_{tot} = P_A + P_B$
Total Budeanu reactive power	$Q_{Btot}$	var	$Q_{Btot} = Q_{BA} + Q_{BB}$
Total reactive power of fundamental component	$Q_{1tot}$	var	$Q_{1tot} = Q_{1A} + Q_{1B}$
Total apparent power	$S_{tot}$	VA	$S_{tot} = S_A + S_B$
Total apparent distortion power	$S_{Ntot}$	VA	$S_{Ntot} = S_{NA} + S_{NB}$
Total Budeanu distortion power	$D_{Btot}$	var	$D_{Btot} = D_{BA} + D_{BB}$
Total Power Factor	$PF_{tot}$	-	$PF_{tot} = \frac{P_{tot}}{S_{tot}}$
Total displacement power factor	$\cos\varphi_{tot}$ $DPF_{tot}$	-	$\cos\varphi_{tot} = DPF_{tot} = \frac{1}{2}(\cos\varphi_A + \cos\varphi_B)$
Total tangent $\varphi$	$\tan\varphi_{tot}$	-	$\tan\varphi_{tot} = \frac{Q_{tot}}{P_{tot}}$ where: $Q_{tot} = Q_{Btot}$ , when Budeanu method was chosen, $Q_{tot} = Q_{1tot}$ , when IEEE 1459 method was chosen,
Total active energy (consumed and supplied)	$E_{P+tot}$ $E_{P-tot}$	Wh	$E_{P+tot} = \sum_{i=1}^m P_{tot+}(i)T(i)$ $P_{tot+}(i) = \begin{cases} P_{tot}(i) & \text{dla } P_{tot}(i) > 0 \\ 0 & \text{dla } P_{tot}(i) \leq 0 \end{cases}$ $E_{P-tot} = \sum_{i=1}^m P_{tot-}(i)T(i)$ $P_{tot-}(i) = \begin{cases}  P_{tot}(i)  & \text{dla } P_{tot}(i) < 0 \\ 0 & \text{dla } P_{tot}(i) \geq 0 \end{cases}$ <p>where: <math>i</math> is subsequent number of the 10/12-period measurement window <math>P_{tot}(i)</math> represents total active power <math>P_{tot}</math> calculated in <math>i</math>-th measuring window <math>T(i)</math> represents duration of <math>i</math>-th measuring window (in hours)</p>
Total Budeanu reactive energy (consumed and supplied)	$E_{QB+tot}$ $E_{QB-tot}$	varh	$E_{QB+tot} = \sum_{i=1}^m Q_{Btot+}(i)T(i)$ $Q_{Btot+}(i) = \begin{cases} Q_{Btot}(i) & \text{dla } Q_{Btot}(i) > 0 \\ 0 & \text{dla } Q_{Btot}(i) \leq 0 \end{cases}$ $E_{QB-tot} = \sum_{i=1}^m Q_{Btot-}(i)T(i)$ $Q_{Btot-}(i) = \begin{cases}  Q_{Btot}(i)  & \text{dla } Q_{Btot}(i) < 0 \\ 0 & \text{dla } Q_{Btot}(i) \geq 0 \end{cases}$ <p>where: <math>i</math> is subsequent number of the 10/12-period measurement window <math>Q_{Btot}(i)</math> represents total reactive power <math>Q_{Btot}</math> calculated in <math>i</math>-th measuring window <math>T(i)</math> represents duration of <math>i</math>-th measuring window (in hours)</p>

<p>Total reactive energy of fundamental component (consumed and supplied)</p>	$E_{Q_{1+tot}}$ $E_{Q_{1-tot}}$	<p>varh</p>	$E_{Q_{1+tot}} = \sum_{i=1}^m Q_{1tot+}(i)T(i)$ $Q_{1tot+}(i) = \begin{cases} Q_{1tot+}(i) \text{ dla } Q_{1tot}(i) > 0 \\ 0 \text{ dla } Q_{1tot}(i) \leq 0 \end{cases}$ $E_{Q_{1-tot}} = \sum_{i=1}^m Q_{1tot-}(i)T(i)$ $Q_{1tot-}(i) = \begin{cases}  Q_{1tot-}(i)  \text{ dla } Q_{1tot}(i) < 0 \\ 0 \text{ dla } Q_{1tot}(i) \geq 0 \end{cases}$ <p>where:  <i>i</i> is subsequent number of the 10/12-period measurement window  <math>Q_{1tot}(i)</math> represents total reactive power <math>Q_{1tot}</math> calculated in <i>i</i>-th measuring window  <math>T(i)</math> represents duration of <i>i</i>-th measuring window (in hours)</p>
<p>Total apparent energy</p>	$E_{S_{tot}}$	<p>VAh</p>	$E_{S_{tot}} = \sum_{i=1}^m S_{tot}(i)T(i)$ <p>where:  <i>i</i> is subsequent number of the 10/12-period measurement window  <math>S_{tot}(i)</math> represents total apparent power <math>S_{tot}</math> calculated in <i>i</i>-th measuring window  <math>T(i)</math> represents duration of <i>i</i>-th measuring window (in hours)</p>

### 4.3 3-phase 4-wire network

3-phase 4-wire network			
(parameters not mentioned are calculated as for single-phase)			
Parameter			Method of calculation
Name	Designation	Unit	
Total active power	$P_{tot}$	W	$P_{tot} = P_A + P_B + P_C$
Total Budeanu reactive power	$Q_{Btot}$	var	$Q_{Btot} = Q_{BA} + Q_{BB} + Q_{BC}$
Total reactive power acc. to IEEE 1459	$Q_1^+$	var	$Q_1^+ = 3U_1^+ I_1^+ \sin \varphi_1^+$ <p>where:  <math>U_{1+}</math> is the voltage positive sequence component (of the fundamental component)  <math>I_{1+}</math> is the current positive sequence component (of the fundamental component)  <math>\varphi_{1+}</math> is the angle between components <math>U_{1+}</math> and <math>I_{1+}</math></p>
Effective apparent power	$S_e$	VA	$S_e = 3U_e I_e$ <p>where:</p> $U_e = \sqrt{\frac{3(U_A^2 + U_B^2 + U_C^2) + U_{AB}^2 + U_{BC}^2 + U_{CA}^2}{18}}$ $I_e = \sqrt{\frac{I_A^2 + I_B^2 + I_C^2 + I_N^2}{3}}$
Effective apparent distortion power	$S_{eN}$	VA	$S_{eN} = \sqrt{S_e^2 + S_{e1}^2}$

			<p>where:  <math>S_{e1} = 3U_{e1}I_{e1}</math></p> $U_{e1} = \sqrt{\frac{3(U_{A1}^2 + U_{B1}^2 + U_{C1}^2) + U_{AB1}^2 + U_{BC1}^2 + U_{CA1}^2}{18}}$ $I_{e1} = \sqrt{\frac{I_{A1}^2 + I_{B1}^2 + I_{C1}^2 + I_{N1}^2}{3}}$
Total Budeanu distortion power	$D_{Btot}$	var	$D_{Btot} = D_{BA} + D_{BB} + D_{BC}$
Total Power Factor	$PF_{tot}$	-	$PF_{tot} = \frac{P_{tot}}{S_e}$
Total displacement power factor	$\cos\varphi_{tot}$ $DPF_{tot}$	-	$\cos \varphi_{tot} = DPF_{tot} = \frac{1}{3}(\cos \varphi_A + \cos \varphi_B + \cos \varphi_C)$
Total tangent $\varphi$	$\tan\varphi_{tot}$	-	$\tan\varphi_{tot} = \frac{Q_{tot}}{P_{tot}}$ <p>where: <math>Q_{tot} = Q_{Btot}</math>, when Budeanu method was chosen,  <math>Q_{tot} = Q_{1tot}</math>, when IEEE 1459 method was chosen,</p>
Total active energy (consumed and supplied)	$E_{P+tot}$ $E_{P-tot}$	Wh	formula same as in split-phase system
Total Budeanu reactive energy (consumed and supplied)	$E_{QB+tot}$ $E_{QB-tot}$	varh	formula same as in split-phase system
Total reactive energy of fundamental component (consumed and supplied)	$E_{Q1+tot}$ $E_{Q1-tot}$	varh	formula same as in split-phase system
Total apparent energy	$E_{Stot}$	VAh	$E_{Stot} = \sum_{i=1}^m S_e(i)T(i)$ <p>where:  <math>i</math> is subsequent number of the 10/12-period measurement window  <math>S_e(i)</math> represents the effective apparent power <math>S_e</math>, calculated in <math>i</math>-th measuring window  <math>T(i)</math> represents duration of <math>i</math>-th measuring window (in hours)</p>
RMS value of zero voltage sequence	$U_0$	V	$\underline{U}_0 = \frac{1}{3}(\underline{U}_{A1} + \underline{U}_{B1} + \underline{U}_{C1})$ $U_0 = \text{mag}(\underline{U}_0)$ <p>where <math>\underline{U}_{A1}</math>, <math>\underline{U}_{B1}</math>, <math>\underline{U}_{C1}</math> are vectors of fundamental components of phase voltages <math>U_A</math>, <math>U_B</math>, <math>U_C</math>  Operator <math>\text{mag}()</math> indicates vector module</p>
RMS value of positive voltage sequence	$U_1$	V	$\underline{U}_1 = \frac{1}{3}(\underline{U}_{A1} + a\underline{U}_{B1} + a^2\underline{U}_{C1})$ $U_1 = \text{mag}(\underline{U}_1)$ <p>where <math>\underline{U}_{A1}</math>, <math>\underline{U}_{B1}</math>, <math>\underline{U}_{C1}</math> are vectors of fundamental components of phase voltages <math>U_A</math>, <math>U_B</math>, <math>U_C</math>  Operator <math>\text{mag}()</math> indicates vector module</p> $a = 1e^{j120^\circ} = -\frac{1}{2} + \frac{\sqrt{3}}{2}j$ $a^2 = 1e^{j240^\circ} = -\frac{1}{2} - \frac{\sqrt{3}}{2}j$

RMS value of negative voltage sequence	$U_2$	V	$U_2 = \frac{1}{3}(U_{A1} + a^2 U_{B1} + a U_{C1})$ $U_2 = \text{mag}(U_2)$ <p>where <math>\underline{U}_{A1}</math>, <math>\underline{U}_{B1}</math>, <math>\underline{U}_{C1}</math> are vectors of fundamental components of phase voltages <math>U_A</math>, <math>U_B</math>, <math>U_C</math> Operator <math>\text{mag}()</math> indicates vector module</p> $a = 1e^{j120^\circ} = -\frac{1}{2} + \frac{\sqrt{3}}{2}j$ $a^2 = 1e^{j240^\circ} = -\frac{1}{2} - \frac{\sqrt{3}}{2}j$
Voltage unbalance factor for zero component	$u_0$	%	$u_0 = \frac{U_0}{U_1} \cdot 100\%$
Voltage unbalance factor for negative sequence	$u_2$	%	$u_2 = \frac{U_2}{U_1} \cdot 100\%$
Current zero sequence	$I_0$	A	$I_0 = \frac{1}{3}(I_{A1} + I_{B1} + I_{C1})$ $I_0 = \text{mag}(I_0)$ <p>where <math>\underline{I}_{A1}</math>, <math>\underline{I}_{B1}</math>, <math>\underline{I}_{C1}</math> are vectors of fundamental components for phase currents <math>I_A</math>, <math>I_B</math>, <math>I_C</math> Operator <math>\text{mag}()</math> indicates vector module</p>
RMS value of positive current sequence	$I_1$	A	$I_1 = \frac{1}{3}(I_{A1} + a I_{B1} + a^2 I_{C1})$ $I_1 = \text{mag}(I_1)$ <p>where <math>\underline{I}_{A1}</math>, <math>\underline{I}_{B1}</math>, <math>\underline{I}_{C1}</math> are vectors of fundamental current components <math>I_A</math>, <math>I_B</math>, <math>I_C</math> Operator <math>\text{mag}()</math> indicates vector module</p>
RMS value of negative current sequence	$I_2$	A	$I_2 = \frac{1}{3}(I_{A1} + a^2 I_{B1} + a I_{C1})$ $I_2 = \text{mag}(I_2)$ <p>where <math>\underline{I}_{A1}</math>, <math>\underline{I}_{B1}</math>, <math>\underline{I}_{C1}</math> are vectors of fundamental components for phase voltages <math>I_A</math>, <math>I_B</math>, <math>I_C</math> Operator <math>\text{mag}()</math> indicates vector module</p>
Current unbalance factor for zero sequence	$i_0$	%	$i_0 = \frac{I_0}{I_1} \cdot 100\%$
Current unbalance factor for negative sequence	$i_2$	%	$i_2 = \frac{I_2}{I_1} \cdot 100\%$

#### 4.4 3-phase 4-wire (no U L2) / 2 1/2 - element network

3-phase 4-wire (no U L2) / 2 1/2 - element network			
All parameters are calculated as in 3-phase 4-wire network except $U_B$ voltage			
Parameter			Method of calculation
Name	Designation	Unit	
$U_B$ phase voltage	$U_B$	V	$U_B = -(U_A + U_C)$

## 4.5 3-phase 3-wire networks

<b>3-phase 3-wire network</b> <b>3-phase open delta network</b> <b>2-element network</b>			
(Parameters: RMS voltage and current, DC components of voltage and current, THD, flicker are calculated as for 1-phase circuits; instead of the phase voltages, phase-to-phase voltages are used. Symmetrical components and unbalance factors are calculated as in 3-phase 4-wire systems.)			
Parameter			Method of calculation
Name	Designation	Unit	
Phase-to-phase voltage $U_{CA}$	$U_{CA}$	V	$U_{CA} = -(U_{AB} + U_{BC})$
Current $I_2$ (Aron measuring circuits)	$I_2$	A	$I_2 = -(I_1 + I_3)$
Total active power	$P_{tot}$	W	$P_{tot} = \frac{1}{M} \left( \sum_{i=1}^M U_{iAC} I_{iA} + \sum_{i=1}^M U_{iBC} I_{iB} \right)$ where: $U_{iAC}$ is a subsequent sample of voltage $U_{A-C}$ $U_{iBC}$ is a subsequent sample of voltage $U_{B-C}$ $I_{iA}$ is a subsequent sample of current $I_A$ $I_{iB}$ is a subsequent sample of current $I_B$ $M = 2048$ for 50Hz and 60Hz
Total apparent power	$S_e$	VA	$S_e = 3U_e I_e$ where: $U_e = \sqrt{\frac{U_{AB}^2 + U_{BC}^2 + U_{CA}^2}{9}}$ $I_e = \sqrt{\frac{I_A^2 + I_B^2 + I_C^2}{3}}$
Total reactive power (Budeanu and IEEE 1459)	$Q_{Btot}$	var	$Q = N = \sqrt{S_e^2 - P^2}$
Total Budeanu distortion power	$D_{Btot}$	var	$D_{Btot} = 0$
Effective apparent distortion power	$S_{eN}$	VA	$S_{eN} = \sqrt{S_e^2 + S_{e1}^2}$ where: $S_{e1} = 3U_{e1} I_{e1}$ $U_{e1} = \sqrt{\frac{U_{AB1}^2 + U_{BC1}^2 + U_{CA1}^2}{9}}$ $I_{e1} = \sqrt{\frac{I_{A1}^2 + I_{B1}^2 + I_{C1}^2}{3}}$
Total Power Factor	$PF_{tot}$	-	$PF_{tot} = \frac{P_{tot}}{S_e}$
Active energy (consumed and supplied)	$E_{P+tot}$ $E_{P-tot}$	Wh	formula same as in split-phase system
Total apparent energy	$E_{Stot}$	VAh	$E_{Stot} = \sum_{i=1}^m S_e(i)T(i)$ where: $i$ is subsequent number of the 10/12-period measurement window $S_e(i)$ represents the total apparent power $S_e$ calculated in $i$ -th measuring window $T(i)$ represents duration of $i$ -th measuring window (in hours)

## Technical specification

- Technical specification is subject to change without prior notice. The latest revisions of technical documentation are available at [www.sonel.com](http://www.sonel.com).
- Basic uncertainty is uncertainty of a measuring instrument in reference conditions given in Table 10.
- Given uncertainty values refer to the PQM-707 analyzer without additional transducers and probes.
- Abbreviations:
  - m.v. – measured value,
  - $U_{nom}$  – nominal voltage,
  - $I_{nom}$  – nominal current range (probe),
  - RMS – root mean square value,
  - n – harmonic order,
  - s.d. – significant digits (or significant figures) – in reference to resolution of measurement result, the value is recorded with the given number of significant digits, e.g. resolution for 230 V with 4 s.d. will be 0.1 V (notation 230.0 V); resolution for 5 A with 4 s.d. will be 0.001 A (notation 5.000 A),
  - $\delta_{ph}$  – additional uncertainty caused by the error of phase measurement between the voltage and current harmonics.

### 5.1 Inputs

Voltage inputs	
Number of inputs	5 (L1/A, L2/B, L3/C, N, PE - 4 measuring channels) not galvanically isolated between each other
Maximum input voltage	L1/A, L2/B, L3/C, N: $760 V_{RMS}$ 40...70 Hz or DC referred to protective earth terminal (PE)
Measurement category	CAT IV 600 V CAT III 760 V
Peak input voltage (no ADC saturation)	$\pm 1150$ V (L-N, L-PE)
Range of measured DC voltages	$\pm 1150$ V
Analog passband (-3dB)	12 kHz
Transducers	defined by user
Impedance of measurement inputs	13.8 M $\Omega$ (L-L, L-N) 6.9 M $\Omega$ (L-PE)
CMRR	>70 dB (50 Hz)

Current inputs	
Number of inputs	4 (L1, L2, L3, N) not isolated galvanically between each other
Peak input voltage	5 V referred to protective earth terminal (PE)
Nominal input voltage (CT probes)	1 $V_{RMS}$
Peak input voltage (CT probes, no ADC saturation)	$\pm 3.6$ V
Nominal input voltage (flexible clamps)	0.125 $V_{RMS}$
Peak input voltage (flexible clamps; without ADC overflow)	$\pm 0.45$ V
Maximum current probes input voltage referred to earth	5 $V_{RMS}$
Analog passband (-3dB)	12 kHz
Input impedance	CT probes: 100 k $\Omega$ Flexible probes: 12.4 k $\Omega$
Measurement range (without transducers)	Flexible probes F-1(A)/F-2(A)/F-3(A): 1..3000 A ( $\pm 10$ kA peak, 50 Hz) Flexible probes F-2AHD/F-3AHD: 1..3000 A ( $\pm 10$ kA peak, 50 Hz) Flexible probes F-1A6/F-2A6/F-3A6: 1..6000 A ( $\pm 20$ kA peak, 50 Hz) Flexible probes F-1A1/F-2A1/F-3A1: 1..1500 A ( $\pm 5$ kA peak, 50 Hz) CT probes C-4(A): 1..1000 A CT probes C-5A: 1..1400 A CT probes C-6(A): 0.01..12 A CT probes C-7(A): 0..100 A
Transformers	defined by user
CMRR	60 dB (50 Hz)

## Sampling and real time clock

Sampling and real time clock	
A/D converter	16-bit
Sampling rate	10.24 kHz for 50 Hz and 60 Hz Simultaneous sampling in all channels
Samples per period	204.8 for 50 Hz; 170.67 for 60 Hz
PLL synchronization	40..70Hz
Reference channel for PLL	L1-N, L1-L2 (depending on mains type)
Real-time clock	±3.5 ppm max (approx. ± 9 sec./month, ± 0.3 sec./day ) in the temperature range of -10°C...+50°C

## 5.3 Measured parameters – accuracy, resolution and ranges

### 5.3.1 Reference conditions

Tab. 9. Reference conditions.

Reference conditions	
Ambient temperature	23°C ±2°C
Relative humidity	40...60%
External supply voltage	12V ±1%
Input voltage	U <sub>nom</sub> ±1%
Flicker	P <sub>ST</sub> < 0.1
Voltage unbalance	≤ 0.1% for unbalance factor of negative sequence (applies only to 3-phase systems)
External continuous magnetic field	≤ 40 A/m DC ≤ 3 A/m AC for 50/60 Hz frequency
DC component of voltage and current	none
Waveforms	sinusoidal
Frequency	50 ±0.5 Hz lub 60 ±0.5 Hz

### 5.3.2 Measurement uncertainty within rated temperature range

The basic uncertainty given in technical data applies to reference conditions only (Tab. 9). Outside of this range an additional multiplier has to be used, as shown in Fig. 68. The multiplier (M) is 2.0 in the ambient temperature range 0°C...+45°C. Over +45°C up to +55°C it rises in linear manner up to 3.0. Below 0°C down to -25°C it rises in linear manner to 3.0.

For example: the basic uncertainty for RMS voltage measurement is  $\pm 0.5\% U_{nom}$ .

- At the -10°C measurement uncertainty is  $\pm 2.4 \times 0.5\% U_{nom}$  that is  $\pm 1.2\% U_{nom}$  (multiplier 2.4),
- At the 0°C measurement uncertainty is  $\pm 1\% U_{nom}$  (multiplier 2.0),
- At the +45°C measurement uncertainty is  $\pm 1\% U_{nom}$  (multiplier 2.0),
- At the +50°C measurement uncertainty is  $\pm 1.25\% U_{nom}$  (multiplier 2.5).

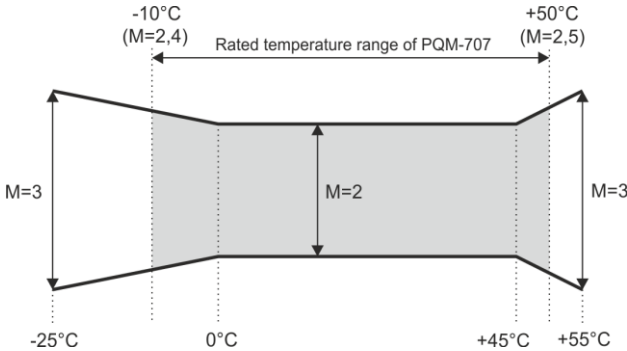

**Fig. 68. Basic uncertainty multiplier M as a function of ambient temperature (does not apply to the reference conditions).**

### 5.3.3 Voltage

Voltage	Ranges and conditions	Resolution	Basic uncertainty
$U_{RMS}$ (AC+DC)	$20\% U_{nom} \leq U_{RMS} \leq 120\% U_{nom}$ for $U_{nom} \geq 100\text{ V}$	4 s.d.	$\pm 0.5\% U_{nom}$
Crest Factor	1..10 (1..1.65 for 690 V voltage) for $U_{RMS} \geq 10\% U_{nom}$	0.01	$\pm 5\%$

### 5.3.4 Current

Current	Ranges and conditions	Resolution	Basic uncertainty
$I_{RMS}$ (AC+DC)	<b>Input path without clamps</b>		
	CT line: 0..1 V ( $\pm 3.6$ V max)  flexible probes line: 0..125 mV ( $\pm 450$ mV max)	4 s.d.	$\pm 0.2\% I_{nom}$
	<b>Flexible probes F-1(A)/F-2(A)/F-3(A)</b>		
	0..3000 A ( $\pm 10$ kA)	4 s.d.	<b>Additional uncertainty</b> See the probes user manual
	<b>Flexible probes F-2AHD/F-3AHD</b>		
	0..3000 A ( $\pm 10$ kA max)	4 s.d.	<b>Additional uncertainty</b> See the probes user manual
	<b>Flexible probes F-1A6/F-2A6/F-3A6</b>		
	0..6000 A ( $\pm 20$ kA max)	4 s.d.	<b>Additional uncertainty</b> See the probes user manual
	<b>Flexible probes F-1A1/F-2A1/F-3A1</b>		
	0..1500 A ( $\pm 5$ kA max)	4 s.d.	<b>Additional uncertainty</b> See the probes user manual
	<b>CT probes C-4(A)</b>		
	0..1000 A	4 s.d.	<b>Additional uncertainty</b> See the probes user manual
	<b>CT probes C-5A</b>		
0..1400 A	4 s.d.	<b>Additional uncertainty</b> See the probes user manual	
<b>CT probes C-6(A)</b>			
0..12 A	4 s.d.	<b>Additional uncertainty</b> See the probes user manual	
<b>CT probes C-7(A)</b>			
0..100 A	4 s.d.	<b>Additional uncertainty</b> See the probes user manual	
Crest Factor	1..10 (1..3.6 for $I_{nom}$ ) for $I_{RMS} \geq 1\% I_{nom}$	0.01	$\pm 5\%$

### 5.3.5 Frequency

Frequency	Ranges and conditions	Resolution	Basic uncertainty
f	40..70 Hz $15\% U_{nom} \leq U_{RMS} \leq 120\% U_{nom}$ $U_{nom} \geq 100$ V	0.01 Hz	$\pm 0.05$ Hz

### 5.3.6 Harmonics

Harmonics	Ranges and conditions	Resolution	Basic uncertainty
Harmonic (n)	DC, 1..50, grouping: harmonics sub-groups acc. to IEC 61000-4-7		

U <sub>RMS</sub> amplitude	0..200% U <sub>nom</sub>	4 s.d.	±0.15% U <sub>nom</sub> if m.v. <3% U <sub>nom</sub> ±5% m.v. if m.v. ≥ 3% U <sub>nom</sub> (acc. to IEC 61000-4-7 Class II)
I <sub>RMS</sub> amplitude	Depending probes used (see specifications for I <sub>RMS</sub> )	4 s.d.	±0.5% I <sub>nom</sub> if m.v. <10% I <sub>nom</sub> ±5% of m.v. if m.v. ≥ 10% I <sub>nom</sub> (acc. to IEC 61000-4-7 Class II)
Voltage THD-R (n = 2..50)	0.0...100.0% for U <sub>RMS</sub> ≥ 1% U <sub>nom</sub>	0.1%	±5%
Current THD-R (n = 2..50)	0.0...100.0% for I <sub>RMS</sub> ≥ 1% I <sub>nom</sub>	0.1%	±5%
Phase angle (voltage)	-180°...+180°	0.1 °	±(n × 1°)
Phase angle (current)	-180°...+180°	0.1 °	±(n × 1°)

### 5.3.7 Power and energy

Power and energy	Conditions (for power and energy 80% U <sub>nom</sub> ≤ U <sub>RMS</sub> < 120% U <sub>nom</sub> )	Resolution	Basic uncertainty <sup>(1)</sup>
Active power Active energy	2% I <sub>nom</sub> ≤ I <sub>RMS</sub> < 5% I <sub>nom</sub> cosφ = 1	4 s.d.	$\sqrt{2.5^2 + \delta_{ph}^2} \pm \%$
	5% I <sub>nom</sub> ≤ I <sub>RMS</sub> ≤ I <sub>nom</sub> cosφ = 1		$\sqrt{2.0^2 + \delta_{ph}^2} \pm \%$
	5% I <sub>nom</sub> ≤ I <sub>RMS</sub> < 10% I <sub>nom</sub> cosφ = 0.5		$\sqrt{2.5^2 + \delta_{ph}^2} \pm \%$
	10% I <sub>nom</sub> ≤ I <sub>RMS</sub> ≤ I <sub>nom</sub> cosφ = 0.5		$\sqrt{2.0^2 + \delta_{ph}^2} \pm \%$
Reactive power Reactive energy	2% I <sub>nom</sub> ≤ I <sub>RMS</sub> < 5% I <sub>nom</sub> sinφ = 1	4 s.d.	$\sqrt{4.0^2 + \delta_{ph}^2} \pm \%$
	5% I <sub>nom</sub> ≤ I <sub>RMS</sub> < I <sub>nom</sub> sinφ = 1		$\sqrt{3.0^2 + \delta_{ph}^2} \pm \%$
	5% I <sub>nom</sub> ≤ I <sub>RMS</sub> < 10% I <sub>nom</sub> sinφ = 0.5		$\sqrt{4.0^2 + \delta_{ph}^2} \pm \%$
	10% I <sub>nom</sub> ≤ I <sub>RMS</sub> < I <sub>nom</sub> sinφ = 0.5		$\sqrt{3.0^2 + \delta_{ph}^2} \pm \%$
	10% I <sub>nom</sub> ≤ I <sub>RMS</sub> < I <sub>nom</sub> sinφ = 0.25		$\sqrt{4.0^2 + \delta_{ph}^2} \pm \%$
Apparent power Apparent energy	2% I <sub>nom</sub> ≤ I <sub>RMS</sub> < 5% I <sub>nom</sub>	4 s.d.	±2.5%
	5% I <sub>nom</sub> ≤ I <sub>RMS</sub> ≤ I <sub>nom</sub>		±2.0%
Power factor (PF)	0...1 50% U <sub>nom</sub> ≤ U <sub>RMS</sub> < 150% U <sub>nom</sub> 10% I <sub>nom</sub> ≤ I <sub>RMS</sub> < I <sub>nom</sub>	0.01	±0.03
Displacement power factor (cosφ/ DPF)	0...1 50% U <sub>nom</sub> ≤ U <sub>RMS</sub> < 150% U <sub>nom</sub> 10% I <sub>nom</sub> ≤ I <sub>RMS</sub> < I <sub>nom</sub>	0.01	±0.03

(1) See sec. 5.3.8.

### 5.3.8 Estimating the uncertainty of power and energy measurements

The total uncertainty of active and reactive power and energy measurements and the harmonics power is based on the following relationship (additional time measurement uncertainty is omitted in case of energy as much smaller than other uncertainty types):

$$\delta_{p,q} \cong \sqrt{\delta_{U_h}^2 + \delta_{I_h}^2 + \delta_{ph}^2}$$

where:  $\delta_{p,q}$  – uncertainty of active or reactive power measurement,  
 $\delta_{U_h}$  – total uncertainty of voltage harmonic amplitude measurement (analyzer, transducers),  
 $\delta_{I_h}$  – total uncertainty of current amplitude measurement (analyzer, transducers, probes),  
 $\delta_{ph}$  – additional uncertainty caused by the error of phase measurement between the voltage and current harmonics.

The  $\delta_{ph}$  uncertainty can be determined if we know the phase shift angle for a given frequency ranges. Tab. 10 presents the phase difference error between the voltage and current harmonics for the PQM-707 analyzer (without probes and transducers).

**Tab. 10. Phase error in the PQM-707 analyzer depending on the frequency**

Frequency range	0..200 Hz	200..500 Hz	500 Hz..1 kHz	1..2 kHz	2..3 kHz
Phase error	≤1°	≤2.5°	≤5°	≤10°	≤25°

The phase error caused by used transducers and probes can be usually found in their technical documentation. Such being the case, we need to estimate the resultant phase error between the voltage and the current for a given frequency caused by all elements of the measuring circuit: current and voltage transducers, probes, and the analyzer.

The phase uncertainty of the harmonics active power measurements can be calculated according to the following formula:

$$\Delta_{ph} = 100 \left( 1 - \frac{\cos(\varphi + \Delta\varphi)}{\cos\varphi} \right) [\%], \cos\varphi \neq 0$$

On the other hand, the phase uncertainty of the harmonics reactive power measurements can be calculated according to the following formula:

$$\Delta_{ph} = 100 \left( 1 - \frac{\sin(\varphi - \Delta\varphi)}{\sin\varphi} \right) [\%], \sin\varphi \neq 0$$

In both formulas,  $\varphi$  means the actual phase shift angle between the current and voltage components, and  $\Delta\varphi$  means the total phase error for a given frequency. The conclusion which can be drawn from these relationships is that power measurement uncertainty for the same phase error very clearly depends on the displacement power factor between current and voltage. It is shown in Fig. 69.

**Example**

Calculation of measurement uncertainty of active power fundamental component.

Conditions:  $\varphi = 60^\circ$ ,  $U_{RMS} \cong U_{nom}$ ,  $I_{RMS} = 5\% I_{nom}$ .

Fundamental uncertainty equals  $\pm \sqrt{2,5^2 + \delta_{ph}^2}$  %

For the 0..200Hz frequency range, the PQM-707 phase error is  $< 1^\circ$ . After substituting to the equation:

$$\delta_{ph} = 100 \left( 1 - \frac{\cos(\varphi + \Delta\varphi)}{\cos\varphi} \right) = 100 \left( 1 - \frac{\cos(61^\circ)}{\cos(60^\circ)} \right) = 3,04\%$$

then, the measurement uncertainty is:

$$\delta = \pm \sqrt{2,5^2 + 3,04^2} = \pm 3,94\%$$

Under the same conditions, but with the phase shift  $\varphi = 10^\circ$ , we will obtain:

$$\delta_{ph} = 100 \left( 1 - \frac{\cos(11^\circ)}{\cos(10^\circ)} \right) = 0,32\%$$

and the measurement uncertainty is:

$$\delta = \pm \sqrt{2,5^2 + 0,32^2} = \pm 2,52\%$$

The above calculations do not take into account additional errors caused by used probes and transducers.

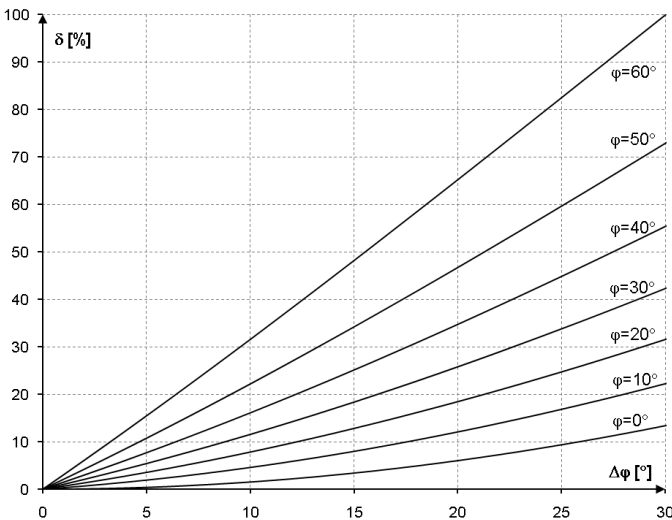

Fig. 69. Additional uncertainty from phase error depending on phase shift angle.

### 5.3.9 Flicker

Flicker	Ranges and conditions	Resolution	Basic uncertainty
$P_{st}$ (10 min), $P_{It}$ (2 h)	0.4 ... 10 for $U_{RMS} \geq 80\% U_{nom}$	0.01	$\pm 10\%$ within the values presented in tables of IEC 61000-4-15 standard

### 5.3.10 Unbalance

Unbalance (voltage and current)	Ranges and conditions	Resolution	Basic uncertainty
Unbalance factor for positive, negative and zero sequence	0.0% ... 10.0% for $80\% U_{nom} \leq U_{RMS} < 150\% U_{nom}$	0.1%	$\pm 0.15\%$ (absolute uncertainty)

## 5.4 Event detection – voltage and current RMS

$U_{RMS}$ voltage (dips, interruptions and swells)	Range	Resolution	Basic uncertainty
$U_{RMS(1/2)}$	0.0%...120.0% $U_{nom}$	4 s.d.	$\pm 1\% U_{nom}$
Detection thresholds	Set by the user in percentage or absolute values. Event detection based on the measurement of $U_{RMS(1/2)}$ (1-period RMS refreshed every $\frac{1}{2}$ period).		
Duration	hh:mm:ss.ms	$\frac{1}{2}$ period	One period
Waveform record	Two periods before event + 4 periods after the event (total of 6 cycles) 204.8/170.67 (50 Hz/60 Hz) samples per period		

$I_{RMS}$ current (min, max)	Range	Resolution	Basic uncertainty
$I_{RMS(1/2)}$	$10\% I_{nom} \leq I_{RMS} < 100\% I_{nom}$	4 s.d.	$\pm 0.5\% I_{nom}$
Detection thresholds	Set by the user in percentage or absolute values. Event detection based on the measurement of $I_{RMS(1/2)}$ (1-period RMS refreshed every $\frac{1}{2}$ period).		
Duration	hh:mm:ss.ms	$\frac{1}{2}$ period	One period
Waveform record	Two periods before event + 4 periods after the event (total of 6 cycles) 204.8/170.67 (50 Hz/60 Hz) samples per period		

### 5.4.1 Event detection hysteresis

Event detection hysteresis	Range	Calculation method
Hysteresis	0..10%	For voltage: calculated as a percent of nominal voltage. For current: calculated as a percent of max. threshold.

## 5.5 Recording

Recording	
Averaging time <sup>(1)</sup>	1 s, 3 s, 10 s, 30 s, 1 min, 10 min, 15 min, 30 min.
Averaging min / max for $U_{RMS}$ <sup>(2)</sup>	based on $I_{RMS(1/2)}$
Averaging min / max for $I_{RMS}$ <sup>(2)</sup>	based on $I_{RMS(1/2)}$
Recording activation mode	manual starting at the first detected event scheduled (one defined time period)
Measurement configurations	Ability to define an unlimited number of measurement configurations stored in analyzer's internal memory
Recording time	Depending on the configuration (e.g. mains type, averaging time, parameters selected, etc.)
Memory	User replaceable memory card: microSD HC 4 GB (up to 32 GB supported)
Memory model	Linear
Security	Analyzer lock to prevent unauthorized access via 4-digit PIN code

(1) Averaging times shorter than 10 seconds are in fact equal to a multiple of the mains period:

1 s = 50/60 cycles, 3 s = 150/180 cycles.

(2)  $U_{RMS(1/2)}$  and  $I_{RMS(1/2)}$  are RMS values for one period, refreshed every half period..

Recorded parameters	Average value	Minimum value	Maximum value	Instantaneous value
RMS phase-to-phase (depending on the type of system) voltage $U_{RMS}$	•	•	•	
RMS phase-to-phase voltage $U_{RMS}$ (only 3-phase wye with N and split-phase systems)	•			
DC Voltage	•	•	•	
RMS current $I_{RMS}$	•	•	•	
DC current <sup>(1)</sup>	•	•	•	
Frequency f	•	•	•	
Voltage crest factor CF U	•	•	•	
Current crest factor CF I	•	•	•	
Unbalance factors for negative and positive sequence, symmetrical components: negative, positive, zero (voltage) $U_0, U_1, U_2, u_0, u_2$	•	•	•	
Unbalance factors for negative and positive sequence, symmetrical components: negative, positive, zero (current) $I_0, I_1, I_2, i_0, i_2$	•	•	•	
Flicker factor $P_{st}$ and $P_R$				•
Active power (consumed and supplied) $P_+, P_-$	•	•	•	
Reactive power (consumed and supplied) $Q_{1+}, Q_{1-} / Q_{B+}, Q_{B-}$	•	•	•	
Apparent power S	•	•	•	
Distortion power D / Apparent distortion power $S_N$	•	•	•	
Power factor PF	•	•	•	
Displacement power factor $\cos\phi$ /DPF	•	•	•	
Tan $\phi$ factor	•	•	•	
Active energy (consumed and supplied) $E_{P+}, E_{P-}$				•
Reactive energy (consumed and supplied) $E_{Q+}, E_{Q-}$				•
Apparent energy $E_S$				•
Total harmonic distortion for Voltage THD-F	•	•	•	
Total harmonic distortion for current THD-F	•	•	•	
Voltage harmonic amplitudes $U_{h1...h50}$	•	•	•	
Current harmonic amplitudes $I_{h1...h50}$	•	•	•	
Harmonics active and r wactive power $P_{h1...h50}, Q_{h1...h50}$	•	•	•	
Total demand distortion TDD	•			

<sup>(1)</sup> Only with C-5A probes.

## 5.6 Power supply

External power supply	
Nominal voltage range	100-240 V AC, 50-60 Hz
Absolute maximum input voltage	90-264 V AC, 50-60 Hz
Overvoltage category	II 300 V
Output voltage and current	12 V DC 2.5 A
Output power	30 W max.
Power adapter input ratings	
Input voltage range	DC 12 V $\pm$ 10%
Input current	2.5 A max.

Rechargeable battery	
Type, nominal voltage, nominal capacity	Li-Ion 11.1 V 3.4 Ah 37.7 Wh
Cycle life	70% of nominal capacity after 500 charge/discharge cycles
Minimum operational time on battery (fully charged battery, rated temperature range, maximum LCD brightness)	min. 4 h
Typical operational time on battery (fully charged battery, temperature range 0-40°C, LCD brightness 50%)	approx. 6 h
Charging time (battery fully discharged, source: external power supply, ambient temperature range 0...40°C)	max. 2 h
Charging time via USB port (battery fully discharged, analyzer switcher off, external power supply disconnected, ambient temperature range 0...40°C)	approx. 30 h
Current consumption from battery in switched off mode (no external power supply)	< 1 mA
Current consumption from battery in sleep mode (no external power supply)	< 75 mA
Maximum time in sleep mode to fully discharge battery (fully charged battery, no external power supply)	approx. 45 h

## Supported mains types

Types of supported mains (directly and indirectly)	
1-phase	1-phase with a neutral conductor (terminals: L1, N, PE)
2-phase (split-phase)	Split phase with a neutral conductor (terminals: L1, L2, N, PE)
3-phase 4-wire	3-phase with a neutral conductor (terminals: L1, L2, L3, N, PE)
3-phase 3-wire	3-phase Delta (terminals: L1, L2, L3, PE)
3-phase 3-wire Aron / 2-element	3-phase Delta with Aron current measurement (terminals: L1, L2, L3, PE)
3-phase 4-wire (no U L2) / 2 ½ element (no V L2/B)	3-phase 4-wire (terminals L1, L3, N, PE), with U L2 voltage calculated
3-phase open delta	3-phase Open Leg Delta (terminals: L1, L2, L3, PE)
Transducers: 3-phase 4-wire	3-phase 4-wire with voltage transducers (terminals: L1, L2, L3, N, PE)
Transducers: 3-phase 3-wire	3-phase Delta with voltage transducers (terminals: L1, L2, L3, PE)
Transducers: 3-phase 3-wire Aron (2PT's, 2-Elements)	3-phase Delta with voltage transducers and Aron current measurement (terminals: L1, L2, L3, PE)
DC	One channel DC circuit with optional DC current measurement (with C-5A probes) (terminals L1, N)
DC+M	Two channels DC circuit with optional DC current measurement (with C-5A probes) (terminals L1, L2, N)

## 5.8 Supported current probes

Types of supported current probes	
F-1(A)	Flexible probes (Rogowski coil), perimeter: 120 cm, measuring range 3000 A <sub>RMS</sub>
F-2(A)	Flexible probes (Rogowski coil), perimeter: 80 cm, measuring range 3000 A <sub>RMS</sub>
F-3(A)	Flexible probes (Rogowski coil), perimeter: 45 cm, measuring range 3000 A <sub>RMS</sub>
F-2AHD	Flexible probes (Rogowski coil), perimeter: 91,5 cm, measuring range 3000 A <sub>RMS</sub>
F-3AHD	Flexible probes (Rogowski coil), perimeter: 45 cm, measuring range 3000 A <sub>RMS</sub>
F-1A6	Flexible probes (Rogowski coil), perimeter: 120 cm, measuring range 6000 A <sub>RMS</sub>
F-2A6	Flexible probes (Rogowski coil), perimeter: 80 cm, measuring range 6000 A <sub>RMS</sub>
F-3A6	Flexible probes (Rogowski coil), perimeter: 45 cm, measuring range 6000 A <sub>RMS</sub>
F-1A1	Flexible probes (Rogowski coil), perimeter: 120 cm, measuring range 1500 A <sub>RMS</sub>
F-2A1	Flexible probes (Rogowski coil), perimeter: 80 cm, measuring range 1500 A <sub>RMS</sub>
F-3A1	Flexible probes (Rogowski coil), perimeter: 45 cm, measuring range 1500 A <sub>RMS</sub>
C-4(A)	CT, AC probes, measuring range 1000 A <sub>RMS</sub>
C-5A	CT, AC/DC probes with Hall sensor, measuring range 1400 A <sub>RMS</sub>
C-6(A)	CT, AC probes for low currents, measuring range 12 A <sub>RMS</sub>
C-7(A)	CT, AC probes, measuring range 1000 A <sub>RMS</sub>

## 5.9 Communication

Communication	
USB	Double insulated from measured mains (CAT IV 600 V) Compatible with USB 2.0

## Environmental conditions and other technical data

Environmental conditions	
Operating temperature range:	-10°C...+50°C
Storage temperature range	-20°C...+60°C
Humidity	10...90% no condensation
Ingress protection (according to EN 60529)	IP 51
Operating altitude	up to 2000 m (up to 4000 m with derated measurement category CAT II 760 V / CAT III 600 V / CAT IV 300 V)
Reference conditions	see Tab. 9
Dimensions	288 x 223 x 75 mm (with cover)
Weight	ok. 1,75 kg (with cover)
Display	color LCD TFT with polytouch, 800x480 resolution, diagonal 7"
Data memory	Removable microSD memory card 4 GB (as standard) for measurement data, screenshots and reports; option of extending up to 32 GB. Internal memory (approx. 1GB) for configuration data.

## 5.11 Safety and electromagnetic compatibility

Safety and EMC	
Compliance with	IEC 61010-1 edition 3.0, IEC 61010-2-030
Measurement Category	IV 600V / III 760 V, pollution class 2, according to IEC 61010-2-030
Insulation	Double
Electromagnetic compatibility	IEC 61326
Immunity to radio frequency interferences	IEC 61000-4-3 sinusoidal modulation 80% AM, 1 kHz 80...1000MHz, 10 V/m 1.4...2.0 GHz, 3 V/m 2.0 ... 2.7 GHz, 1 V/m
Immunity to electrostatic discharge	IEC 61000-4-2 Air discharge: 8 kV Contact discharge: 4 kV
Immunity to conducted disturbances, induced by radio-frequency fields	IEC 61000-4-6 sinusoidal modulation 80% AM, 1 kHz 0.15...80 MHz, 10V
Immunity to a series of electrical fast transients/bursts	IEC 61000-4-4 Amplitude of 2 kV, 5 kHz
Surge immunity	IEC 61000-4-5 Amplitude 2 kV (L-L)
Emission of radiated RF disturbances	IEC 61000-6-3 30...230 MHz, 40 dB( $\mu$ V/m) at 10m 230...1000 MHz, 47 dB( $\mu$ V/m) at 10m
Emissions of conducted interferences	IEC 61000-6-3 Levels for a quasi-peak detector: 0.15 kHz...0.5 MHz: 66 dB $\mu$ V...56 dB $\mu$ V 0.5 MHz...5 MHz: 56 dB $\mu$ V 5 MHz...30 MHz: 60 dB $\mu$ V

### EN 55022 Compliance statement:

PQM-707 is a class A product. In a domestic environment this product may cause radio interference in which case the user may be required to take adequate measures (e.g. increasing the distance between affected products).

## Standards





Standards	
Measurement Methods	IEC 61000-4-30 Class S
Measurement Accuracy	IEC 61000-4-30 Class S
Power Quality	EN 50160
Flicker	IEC 61000-4-15
Harmonics	IEC 61000-4-7
Safety	IEC 61010-1, IEC 61010-2-030
EMC	IEC 61326
Quality standard	design, construction and manufacturing are ISO 9001 compliant

## Rechargeable battery

### 6.1 Genral information

PQM-707 is equipped with a Li-Ion battery pack 11.1 V 3.4 Ah. The battery pack includes a circuit monitoring its charge status, which provides precise level of battery pack charge and a temperature sensor.

The charge level of the battery pack is indicated by icon on the top bar of the screen on the right side:

-  - charge level 80...100%
-  - charge level 60...80%
-  - charge level 40...60%
-  - charge level 20...40%
-  - charge level 0...20%

If the device detects the absence of the battery pack or no communication with the pack, the following icon is displayed:

-  - a problem with the battery pack (removed or lack of communication)

Charging the battery pack is started automatically after connecting power supply adapter 12 V DC to the analyzer. It is also possible to charge it from the car cigarette lighter socket using a special cable provided with the analyzer. Charging is indicated by animated battery icon on the top bar and LED (see description in sec. 2.5). The temperature of the battery back and the ambient temperature influence the charging process. If the battery temperature is below 0°C or higher than 45°C, the charging process is stopped.

### 6.2 Replacing rechargeable batteries

The internal real time clock is supplied from the battery pack, therefore to avoid losing the clock settings, the battery pack replacement may be performed with connected power supply of 12 V DC. To replace the battery pack:

- disconnect the meter from the tested network,
- connect the external power supply 12 V DC (to prevent resetting date and time settings)
- Remove the four screws of the rechargeable batteries/batteries compartment (in the lower part of the casing), see Fig. 70,
- Remove the compartment,
- insert a new battery pack into the meter,
- Screw the four screws of the rechargeable batteries/batteries compartment.

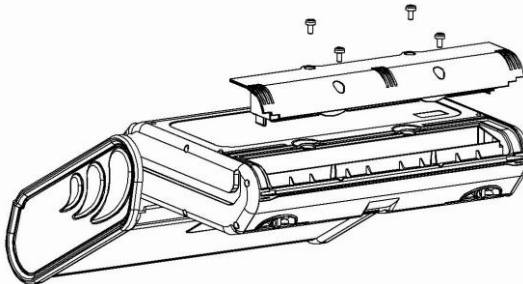

Fig. 70. Replacing the battery pack

## 7 **Cleaning and maintenance**

**Note**

*Use only the maintenance methods specified by the manufacturer in this manual.*

The casing of the analyzer may be cleaned with a soft, damp cloth using all-purpose detergents. Do not use any solvents or cleaning agents which might scratch the casing (powders, pastes, etc.). Cables should be cleaned with water and detergents, and then dried. The analyzer electronic system does not require maintenance.

## 8 **Storage**

In the case of storage of the device, the following recommendations must be observed:

- Disconnect all the test leads from the meter.
- Clean the meter and all its accessories thoroughly.
- In order to prevent a total discharge of the accumulators in the case of a prolonged storage, charge them from time to time.

## 9 **Dismantling and disposal**

Worn-out electric and electronic equipment should be gathered selectively, i.e. it must not be placed with waste of another kind.





Worn-out electronic equipment should be sent to a collection point in accordance with the law of waste electrical and electronic equipment.





Before the equipment is sent to a collection point, do not dismantle any elements.

Observe local regulations concerning disposal of packages, waste batteries and accumulators.

## 10 Optional accessories

- The parameters apply to clamps currently on offer. For the parameters of all clamps in a given series, please refer to the user manual of the respective accessory.
- The full list of accessories can be found on the manufacturer's website.

				
	C-4A	C-5A	C-6A	C-7A
	WACEGC4AOKR	WACEGC5AOKR	WACEGC6AOKR	WACEGC7AOKR
<b>Rated current</b>	1000 A AC	1000 A AC 1400 A DC	12 A AC	100 A AC
<b>Frequency</b>	30 Hz...5 kHz	DC...5 kHz	40 Hz...10 kHz	40 Hz...1 kHz
<b>Max. diameter of measured conductor</b>	52 mm	39 mm	20 mm	24 mm
<b>Minimum accuracy</b>	≤0,5%	≤1.5%	≤1%	0,5%
<b>Battery power</b>	—	√	—	—
<b>Lead length</b>	2.2 m	2.2 m	2.2 m	3 m
<b>Measurement category</b>	III 600 V IV 300 V	IV 300 V	III 600 V IV 300 V	III 300 V
<b>Ingress protection</b>	IP40			

					
	F-1A1 / F-1A / F-1A6	F-2A1 / F-2A / F-2A6	F-3A1 / F-3A / F-3A6	F-2AHD	F-3AHD
	WACEGF1A1OKR WACEGF1AOKR WACEGF1A6OKR	WACEGF2A1OKR WACEGF2AOKR WACEGF2A6OKR	WACEGF3A1OKR WACEGF3AOKR WACEGF3A6OKR	WACEGF2AHDOKR	WACEGF3AHDOKR
<b>Rated current</b>	1500 / 3000 / 6000 A AC	1500 / 3000 / 6000 A AC	1500 / 3000 / 6000 A AC	3000 A AC	
<b>Frequency</b>	40 Hz...10 kHz			10 Hz...20 kHz	
<b>Max. diameter of measured conductor</b>	380 mm	250 mm	140 mm	290 mm	145 mm
<b>Minimum accuracy</b>	0.5%			0.5%	
<b>Battery power</b>	—			—	
<b>Lead length</b>	2.5 m			2.5 m	
<b>Measurement category</b>	III 1000 V IV 600 V			III 1000 V IV 600 V	
<b>Ingress protection</b>	IP67			IP65	

## 11 Positions of the meter's cover

The movable cover enables using the meter in various positions.

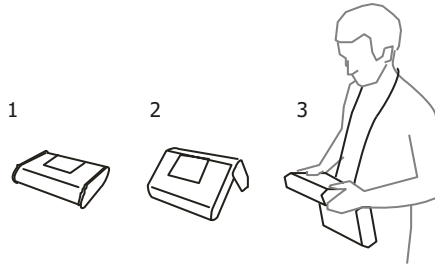

1 – cover as the bottom of the meter,

2 – cover used as a support,

3 – cover in the position that enables convenient use of the meter suspended on the neck by means of hanging straps.

## 12 Manufacturer

The manufacturer of the device and provider of guarantee and post-guarantee service:

**SONEL S.A.**

Wokulskiego 11

58-100 Świdnica

Poland

tel. +48 74 884 10 53 (Customer Service)

e-mail: [customerservice@sonel.com](mailto:customerservice@sonel.com)

web page: [www.sonel.com](http://www.sonel.com)

**Note**

*Service repairs must be performed only by the manufacturer.*

**NOTES**





**SONEL S.A.**

Wokulskiego 11  
58-100 Świdnica  
Poland

**Customer Service**

tel. +48 74 884 10 53  
e-mail: [customerservice@sonel.com](mailto:customerservice@sonel.com)

[www.sonel.com](http://www.sonel.com)