



USER MANUAL

**CABLES AND UNDERGROUND
INFRASTRUCTURE LOCATOR**

LKZ-1500-LITE • LKZ-1500



USER MANUAL

CABLES AND UNDERGROUND INFRASTRUCTURE LOCATOR

**LKZ-1500-LITE
LKZ-1500**



**SONEL S.A.
Wokulskiego 11
58-100 Świdnica**

Version 2.01 12.01.2022

Locator LKZ-1500 is a modern, high quality measuring device, easy and safe to use. Reading and using of this manual will help to avoid errors in measurements and prevent possible problems when operating the instrument.

TABLE OF CONTENT

1 Safety	5
2 Description of the system	6
3 LKN-1500 transmitter	6
3.1 Operating principle of the transmitter LKN-1500	7
3.2 Design and front panel of the transmitter	7
3.3 Safety measures	8
3.4 Operating the transmitter	9
3.4.1 Signaling of the status and modes of operation of the transmitter	9
3.4.2 Direct connection – galvanic mode	10
3.4.2.1 Connecting the transmitter to the object	10
3.4.2.2 Signal frequency selection	10
3.4.2.3 Signal power output settings	11
3.4.2.4 Transmitter operation mode selection	11
3.4.2.5 Voltage output limitation	12
3.4.3 Non-contact survey current generation in communication line	12
3.4.3.1 Internal transmitter inductor	12
3.4.3.2 Inductive clamps	13
4 LKO-1500-LITE / LKO-1500	14
4.1 Principles of operation	14
4.2 Design and front panel of the receiver	14
4.3 Operating the receiver	18
4.4 LKO-1500 Selection and setting the main parameters via Menu options	18
4.5 LKO-1500 Operating modes of the receiver	21
4.6 Locating methods	23
4.6.1 Selection of operating frequency	23
4.6.2 Peak, null and current direction modes	23
4.6.2.1 Peak mode	24
4.6.2.2 LKO-1500 Peak search with 1:4 scale	25
4.6.2.3 The null method	26
4.6.2.4 LKO-1500 Locating with “Compass line” option	27
4.6.2.5 LKO-1500 Locating by current direction	29
4.6.3 Depth and current intensity of the utilities	30
4.6.3.1 Measurement of depth	31
4.6.3.2 Measurement of current	31
4.6.3.3 Indirect 6 dB test method for depth measurement	32
4.6.3.4 Locating by the utility current	33
4.7 Testing of ground plots	34
4.7.1 Passive locating without Transmitter	34
4.7.2 Testing of ground plots with LKN transmitter	35
4.7.2.1 One-man test method	35
4.7.2.2 Two-man test method	36
5 Methods of locating damaged pipelines and utilities	37
5.1 Fault finding with leakage current	37
5.2 LKO-1500 Fault finding with insulation control sensors – DKI-E or A-frame	37
5.2.1 Insulation fault finding by signal drop	38
5.2.2 The search of the insulation failure by the signal rise	39
5.2.3 Cable breakdown location	40

5.2.3.1	<i>Finding of short-circuited conductors</i>	40
5.2.3.2	LKO-1500 <i>Location of shorted conductor-shield positions</i>	40
5.2.3.3	LKO-1500 <i>Tracing of damaged insulation and grounding area</i>	41
6	<i>Data storage, GPS navigation</i>	42
6.1	<i>Adjustment of the Receiver to the GPS modules</i>	43
6.2	<i>Track recording</i>	44
6.2.1	<i>Recording with button</i>	44
6.2.2	<i>Auto tracking</i>	44
6.2.3	<i>Log</i>	45
6.2.4	<i>Distance</i>	45
6.2.5	<i>Transmission to PC</i>	45
7	<i>Power supply</i>	46
7.1	<i>LKN-1500 power supply</i>	46
7.2	<i>LKO-1500-LITE / LKO-1500 power supply</i>	46
8	<i>Possible faults and troubleshooting</i>	47
8.1	<i>LKO-1500 transmitter</i>	47
8.2	<i>LKO-1500-LITE / LKO-1500 receiver</i>	47
9	<i>Maintenance and running repairs</i>	48
10	<i>Transportation and storage</i>	48
11	<i>Dismantling and utilization</i>	48
12	<i>Technical data</i>	49
12.1	<i>LKN-1500 transmitter</i>	49
12.1.1	<i>Basic technical data</i>	49
12.1.2	<i>Other technical data</i>	50
12.2	<i>LKO-1500-LITE / LKO-1500 receiver</i>	50
12.2.1	<i>Basic technical data</i>	50
12.2.2	<i>Other technical data</i>	51
13	<i>Accessories</i>	52
13.1	<i>Standard accessories</i>	52
13.2	<i>Optional accessories</i>	52
14	<i>Service</i>	53
15	<i>Laboratory services</i>	54

1 Safety

To ensure adequate service and correctness of the results obtained, the following recommendations must be observed:

- Please read this manual thoroughly before using the set, and follow the safety regulations and manufacturer's instructions.
- Any use of the kit other than those specified in this manual, may result in a damage to the device and will be a source of serious danger to the user.
- The LKZ-1500 kit can only be used by qualified persons with the required electrical work permit. Using the kit by unauthorized persons may damage the device and cause serious danger to the user.
- The use of this manual does not exclude the necessity of observing safety rules and other relevant regulations required for the performance of given kinds of work. It is essential to consult a person responsible for health and safety at work, before working with equipment in unsafe conditions, for example in dangerous atmosphere which may cause explosion or fire.
- It is unacceptable to use a tool that has been damaged and is totally or partially inoperable, e.g. with damaged cables or stored for long periods of time in poor conditions.
- Do not leave the transmitter connected to the object unattended.
- Do not disconnect the wires from the object while the transmitter is operating.
- Repairs may only be carried out by an authorized service center.



WARNING

Disconnecting the protective conductor is a serious life threat for executives and outsiders. Wherever possible, disconnect the mains voltage and the phase conductor (conductors) as soon as possible. Take special care when disconnecting the protective conductor or grounding of the neutral conductor from the system that must be live. Ensure that no outsiders are present in the danger area. Once the location is complete, it is essential to restore the protective earth conductor.



NOTE!

- The LKN-1500 transmitter is designed for use on non-voltage objects. Connecting to a 230 V network may cause damage. The transmitter generates dangerous voltage up to 250 V.
- Please read this manual before turning on the transmitter.



- Due to the continuous development of the device software, the appearance of the displays for some functions may be slightly different than those shown in this manual.
- Due to a continuous development of the product and the implementation of the changes, in order to increase reliability and improve working conditions, there are slight differences between the product and the description of its construction in this user manual.

2 Description of the system

The LKZ-1500 locator system consists of an LKO-1500 receiver and an LKN-1500 transmitter kitted as follows:

- **LKZ-1500-LITE** is a kit of LKN-1500 with LKO-1500-LITE;
- **LKZ-1500** is a kit of LKN-1500 with LKO-1500.

The system allows to track a route of the underground objects like:

- Electrical wires and power cables,
- Control and telecommunication lines,
- Lightning protection and cathodic protection,
- water and sewage installations,
- heating systems and pre-insulated pipes,
- other metal objects that can conduct electricity.

LKO-1500

The icon with the meter name is placed next to sections of the text that refer to specific features of the device. All other parts of the text relate to all types of the instrument.

3 LKN-1500 transmitter

The transmitter is designed for generating and transmitting signals in the line under study, and together with the LKO receiver, it allows to locate the track, determine the burial depth of object, as well as the location of insulation damage, e.g. cables or pipelines. Current output waveform for LKN-1500 is modified sine wave.

The transmitter can cooperate with any LKO receiver that has the same frequency. Transmitters are powered by integral maintenance-free sealed accumulator. External 12 V 7 Ah DC source is allowed for use to provide the required power.

Supply voltage self-check system of transmitter indicates its reduction in the range from 11.0 to 10.5 V. If the supply voltage drops between 10.0 and 10.5 V, the transmitter shuts down automatically.



NOTE!

Periodically recharge the battery to the nominal charge voltage. A deep battery drain (which is less than 10 V) which may occur during prolonged storage will irreversibly damage the battery, which will require its replacement.

The transmitter's accumulator charging mode is activated automatically when connecting power supply unit. Transmitter provide accumulator overcharge protection. The transmitter can operate in 3 signal generation modes:

- a) continuous wave generation;
- b) pulsing generation $\frac{2}{3}$ (signal generation – 1 sec, pause – 0.5 sec);
- c) pulsing generation $\frac{1}{2}$ (signal generation – 0.5 sec, pause 0.5 sec).

3.1 Operating principle of the transmitter LKN-1500

Operating principle of the transmitter is based on DC source energy conversion to AC signal. So, the transmitter microprocessor produces control pulses. Microprocessor also controls transmitter's conditioning by load to provide maximum power output. The transmitter operation and status information is presented on front panel display.

3.2 Design and front panel of the transmitter



Fig. 1 Design of the LKN-1500 transmitter

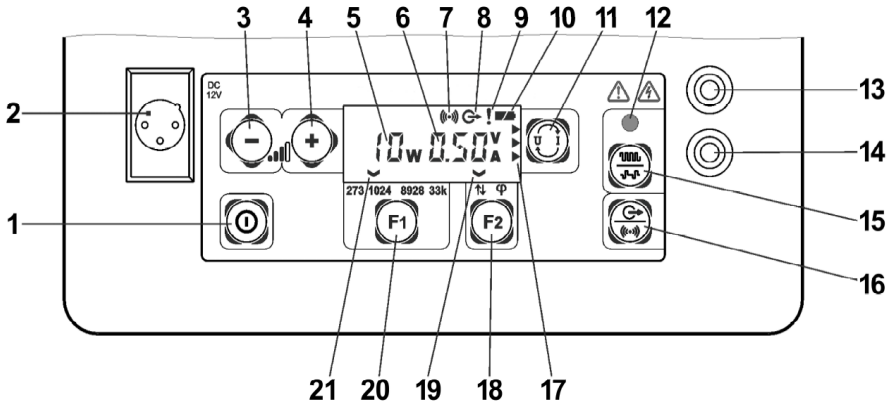

Fig. 2 Front panel of LKN-1500 transmitter

Tab. 1 Description of the control panel and display of LKN-1500 transmitter

No.	Description
1.	Transmitter on / off button
2.	Power supply unit connector for integral accumulator charging or operation from a boost battery
3.	Power output decrease button
4.	Power output increase button
5.	Indication of power output
6.	Current output (A) or voltage (V) indicator
7.	The symbol of internal inductor's signal
8.	The symbol of signal passing through "Output" sockets
9.	External power source status indicator (symbol)
10.	Internal accumulator status indicator (symbol)
11.	Displayed parameter selection button: value of the output current [A] or voltage [V]
12.	Transmitter output signal condition
13.	"Output" sockets for load connection
14.	Socket for connection of grounding probe
15.	"Generation mode" button is used to set continuous wave or pulsing generation mode (see pos. 3)
16.	Option button for signal transmission: induction or direct galvanic connection
17.	Indication symbols of internal accumulator charging process
18.	Button for selecting the signal type: double / single
19.	Double-frequency selection indicators
20.	Signal frequency selection button
21.	Indicators of specified frequency rates

3.3 Safety measures

The transmitter shall be operated in compliance with electrical safety requirements by skilled personnel who learned this operation manual and have the required electrical safety access qualification level.



WARNING

- During operation voltage output level across "Output" sockets and connected circuits may reach 240 V. In operating condition avoid contact with conductive parts connected to the transmitter.
- The transmitter shall be switched off during connection to and disconnection from the examined line or object.



NOTE!

- Before operation check the status of "Output" sockets, the surface around them, and clean if needed. Do not use the transmitter and its component parts in the event of mechanical damage. During operation prevent moisture getting into the transmitter panel and/or power supply unit and use it in accordance with the instruction manual.
- Do not expose to direct sunlight in summer season in order to avoid transmitter overheating.





3.4 Operating the transmitter

The transmitter shall be maintained at operating temperature within two hours in case it was stored at a different temperature before.

Switching on and off the transmitter is done by pressing the button  (see p. 1 on Fig. 2). After switching on, the transmitter sets the minimum output power and frequency at 273 [Hz], but the output voltage level is not limited. The transmitter display reads the transmitter's operating mode and the internal battery status or the external power supply status. See also **Tab. 2**.

3.4.1 Signaling of the status and modes of operation of the transmitter

Tab. 2 Status and operation mode light indication

Indicator position in Fig. 2	Indicator status	Transmitter status and operation mode
 p. 8	Flashing light	The transmitter is adjusting to the load.
	Continuous light	Transmitter stabilized the power output with the load.
 P. 15	Continuous green light	Continuous normal operation of the transmitter.
	Flashing green light	Pulse normal operation of the transmitter.
	Flashing red light at a frequency of 1 Hz	Transmitter overheating. Signal is not generated. The generation is resumed only when the transmitter is cooled down, but no sooner than in one minute
	Continuous glowing red	The "Output" sockets carry external voltage. The transmitter might have been connected to live circuit.
 p. 10	Constant glowing	Internal battery voltage in normal.
	Flashing half of the battery symbol	Internal accumulator voltage level ranges from 11.0 to 10.5 V which indicates deep discharge of accumulator battery.
	The battery symbol flashes	The internal battery voltage is below 10.5 V. After 1 minute the transmitter will be automatically switched off.
 p. 9	No signal	Voltage of external power supply in normal range.
	Continuous glowing	The voltage of the external power supply is between 11.0 V and 10.5 V. The external battery is probably discharged.
	Pulsing flashing	The voltage of the external power supply is below 10.5 V. After 1 minute the transmitter will be automatically switched off.
 p. 17	Moving from top to bottom	Accumulator charges.
	Constant lighting of all three icons	Accumulator charged.

3.4.2 Direct connection – galvanic mode

3.4.2.1 Connecting the transmitter to the object



WARNING

Verify that the line to be tested is not at live voltage. Load connection to the transmitter output is allowed only when the transmitter is switched off. The transmitter direct connection to the examined live line is prohibited.

Socket shall be connected to ground pin driven into the ground at a distance of 5-10 m from the route of the object. To increase the survey current, ground pin shall be earthed at a maximum depth.

Connect the blue wire to the output socket of the transmitter  (Fig. 2 p. 14). The other end of the cable, using a blue crocodile, should be fastened to a pre-grounded grounding probe. Use the red wire to connect the output socket of the transmitter (Fig. 2 p. 13) to the conductive part of the object (see Fig. 3).

In the search for unearthed object, for example, gas pipeline or cable, it is preferable to earth the object at far end (see Fig. 4) – it will provide maximum survey current. Otherwise, current will leak off the ground through isolation capacitance and its level will decrease. As a result it will reduce possible search range.

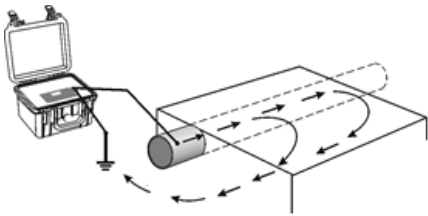

Fig. 3 Connection the transmitter to the metal pipeline.

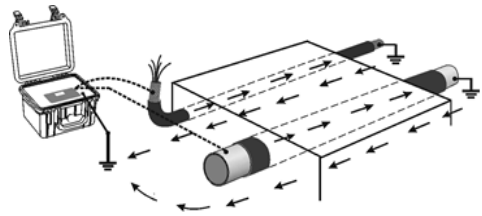





Fig. 4 Connection to cable armour (shield), to one of the cords in case of unshielded cable or to metal section of insulated pipeline

There are other methods of transmitter connection to objects or cables depending on the purposes, for example, in case of insulation fault tracing. For more information see the section on Working with A-frame.

3.4.2.2 Signal frequency selection

Turn on the transmitter and set the desired output frequency, power, and operating mode. In addition, with the button  select the signal output from the transmitter's output sockets. The symbol  will appear on the display. Selection depends on particular search conditions and current task and requires acquisition of practical skills by an operator.

Signal frequency selection is made by pressing the button  and is frequency-loop : 273 → 1024 → 8928 → 33k → 273, etc. (see position 1 in Fig. 2).

Double frequency signal is made by the  key with an indicator \updownarrow for double frequency 1024 [Hz] and ϕ for double frequency 8928 [Hz].

Low signal frequency in the wet ground allows for maximum search range and minimum signal routed to other communication lines or objects (273, 526 or 1024 [Hz]). But at low frequencies the noise influence of power current and signals in adjacent lines is stronger.



High frequency ("8928") in the dry ground allows for higher search range and lower power-supply disturbance. Higher frequency "33k" is recommended when searching for insulated cables and lines with far ends not connected to the ground. In this case, the survey current generated as a result of ground leakage through distributed isolation capacitance is higher. In addition, high frequency is preferable during wire-free connection of the transmitter to the objects or lines of communication (**Fig. 5**).

However, it should be borne in mind that at high frequencies there is a stronger penetration of the signal from the transmitter to adjacent lines (objects), which may result in wrong search directions.

When the transmitter is operated in combination with LKO-1500 receiver, at high density of communication lines, you can use current direction sensing function. The current flow from the transmitter (direct current) or to the transmitter (let-through adjacent line return current). In this regard, set the transmitter signal output at double frequency of 1024 [Hz] signaled $\uparrow\downarrow$. Set operating frequency "1024" for the receiver. Setting the output power of the signal.

3.4.2.3 Signal power output settings

You should correlate the settable power, desired search time, power supply source parameters and estimated search range.

Increase or decrease power output by pressing the buttons . Indicator (pos. 5 Fig. 2) shows power output value. Indicator on position 6 (pos. 6 Fig. 2) shows voltage output (V) and output signal current value (A). Parameter can be selected by pressing the button .

If the desired current value cannot be obtained, check the grounding quality and / or change the signal frequency for the ground type. If the transmitter cannot provide the specified power, it is automatically limited to maximum possible value at the given load. In case of high load circuit resistance when minimum power cannot be generated (for example, open load), power level indicator shows a message: "-1". Also power output limitation may be resulted from insufficient accumulator capacity.

Generally load conditioning time does not exceed one minute. If conditioning is longer, check connections and ground quality, change power output or switch to continuous wave generation mode.



3.4.2.4 Transmitter operation mode selection



Continuous wave and pulsing generation modes are available for the transmitter. Continuous wave generation mode is recommended when determining position of communication lines, its depth and during insulation troubleshooting. Pulsing generation mode is recommended when searching for communication line under high noise conditions or at low signal received, as it's easier to determine your own signal by typical pause in this mode. Also the transmitter power consumption is reduced.

Generation modes from continuous to pulsing are switched by pressing the button  and displayed in time with output signal (the green diode is green) by indicator (pos. 12 Fig. 2).

3.4.2.5 Voltage output limitation

Mode of voltage output limitation to 30 V is activated for safety reasons during operations. For example, it is reasonable to limit voltage output level during cable cord selection in case of body contact with a cord.

To activate voltage output limitation, hold down the button  and press  (pos. 3 in Fig. 2). On the display you will see indicator “V” flashing . In case the transmitter cannot provide pre-set power, it is automatically limited to maximum possible value at the given load.

To deactivate voltage output limitation, hold down the button  and press  (pos. 4 in Fig. 2).

3.4.3 Non-contact survey current generation in communication line

If the transmitter cannot be directly connected to communication line in galvanic mode, for example, no access to conductive parts of communication lines or they carry voltage, the survey current can be generated in the examined lines from induction coil or by inductive clamps.

3.4.3.1 Internal transmitter inductor

The transmitter with coil produces alternating magnetic field in the ground that generates current in the line of communication. The higher is survey current, the lower is resistance of the closed circuit being a part of communication line. Earthing of communication line ends is the best decision as shown in Fig. 5. If there are no earth conductors, the survey current level is lower as its strength is determined by capacitive current through line insulation. The current level is being higher with a rise in frequency.

During operation in inductive mode transmitter shall be installed vertically along an axis of the examined communication line (Fig. 5).

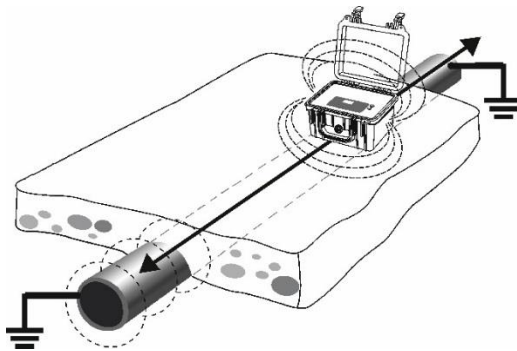



Fig. 5 Induction current excitation in the localized object

For operation from internal inductor press the button . Symbol  will be displayed. The inductor reaches its maximum performance at 33 kHz.

It should be noted that:

- the current level is substantially lower when it is generated in communication line by using transmitter rather than direct galvanic connection;
- transmitting signals are being routed to all adjacent current-conducting lines what may results in wrong search directions;
- the closer transmitter is located to communication line, the higher is the current level generated in communication line.

3.4.3.2 Inductive clamps



In case of access to communication line, for example, high voltage insulated live cable comes out, it is reasonable to use **inductive clamps**. Due to better magnetic interaction with line circuit, they provide higher survey current generation and eliminate sending signal to adjacent communication lines. Select the clamps to match the diameter of the clamped wire (see also **section 13.2**).



NOTE!

Do not connect conductive clamps to live bare conductors.

Current resistance shall be as low as possible in order to provide maximum current in the examined communication line circuit. It should be noted that the higher is operating frequency, the higher is the level of the current generated in insulated and/or unearthed line when using clamps.

The clamps should be connected to the output sockets of the transmitter, while keeping the markings on the wires. The cable marked with the letter **E** with the grounding outlet of the transmitter  and the cable marked with the letter **H** with the load socket (p.13 Fig. 2). Grasp communication line with clamp (**Fig. 6**). On the transmitter panel press the  key to set the frequency from available.

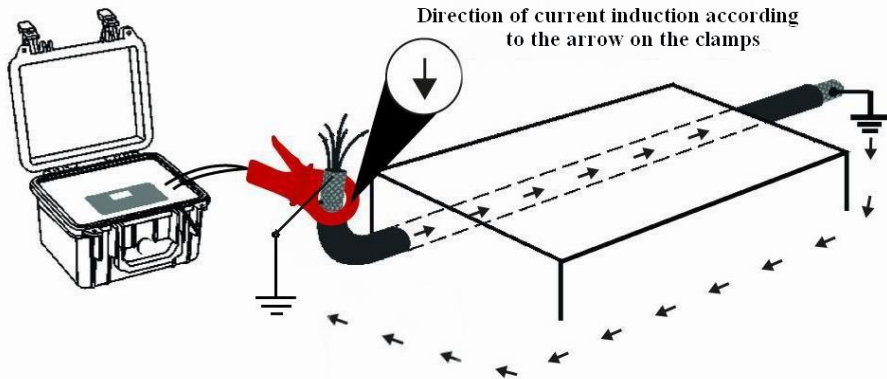

Fig. 6 Induction of excitation voltage in localized object with transmitting clamp

4 LKO-1500-LITE / LKO-1500

The LKO-1500 Receiver paired with the LKN-1500 transmitter is designed to locate and trace cable and pipe lines (hereinafter referred to as the "utilities"). However, there is the possibility of self-operation of the receiver, without aid of the transmitter, i.e.:

- on the 50 Hz and 550 Hz frequencies it locates cable lines by detection induced signal of the industrial frequency current;
- on the 100 Hz and 300 Hz frequencies it locates utilities and finds areas of damaged insulation of pipes by detecting Electrochemical protection signals;
- on the 550 Hz and 1450 Hz frequencies it locates the areas of ground fault of overhead lines by detection current harmonics;
- in the **SB** (sound band) mode it locates utilities by re-radiated broadcasting and telephone signals within the frequency band from 48 Hz to 14 kHz.
- in the **Radio** modes it locates utilities by detecting induced broadcasting signals within the frequency band from 10 kHz to 36 kHz.

4.1 Principles of operation

The Receiver locates utilities and cable faults by the induction method. Replacement sensors facilitate finding damaged insulation by the voltage caused by the current to the ground.

The alternating magnetic field induced by the utility and/or the voltage generated in the replacement sensors are transformed into a signal form. This signal is amplified and processed by the digital signal processor. Then the signal levels are displayed in a form of line bars and digital values in dB or Volts. The indication may be supported with the audible signal.

4.2 Design and front panel of the receiver

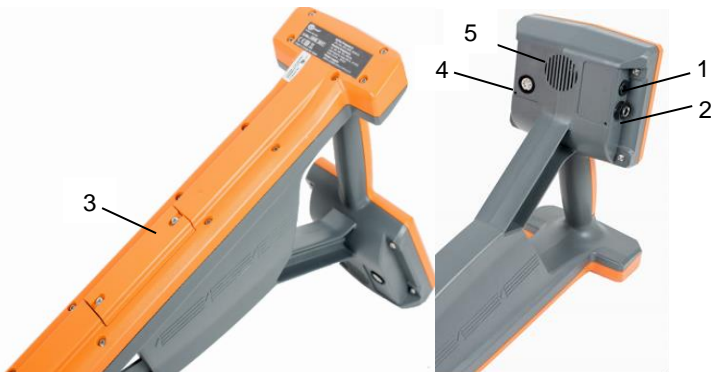



Fig. 7 Design and identification of receiver sockets

No.	Description
1.	Power supply input, 12 V / 0.5 A (the centre pin is negative )
2.	Headphone jack – Jack 6.3 mm
3.	Battery compartment cover
4.	LKO-1500 Outlet for extra equipment (A-frame)
5.	Speaker

A removable sun-protective cover can be installed by securing its two Velcro straps by the receiver's handle for easier operation in sunlight.



Fig. 8 Receiver with sun-protective cover

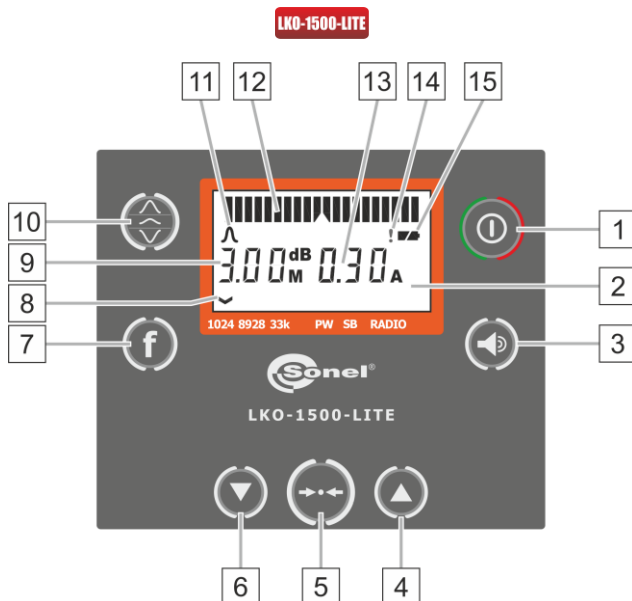

Fig. 9. LKO-1500-LITE receiver panel

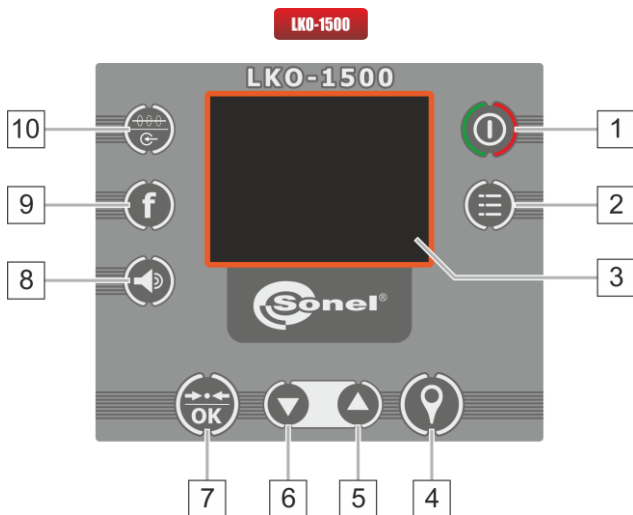



Fig. 10. LKO-1500 receiver panel

Tab. 3 Overview of the LKO-1500 transmitter control panel and display

Lp.	Functions description	
	LKO-1500-LITE	LKO-1500
1.	On/off button	On/off button
2.	Transmitter's display	Menu button – enters / exits the menu
3.	Volume control button	Display
4.	Gain increase buttons	Button for saving displayed parameters and GPS coordinates for further transmission to a PC;
5.	Gain set button for the specific signal strength	Button for increase of the signal, allows movement through the Menu options
6.	Gain reduction buttons	Button for decrease of the signal, allows movement through the Menu options
7.	Operating frequency selector button	Button sets optimum signal gain in the TRACE or SENSOR channels (depending on actual control area). Measures the utility depth and intensity of current. Switches on/off the selected option in the Menu mode.
8.	Operating frequency	Button adjusts the sound volume
9.	Object depth / gain level (dB)	Button switches the available operating frequencies
10.	MODE button for selection of the locating mode: Sharp Peak, Broad Peak, or Null	Button selects available locating modes. Switches the control areas to change operating frequencies and amplify signal between the TRACE and SENSOR channels in the TRACE-SENSOR mode
11.	<p>Enabled locating mode icons:</p>  <p>Sharp Peak Broad Peak Null</p>	-
12.	Input signal strength bar graph	-
13.	Test object current	-
14.	Input signal limit violation icon	-
15.	Battery charge icon	-

4.3 Operating the receiver

Always observe safety rules when you work with live cables.

Do not apply voltage of more than 42 V to the open metal parts or jacks of the Receiver.

If the receiver is at a temperature different from the specified operating temperature, keep it at a working temperature – not less than 1 hour before use.

The instrument should be removed from the case and checked for proper covers, and mechanical damage on the receiver and power supply casing.

Turn off the device with the  button. When powered on, the device turns on the firmware version number and the supply voltage.

LKO-1500-LITE



If the voltage is below 5.8 V, recharge the battery or replace the disposable batteries.

The supply voltage is indicated with the battery icon while the device is on (Fig. 9, item 15). When the battery is fully charged, its charge icon is shown full. If the battery is partially drained, one one half of its charge icon is visible. If the supply voltage falls below 5.8 V, the battery icon begins flashing.



4.4 LKO-1500 Selection and setting the main parameters via Menu options

Press the button , to enter or exit the settings.

The menu is navigated with buttons  . The options may be selected and changed with the  button.

The **Indication** submenu lists the following options.

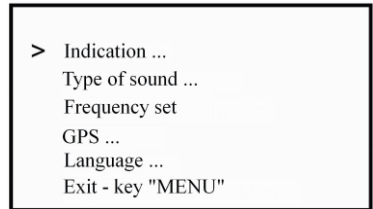

Fig. 11. Main menu

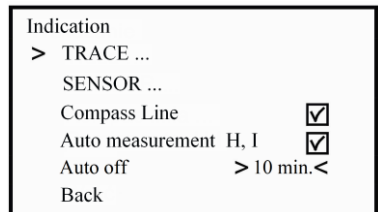

Fig. 12 Menu "Indication" in LKO-1500

- **Trace** – enable/disable the Peak and Null scale indications; select the signal peak limit type.

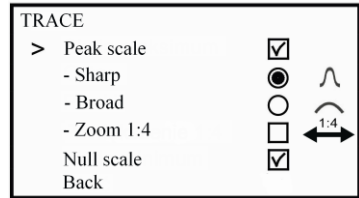

Fig. 13. Menu „Indication”/ „Track”

- **SENSOR** – switch between the dB or V values of the SENSOR input port signal strength; zoom the display 1:4.
- **LK0-1500 H,I auto measurement** – enable/disable continuous on-screen display of the communication line depth (H) and its current flow (I).

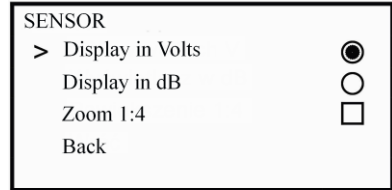

Fig. 14. Menu „Indication”/ „SENSOR”

- **Compass line** – enable/disable the compass line feature.
- **Auto off** – use this option to set the time to automatic shutdown of the instrument. Time selections available: off (auto off disabled) → 10 → 20 →... 90 min. → off. The auto off is set to 30 minutes by default.
- The **Type of sound** submenu provides a selection of audio indication tones as follows.
 - **Tone** – a single frequency tone output. The volume is be directly proportional to the signal strength.
 - **Clicks** – the audio indication tone resembles the ticking of a Geiger counter (radiation dosimeter), and the rate of clicks be directly proportional to the signal strength.
 - **Natural** – for 50 Hz, 60 Hz and Ether (spanning from 48 Hz to 14 kHz and designated as “SB”), the audio indication volume increases with the signal strength (enabling locating “by ear”).

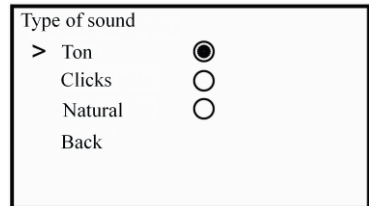





Fig. 15. Menu „Type of sound”

In "Track" mode, the sound reproduces the "peak" signal level. When "Maximum scale" is turned off, sound reproduces the "minimum" scale signal level. In "TRACE SENSOR" mode, the sound reproduces the signal level at the input of the "SENSOR" socket.

In the **Frequency Set** submenu – set the frequency using the up or down arrow button (optionally  or ). Adding or removing frequencies from the list is available by pressing . Exit by pressing the menu button .

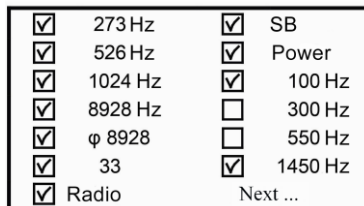

Fig. 16 Menu „Frequency set”

In the **GPS** submenu (see details in **section 6**):

- **Connection to GPS** – connection to a wireless GPS module.
 - **Switching on** – wireless connection.
 - **Searching a GPS Module** – shows currently available devices.
 - **Information** – registry status, current route, date, coordinates...
 - **PIN** – set the PIN code for GPS module pairing.

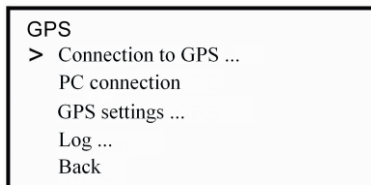







Fig. 17 Menu „GPS”

- **PC connection** – connection to computer;
- **GPS settings** – the settings of the receiver for pairing and operation with the GPS module.
 - Save track as...
 - **New** – new object
 - **Continue in...** – Continue the track (select from among the available in the registry).

Use the up / down arrows to select the register. Confirm with the button  or delete by pressing the button .

- **Autotracking** – to switch on / off automatic recording of track parameters at intervals of 1 sec. up to 60 sec.
- **Distance** – from the last point or from the beginning.
- **Time Zone** – time zones in the world. Set   from -13 to 13.

In the **Language** submenu – select the language with the buttons  .

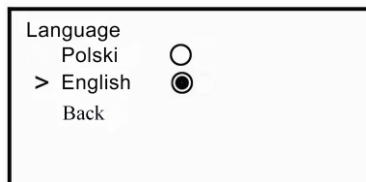



Fig. 18. Menu „Language”

4.5 **LK0-1500** Operating modes of the receiver

The Receiver operates in following modes;

- **TRACE** – to locate the utility and detect its depth and operating frequency current flowing through it. The display of this mode is shown in **Fig. 19**.
- **TRACE-SENSOR** – to locate the utility insulation damage and detect the depth of damaged area; to detect the short-circuited areas or wire break and select the conductors in the multi-core cables. The display of this mode is shown in **Fig. 21**.

To change the mode, press and hold the  button for 2 seconds.

Additionally with the COMPASS LINE option switched on, the direction of the located cable relative to the Receiver will be displayed. The display of the TRACE mode with COMPASS LINE feature is shown in **Fig. 20**, in the TRACE-SENSOR mode – in **Fig. 22**.

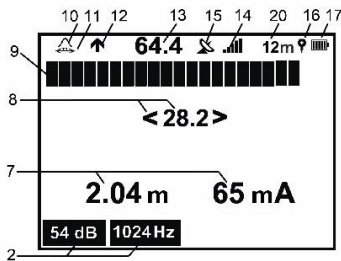

Fig. 19. Display in "Track" mode

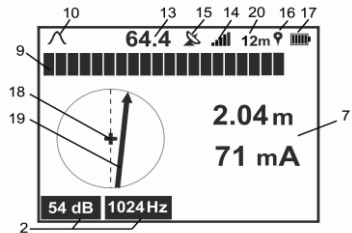

Fig. 20. Display with compass and "Trace" mode

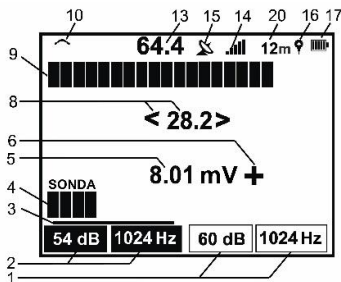

Fig. 21. Display in „Track-SENSOR” mode

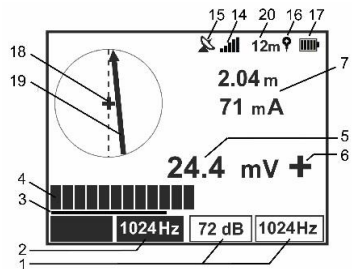









Fig. 22. Display with compass in „Track-SENSOR” mode



The indicator of the input signal strength in dB (for locating by peak and null) turns red when the corresponding input channels are overloaded (See Pos. 13, Pos. 8 **Fig. 19**).

No.	Functions description
1.	Gain and operating frequency of the SENSOR channel
2.	Gain and operating frequency of the TRACE channel
3.	Indicator of effective area for selected gain and/or operating frequency for the TRACE and SENSOR channels. To change the effective area, press the MODE key shortly
4.	The scale of the relative signal's level at the SENSOR jack input
5.	Voltage at the SENSOR jack input – in Volts or dB
6.	Relative polarity of the potential difference caused by the leakage currents at the SENSOR jack input (see sec. 5.2.1)
7.	Indication of the utility depth and the intensity of current via the utility - Green color - exact value - Red color - approximate value (no signal from LKN-1500)
8.	Input signal from the magnetic antenna in dB and also a scale of input signal relative level (null scale) when searching by null method with the preset direction to the utility (see sec. 4.6.2.3)
9.	Relative strength of the input signal (peak bargraph). Locating is performed by the peak method (see sec. 4.6.2.1)
10.	Indication of sharp peak  or broad peak  (see sec. 4.6.2.1)
11.	Indication of scale extension  (see sec. 4.6.2.1)
12.	Direction of current:  – from transmitter;  – to transmitter (see sec. 4.6.2.5)
13.	Input signal from the lower magnetic antenna in dB. Locating is by the peak method (see sec. 4.6.2.1)
14.	Volume indicator
15.	GPS state,  or  (see sec. 6.2)
16.	Logging to the  track, displayed at the moment of recording (see sec. 6.2)
17.	Battery status icon
18.	Receiver axis
19.	Utility position arrow
20.	Distance (see sec. 6.2.4)

4.6 Locating methods

4.6.1 Selection of operating frequency

Frequency selection shall be performed depending on operating conditions, targets and locating method. The operator shall have corresponding qualification and practical skills. Note that the locating effectiveness depends on the mineral contents in the soil, the water in the soil, the electric conductivity and burial depth of the object being located, the proximity of industrial facilities, and many more contributing factors.

We recommend you to start location at low frequencies both by direct connection and induction methods. If the necessary signal strength fails to be reached, you may operate the device at higher frequencies. Low-frequency location provides maximum range of search, especially in the wet soil, and it reduces interferences to other utilities. At the same time, the interferences of power signals and adjacent utilities are stronger at lower frequencies.

At higher frequencies, the range of search is greater in dry or frozen soil, and interferences of power signals and adjacent utilities are lower. Moreover, the signal loss is lower in presence of isolated connectors. The generated signal achieves higher transmission into the adjacent utilities at the same time, which may cause misleading determination of the direction of survey.



It is possible to detect a line (utility) or faults without using the transmitter. The locator can detect the natural frequencies generated by utilities in the following operating mode:

- PWR50, PWR60 – the electrical current frequency (50 Hz, resp. 60 Hz) in industrial-like signals (the fundamental frequency or the harmonics);
- 100 Hz, 300 Hz – the frequency of digital signals;
- SB, Radio – the frequencies of radiotelephone or broadcast signals.



This method may cause false trails since the tracing of the utility may be complicated by branching, and direction of the target utility may not be detected by "own signal". The operator shall have corresponding qualification and practical skills for this method.

4.6.2 Peak, null and current direction modes

The receiver features three (**LKO-1500-LITE**) or four (**LKO-1500**) magnet-mounted antennas. The Receiver shall be arranged vertically.

- The broad peak tracing  – requires a lower horizontal antenna only
- During sharp peak tracing  – two horizontal antennas operate
- In the null locating mode, the receiver operates the following:
 - **LKO-1500-LITE** the horizontal antenna;
 - **LKO-1500** the lower horizontal antenna and the vertical antenna.
- **LKO-1500** **COMPASS LINE** mode requires all 4 antennas of the Receiver.

4.6.2.1 Peak mode

The Receiver is equipped with **sharp peak**  and **broad peak**  functions, which facilitate high accuracy of tracing depending on the depth and density of utilities in the target zone. **Fig. 23** shows the relationship between the signal level and antenna displacement from the utility.

LKO-1500-LITE

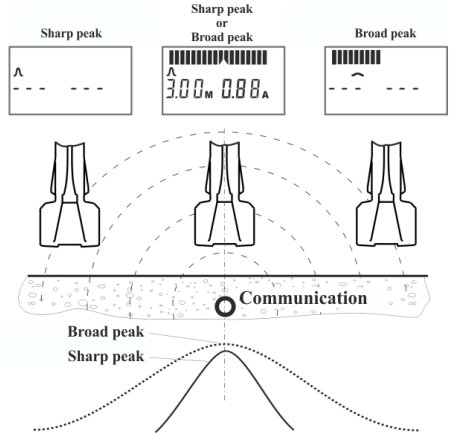

LKO-1500

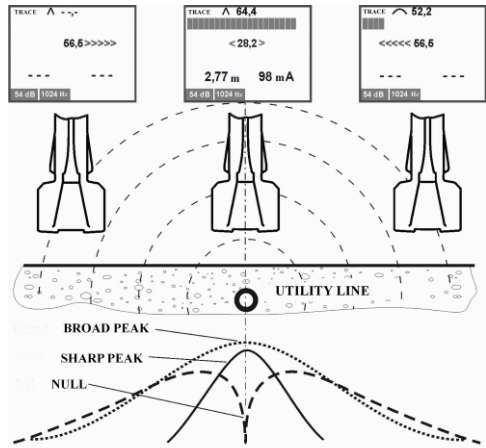



Fig. 23 The level of the responding signal depending on the Receiver displacement from the utility axis

The **sharp peak** method provides high accuracy of the utility tracing since the signal peak near the line axis is on the abrupt area of the graph (see **Fig. 23**, left display). When the antenna is arranged right over the axis of the utility, the responding signal will be on its peak. The signal gain in this point shall be set so that $\frac{3}{4}$ of the scale were lighted; the sound volume shall be adjusted at the level,

comfortable for the operator. The  button may be used to adjust the optimum gain of each specific signal automatically. The indicator bargraph will grow down when the Receiver moves away from the axis. Further displacement of the Receiver will result in disappearing of the linear scale. The --.- icon will appear instead of the signal level indication.

If the signal is weak or the depth of utility is sufficient, the indication on the Peak scale may be unstable or missing. In this case you shall use the **broad peak** method which demonstrates higher sensibility to weak signals.

The indicator scale readings do not depend directly on the location of the Receiver towards the utility at the **broad peak** method since the signal peak is within the broad area of the graph (see **Fig. 23**, right display). However, this method provides maximum sensitivity of the Receiver.

As far as you move along the line, the Receiver gain and the sound volume shall be adjusted depending on the strength of the received signal. Along the route the signal strength may change depending on the cable core twists. The strength of signal may also drop considerably in the areas where the cables are laid under pipelines or near connecting sleeves, or in the areas where they are shielded with metal pipes.

4.6.2.2 **Peak search with 1:4 scale**

In some cases, the peak scale is not sufficient, e.g. when the pipeline branch of smaller diameter is traced deeply under the ground. At that, some portion of tracing current leaks through the branch, and the peak signal strength over the main pipeline drops slightly, and this may go unnoticed.

The option of the peak scale extension may be selected by scrolling the MENU options as follows: **Menu > Indication > Trace > Peak type > Zoom 1:4** (**Fig. 13**). The option reduces the scale divisions to increase its resolution. The  icon will be displayed, a yellow strip will appear under the peak scale to show the expansion bar graph relative to the normal (unexpanded) scale.

Using the gain up/down buttons , place the end of the extended “peak” bar graph within the visible area of the display. The gain-up button expands the scale. The gain-down button makes the scale shorter.

The optimum gain and scale for a specific signal intensity may be obtained by pressing the  button.

4.6.2.3 The null method

The method of null provides precise tracing of single utilities. The null signal is within the abrupt area of the characteristic curve. The method of null provides precise tracing of a single utility line as the minimum signal is surrounded by 2 steep slopes, resulting in a strong signal change, with a slight deviation from the minimum. **Fig. 23** shows relationship between the null signal intensity and the displacement of the antenna away from the target utility. When the antenna is exactly over the axis of the utility, the signal will be on its minimum. When you move the antenna away from the utility, you will get the signal gain, and there will be more lighted segments of the bargraph towards the utility. Subsequent disposal of the antenna will result in smooth signal attenuation.

When you use the null method you should maintain the optimum gain level of the Receiver. If the gain is too low, the bargraph drift from the center will be minor or unnoticeable. If the gain is too high, the bargraph drift may be drastic. This may give the impression of chaotic operation of the Receiver.

When you move along the route of the utility, the signal may rise sharply. This means that the bending (or branching) of utility takes place. The indicator will show its direction.

When you locate the utilities surrounded with other lines and cables, use the method of **sharp peak** since the interferences of adjacent lines is too high during peak tracing.

LKO-1500-LITE

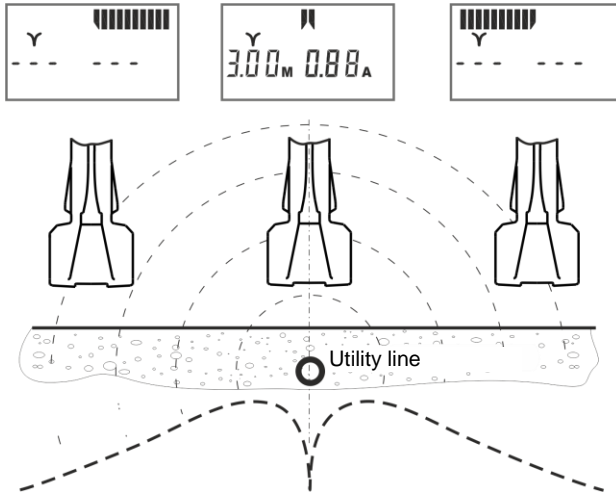



Fig. 24. Signal strength change when the receiver moves perpendicularly away from the utility line



LKO-1500

With the **Compass Line** enabled, the Null scale is not displayed and cannot be enabled.

4.6.2.4 **LKO-1500** Locating with “Compass line” option

The „Compass line mode” is used to facilitate location of single long-distance utility lines with bends and turns. This „Compass line ” shows the orientation of the located utility relative to the Receiver. The option is selected via Menu as follows: **Menu > Indication > Compass Line** then confirmation . The Compass arrow will show the direction of the utility (pos. 19, **Fig. 20, Fig. 22**).

In the **Trace** mode, the Receiver displays the peak scale and input signal strength; in the „Trace-SENSOR” mode, the Receiver displays the scale, strength and polarity of signal at the SENSOR input. Locating with the COMPASS feature is shown in **Fig. 25**.

Moving along the target line, try to arrange the Receiver relative to the utility so that the Utility position arrow (pos. 19 **Fig. 22**) turned to be aligned with the Receiver axis (pos. 18 **Fig. 22**).



The utility position arrow shall be used for visual presentation of utility location only. It shall not be used for precise localization of the target cable. If the signal is weak, the target line environment is crowded and noisy, use the peak method as specified in sec. 4.6.2.1.

The utility position arrow may become fuzzy during location. This may occur when the Receiver is perpendicular to the path of the utility line or the Receiver and target utility are distant, or locating signal is too weak.

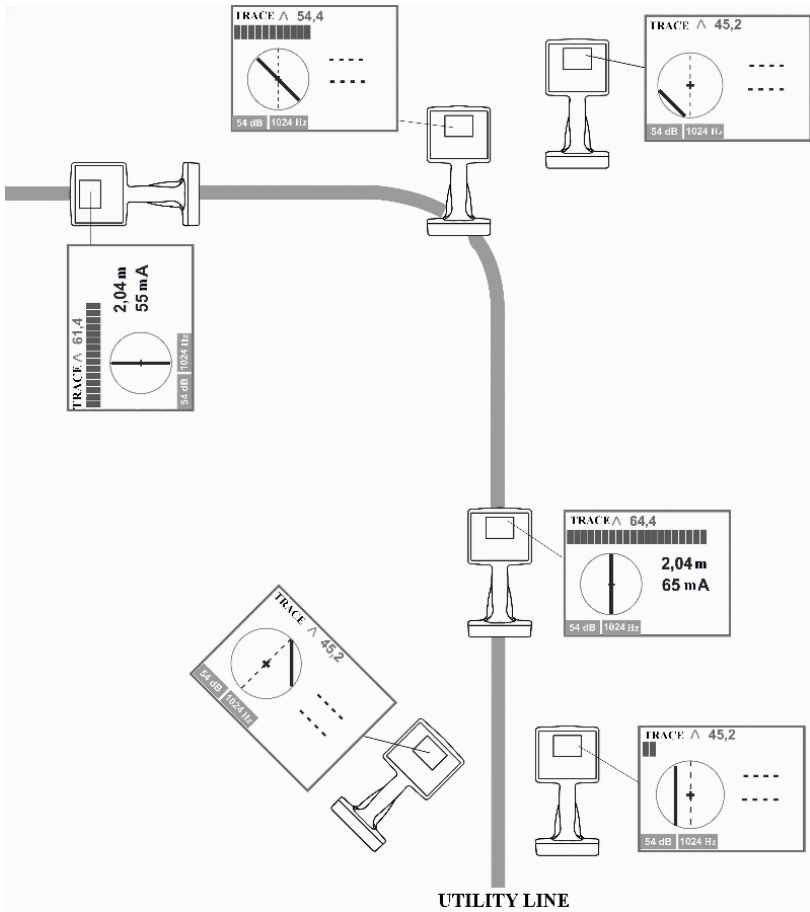

Fig. 25 Locating with "Compass line"

4.6.2.5 **LKO-1500** Locating by current direction

The method of current direction may be used to locate target line in the areas with high concentration of utilities. To do this:

- Enable the **1024 Hz** double-frequency signal generation in the transmitter (section 3.4.2.2);
- Set the receiver to the operating frequency of **1024 Hz**.

If the double-frequency signal strength is sufficient, the indication of current direction (pos. 12 **Fig. 19**) will be active automatically. If the “Compass line” feature is used, the current direction will be shown with the utility position arrow direction (pos. 19 **Fig. 22**).

The Transmitter shall be connected directly to the target line for this technique. The adjacent utilities shall be galvanically separated from the target line in the point of connection (see **Fig. 26**).

The target utility line will carry a current conventionally termed the “output current” of the transmitter (shown with **↑** on the display). Galvanic or capacitive coupling between the target line and the adjacent line will cause the latter to carry the “return current” to the transmitter (shown with **↓** on the display).

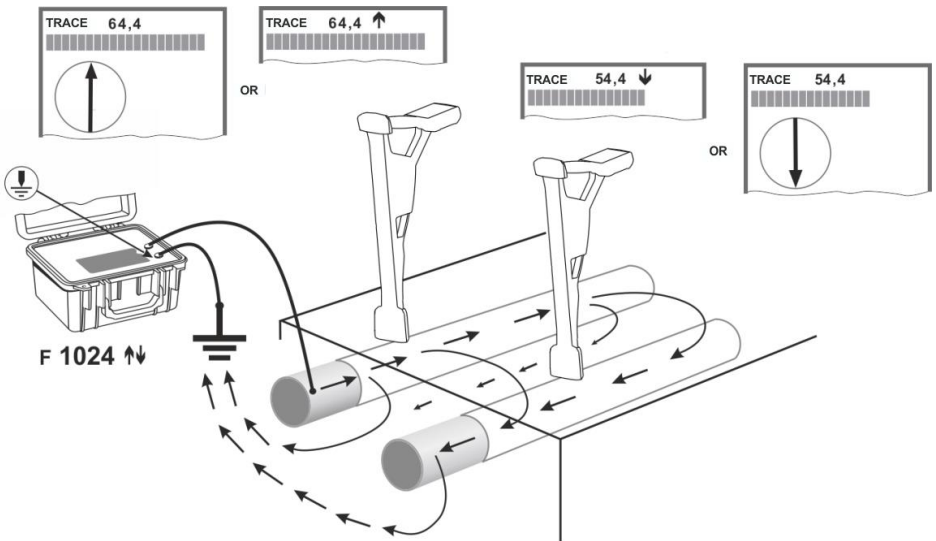

Fig. 26 Direction of current and the locator's readings for galvanically separated piping

In case the adjacent utility lines are galvanically coupled with the target line, all these lines will have the signals of equal direction (See **Fig. 27**). Signal amplitudes of the adjacent lines may differ depending on the search current spreading.

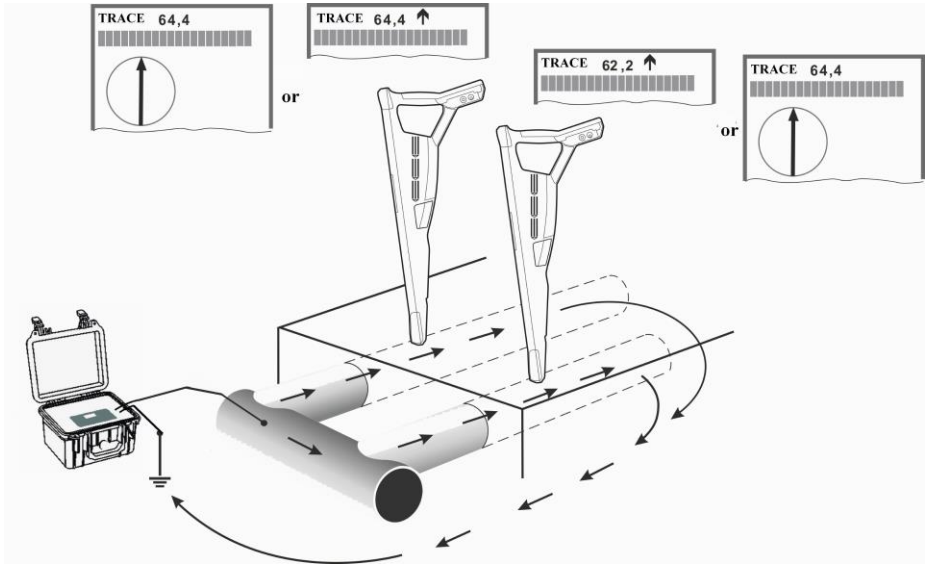

Fig. 27 Direction of current in the galvanically coupled adjacent lines

4.6.3 Depth and current intensity of the utilities

The utility line depth and current strength are not displayed on the **Radio** and **Eter (SB)** frequencies. The error of depth is not rated on the **50 Hz (Power)** frequency.

Using the above techniques, keep the Receiver over the target utility axis, as shown in **Fig. 28**. The arrows on the Receiver body and antenna plain shall be perpendicular to the utility line axis.

Keep in mind that the errors of depth measurements may be caused by the magnetic field distortion produced by adjacent utilities or metal objects, bends or branches, or in high-noise areas. Always observe the rules of operation of the Receiver before operation to ensure against errors.

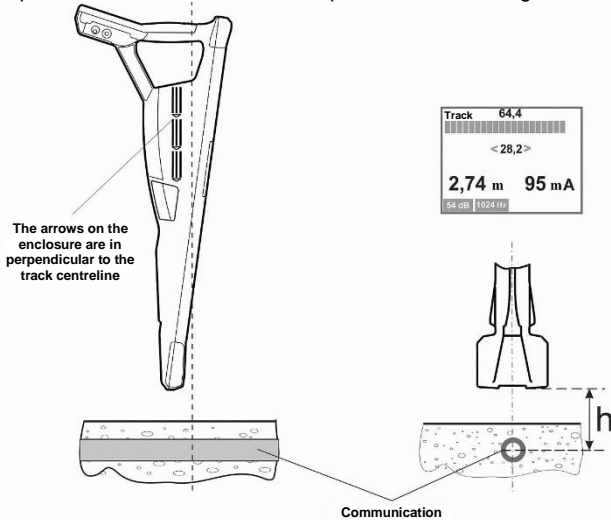

Fig. 28 Direct location of the utility depth

The Receiver displays the depth and current of target line by default. You may switch this function off, and display these data by pressing the  button.

4.6.3.1 Measurement of depth



The depth is measured from the lower surface of the Receiver to the center of the utility line.

Take two or three depth measurements at the same point. The depth level is calculated as the average of the measurement results. Keep the locator straight and 0.3 m above the ground and seek the depth reading again. The depth reading should increase with the locator's height. If feasible to do so, measure the depth at different operating frequencies. As the distance between the locator and the utility's centreline increases, so does the depth reading. The minimum of the depth readings is the most accurate measurement value.

LK0-1500-LITE

The dashes (**Fig. 23** and **Fig. 24**) are displayed when the current and depth measurements are most likely inaccurate; this means that the picked up signal is too weak or the locator is away from the traced utility, or the utility's magnetic field is distorted by the electric current from other utilities nearby. If this happens, the indirect test method is recommended (Section 4.6.3.3).

4.6.3.2 Measurement of current

If there is more than one utility in the surveyed area, the locator might pick up a stronger signal from a line adjacent to the target utility to which the target's signal is coupled or both have a common ground if they are located closer to the terrain surface. However, the target utility will always show the highest of all detected current values, since current is independent from depth. Current measurement facilitates pinpointing the target utility.

To pinpoint the target utility, make sure that its current is stronger than of the adjacent utilities. It is recommended to supply the tracking current from the transmitter to the target utility directly (Section 3.4.2) or indirectly by applying the current clamps.

A sharp change in the utility's current trend may occur at intersections or connection points, as it is where a part of the applied test current may bleed away through branches. According to Kirchhoff's first law, the value of current entering a node must be equal to the value of current leaving the node. However, the current measurement results near branches can be inaccurate. An accurate current measurement is only possible over a long section of the network.



The errors in the depth and current measurements can be an effect of magnetic field distortion by adjacent utilities and nearby metallic features, at utility bends and branch-off points, and a high level of noise or failure to properly operate the instrument.

A current or depth measurement is definitely inaccurate if the picked up signal is too weak or the locator is away from the transmitter, or if the target utility's magnetic field is distorted by the electric current from other utilities nearby (which is evident by the display message "Weak field" or ---). In these circumstances, it is recommended to determine the depth of the utility with the -6dB method (see Section. 4.6.3.3).

4.6.3.3 Indirect 6 dB test method for depth measurement

When the Receiver fails to measure the depth of the utility line or the depth shall be located on the passive frequencies, you may use the indirect method of **-6 dB**.

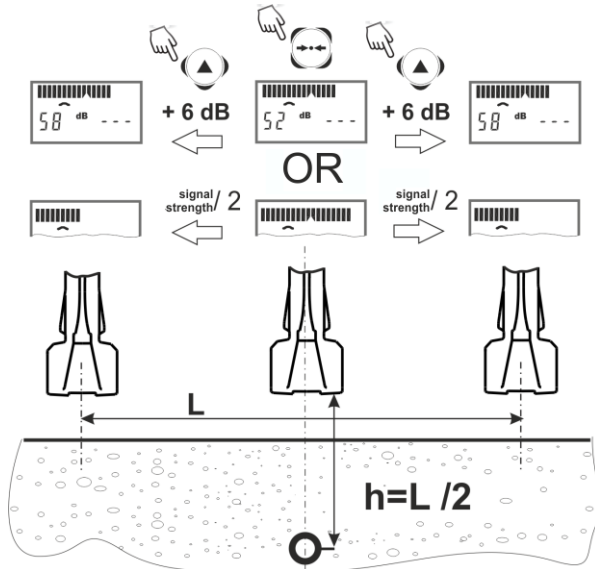

Fig. 29 Depth measurement by the -6dB method (LKO-1500-LITE)

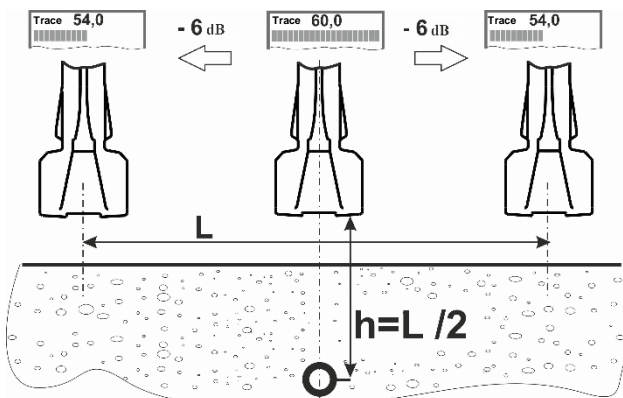

Fig. 30 Depth measurement by the -6dB method (LKO-1500)

Pinpoint the utility axis and store the readings of the input signal strength on the peak scale in dB. Moving to the left and to the right of the utility axis, find the positions in which the readings will be 6 dB less (this means that the signal strength is two times less). The distance between these two points will be equal to double distance from the Receiver to the utility line axis.

4.6.3.4 Locating by the utility current

When several utilities are running close together within the traced area, return signals from wrong lines may cause false retrieval. The problem sometimes occurs when the target line is deeper than the wrong line carrying the return signal, and the return signal from the wrong line is stronger than one from the target line. The current intensity does not depend on the utility depth, and maximum current will be detectable in the target line. The same level of current will be detected in the target line, and the target line will be identified easily.

When you use this technique, please be sure that the current strength in the target line is much higher, than in the adjacent utilities. To achieve this, connect the Transmitter directly to the target line (see Fig. 3 or Fig. 4), or use the current-control clamps (Fig. 6).

Moreover, the abrupt current change may represent branches or tie-in connections of the utilities (if they are made of current-conducting materials), since some current will leak through the branches. The first Kirchhoff's law says that the total current inflowing in a junction is equal to the total outflowing current. You should note, however, that values of the current intensity near the branches will differ from the actual values. Accurate and true measurements may be performed within long-distance and uniform areas only.

4.7 Testing of ground plots

In order to avoid damage, the ground plots shall be tested to locate and trace the current-conducting utilities before excavating.

4.7.1 Passive locating without Transmitter

The territory may be located in response to re-radiated power, telephone, broadcasting signals or signals of electrochemical protection. Make tracing on the frequencies:

- 50 Hz,
- **LKO-1500** 100 Hz,
- **LKO-1500** Eter (SB),
- **LKO-1500** Radio.

Set the Receiver gain so that a half of the “peak” bar graph is illuminated. Move in zigzags, by alternating your direction in perpendicular every 1 to 5 m (**Fig. 31**). The signal strength will peak where the utility is. Survey as explained in Section 4.6.2.1 to confirm that you have pinpointed the utility. Find the direction of the located utility rotating the Receiver on vertical axis. The **peak signal** is generated when the Receiver plane is **perpendicular** to the utility line, the **minimum** one – when it is **parallel**.

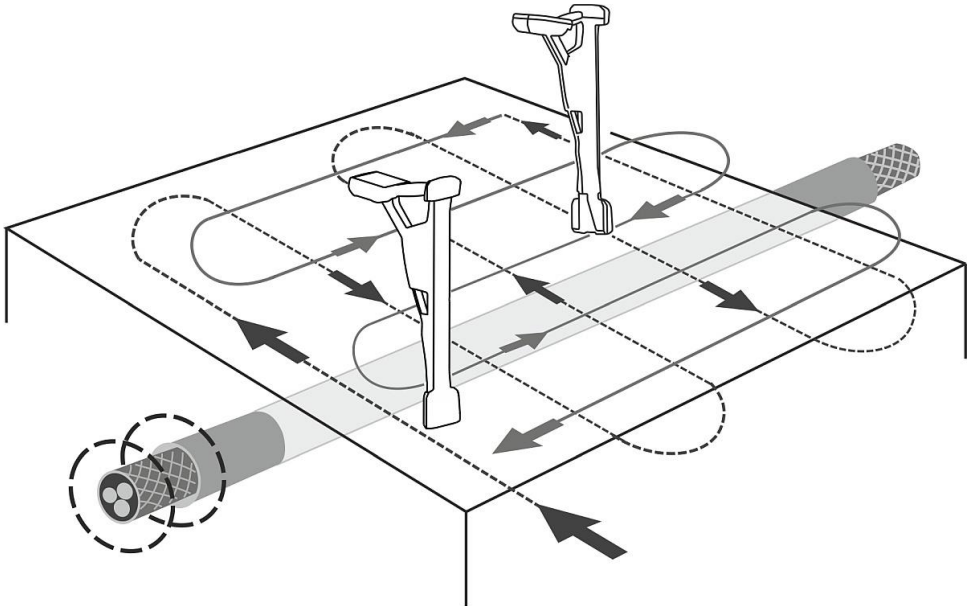

Fig. 31 Testing of ground plots without the LKN Transmitter

If you are locating a single utility line in the area and with a strong signal, it is recommended to enable **Compass line** to facilitate tracking (Section 4.6.2.4).

4.7.2 Testing of ground plots with LKN transmitter

To improve the location reliability it is recommended to trace the utility with the signals generated by the Transmitter either with galvanic coupling or with the internal transmitter antenna.

During the current search line excitation, you should take into account that:

- the high Transmitter power and small distance from the inductors to the Receiver cause strong direct connection, that will drown the utility signals;
- the strength of current induced in the utility line by means of the inductors will be much lower than that at the direct connection;
- the strength of current induced in the utility line by means of the inductors will be high at high operating frequencies of the Transmitter and close location of the inductor to the utility line;
- the utility current strength depends on the grounding on the ends of the utility line. If one of the ground contacts is missed, the location will be difficult, so the Transmitter shall be set on the maximum frequency to increase the currents via the capacity between the utility and ground.

4.7.2.1 One-man test method

This test can be done by dividing the surveyed area into sections measuring from 50x50 m to 100x100 m. Place the LKN transmitter in the centre of each surveyed section (**Fig. 32**). Select inductive mode. Transmitter frequency will be set automatically on 33 kHz. Adjust the Transmitter power to achieve minimum direct connection between inductor and Receiver. In order to test the narrow regions, i.e. a trench, put the inductor apart from the tested area (at the distance from 20 m to 25 m).

Move along the surveyed section's perimeter. The signal will peak at the intersection of the perimeter line with the targeted utility.

LKO-1500 If the targeted utility line is alone and conducts a strong signal, it is recommended to enable **Compass line** to facilitate tracking (Section 4.6.2.4).

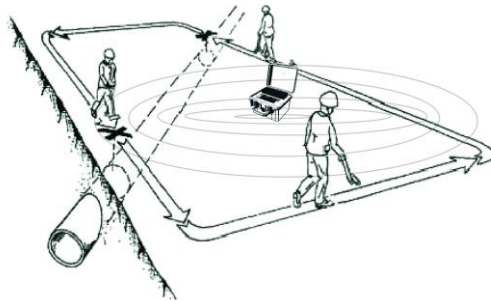

Fig. 32 Ground plot location with the Transmitter in inductive mode

4.7.2.2 Two-man test method

Set the Transmitter to 33k frequency option and set the optimum power.

Two operators should walk in parallel in the same direction while spaced 20 to 30 m. One of the operators should walk along the perimeter of the surveyed section while holding the Transmitter so that the transmitter antenna's centreline is pointing towards that operator. The other operator needs to walk along the opposite perimeter line while holding the locator and monitoring the variations on the bar graph (Fig. 33). The peak signal is detected when the locator is directly above the located utility.

LKO-1500 If the targeted utility line carries a strong signal, it is recommended to enable **Compass Line** to facilitate tracking (Section 4.6.2.4).

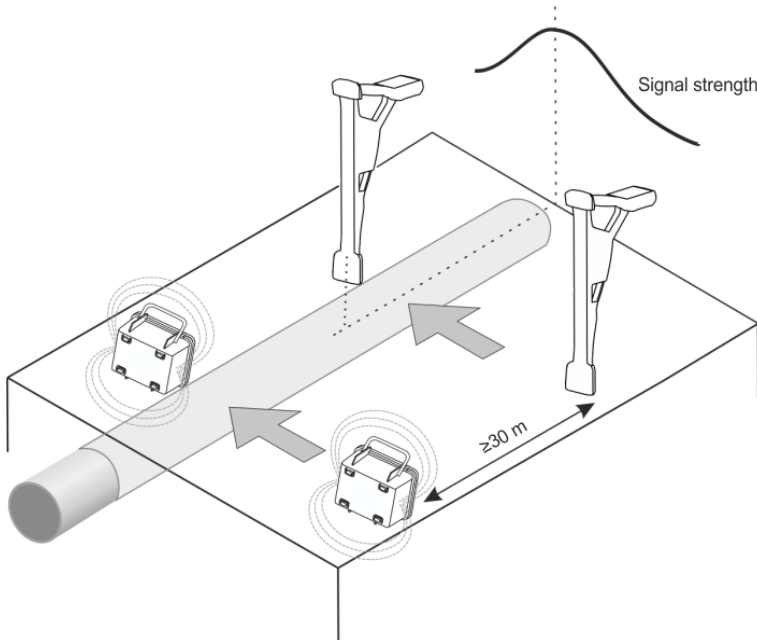

Fig. 33 Testing of ground plots without the LKN-1500 Transmitter

Repeat the survey in the same way, by moving in perpendicular to the previous direction.

5 Methods of locating damaged pipelines and utilities

The methods below are based on identification of relative distortions of signals within the damaged areas.

LKO-1500 Sometimes these distortions are unobservable so all the readings obtained during measurement shall be stored in the PC memory for further analysis (see sec. 6).

5.1 Fault finding with leakage current



This method should be used to locate broken insulation of pipelines or utilities with considerable leakage to ground. If a sudden drop of the current strength is revealed in the areas without tie-in connections and branches, this will mean that a considerable damage of the line insulation takes place. This method is true for high initial current ($\geq 0,5$ A) and considerable drop of current strength after the damaged area. We recommend you to make tracing on the frequencies of:

- **LKO-1500-LITE** 1024 Hz,
- **LKO-1500** 273 Hz or 526 Hz.

5.2 **LKO-1500** Fault finding with insulation control sensors – DKI-E or A-frame

Contact sensors of insulation control A-frame, and non-contact sensors DKI-E are used for location. Turn the Receiver into the “Trace-SENSOR” mode. The sensors shall be connected to the “SENSOR” jack (Pos. 4 in Fig. 7).

The broken areas are detected according to the strength of the signal from the sensors on the SENSOR scale. Verification of the utility position control shall be performed with the “peak” and “null” methods (See Fig. 13). If the **Compass** function is activated, locating will be performed by the position of the utility pointer relative to the Receiver (See Fig. 14). Always control the depth of the utility and the strength and direction of current to avoid false trials (the current direction shall be controlled when **two-frequency signal of 1024 Hz** is set on the transmitter).

To adjust the line scale of the signal strength from the insulation control sensors, set the pointer (Pos. 3 in Fig. 21 and Fig. 22) to the **SENSOR** position by pressing the  button. The gain may be selected with the gain up/down arrows. For the automatic gain selection use the  button.



NOTE!

Do not supply the voltage of more than 42 V to the SENSOR jack inputs.

5.2.1 Insulation fault finding by signal drop

A-frame – drive both A-frame sensors into the ground. **DKI-E probe** – two operators must walk about the surveyed area one behind another along the utility's centreline (Fig. 34). The beginning of the insulation fault point can be determined by:

- a rise of the signal strength when one of the sensors/one of the operators is directly above the fault location;
- with the null signal reading if the fault being pinpointed is between the A-frame sensors/the operators.

If the indications are partial to coming close to the fault location, narrow the spacing of the test points. Note that if the fault is extensive, there is a null (minimum) signal strength area between the signal peak readings. This null area can potentially be the location of a fault.

For a more precise and easy insulation fault location, you can use the SENSOR input signal polarity test. It is done by switching the Transmitter to generate the 1024 Hz double-frequency signal and the Receiver to 1024 Hz operating frequency on the SENSOR input. When the double-frequency signal strength reaches a predefined threshold, the signal polarity indicator comes on (item 6 in Fig. 21).

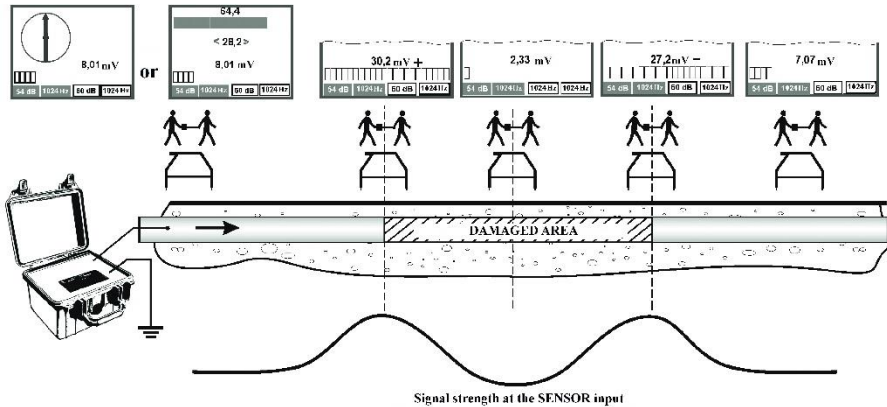

Fig. 34 Connection diagram and the signal strength when locating an insulation fault by detection of the signal loss at the polarity sign changeover

When the operator moves along the undamaged part of the utility, and then moves directly over the damaged area, the chaotic change (or missing) of polarity at the SENSOR input may occur because of weak signal (Fig. 34). As far as the operator approaches the bound of the damaged area, and the signal increases, the polarity becomes stable (plus or minus sign, depending on direction of current induction). When the operator passes the border of the damages area, the polarity will change (from "+" to "-" or vice versa). In case the insulation is damaged in one point only, the signal level over the damaged point will have a sharp null.

Keep in mind that the polarity inversion without a specific signal fluctuation may not be considered as a sign of fault.

5.2.2 The search of the insulation failure by the signal rise

The technique of search is the same for A-frame and DKI-E.

- **A-frame:** drive one of the sensors into the ground, and drive the other one next to the first one.
- **DKI-E probe:** one of the two operators should walk along the track at a steady pace. The other operator must follow the track at a distance from the trace centreline.

The insulation fault is located where the signal strength peaks (Fig. 35).

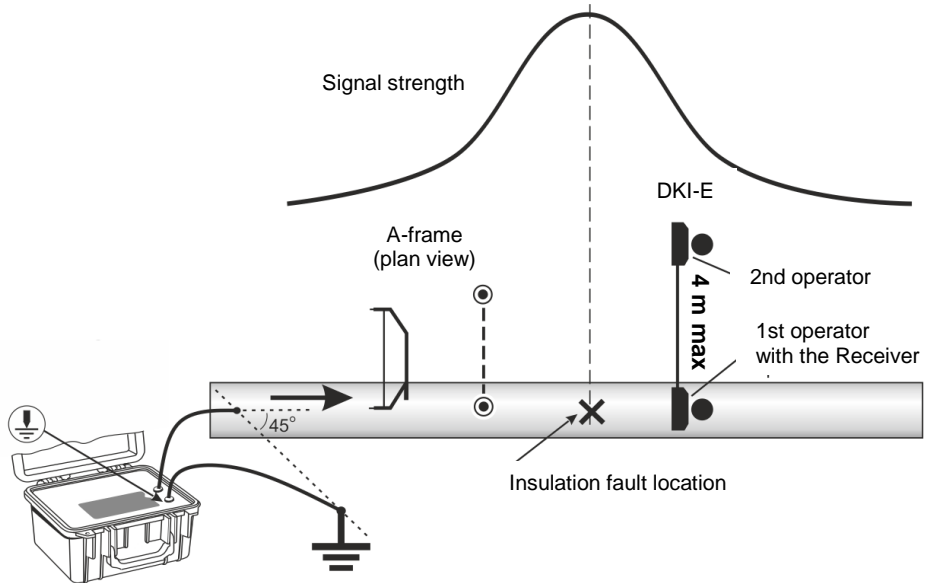

Fig. 35 Connection diagram and the signal strength when locating an insulation fault by detection of the signal rise

Using the “A-frame” provides more accurate readings from measurement to measurement, since the fixed distance between the pins eliminates signal fluctuation error caused by different distances. Measurements with this sensor, however, require the pins to be embedded into the soil, that may be inconvenient in some cases.

Keep the insulator surface of the **A-frame** clean. Soiling may cause signal drop or loss of sensitivity. When operation keep the insulator surface of the A-frame clean. Soiling may cause signal drop or loss of sensitivity.

DKI-E sensor accelerates tracing of single expanded utilities. The sensor operability does not depend on the type of soil or paving. The sensor, however, has lower sensitivity, particularly at low frequencies. Each operator holds a contact electrode of the sensor during operation. If tracing is performed close to the fault, the distance between the operators shall be reduced to clarify the position of cable failure.

5.2.3 Cable breakdown location

Keep in mind that the ferromagnetic shield over the cable conductor may reduce the detected signal strength so the search shall be made at maximum possible current.

5.2.3.1 Finding of short-circuited conductors

Fig. 36 shows the diagram of tracing the short-circuited cables. The Receiver LKO shall be brought along the target utility, and the signal strength shall be controlled on the peak scale. The signal strength may change before the shorted area depending to the cable lay pitch. The signal fluctuation stops behind the short-circuited area, and signal strength may drop (case 1) or rise (case 2). In the first case, the dead short takes place, when only the cable conductors are shorted. In the second case, the cable conductors are shorted to each other and to the shield.

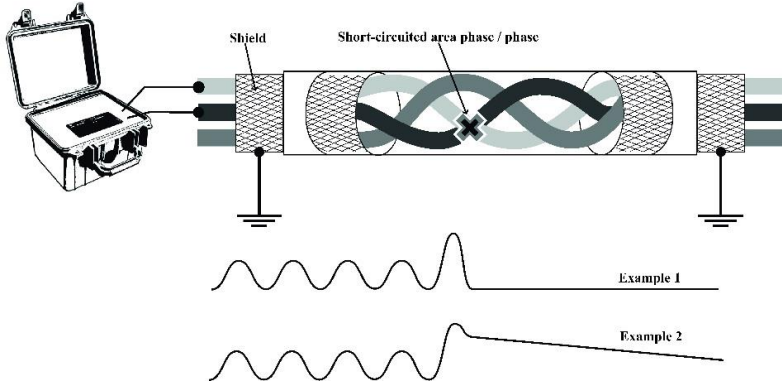

Fig. 36 Layout and signal diagram at the method of search of short-circuited wires

5.2.3.2 **LKO-1500** Location of shorted conductor-shield positions

The layout of location of conductor-shield shorted area is shown in Fig. 37 (phase A). The signal strength may change before the shorted area depending to the cable lay pitch. The signal fluctuation behind the short-circuited area remains the same, and signal strength rise abruptly.

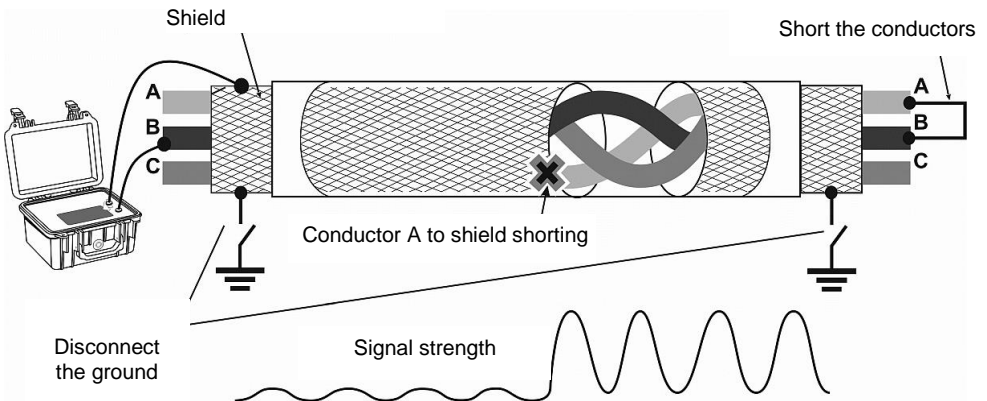

Fig. 37 Layout and signal strength of tracing of conductor– armor short-circuit

5.2.3.3 LKO-1500 Tracing of damaged insulation and grounding area

Cable insulation failure relative to the ground with the resistance of hundreds Ohm may be located with insulation control sensors – A-frame/DKI-E. Connect the Transmitter in accordance with **Fig. 38**. The grounding wire shall be connected to the Transmitter jack with the \perp marking. The methods of locating are generally the same as those described in sec. 5.2.1 and 5.2.2.

In case the cable insulation resistance relative to the ground does not allow the use of the insulation control, the method of phase tracing may be applied. It is optimum when the earth leakage impedance can be up to 0.5 M Ω .

The area of damaged insulation shall be determined initially with a reflection-coefficient meter. One operator only locates by this method, and no additional sensors are required.

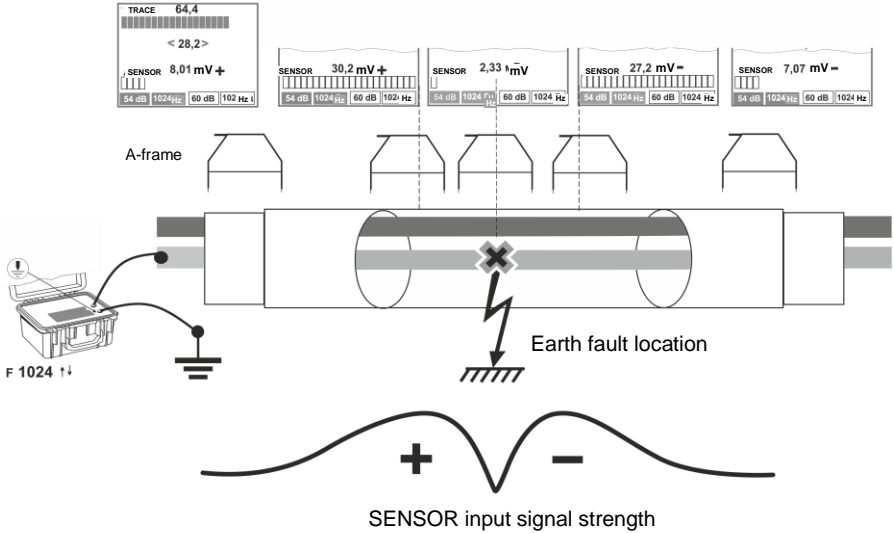

Fig. 38 Connecting diagram and signal strength for the method of insulation damage tracing with insulation control

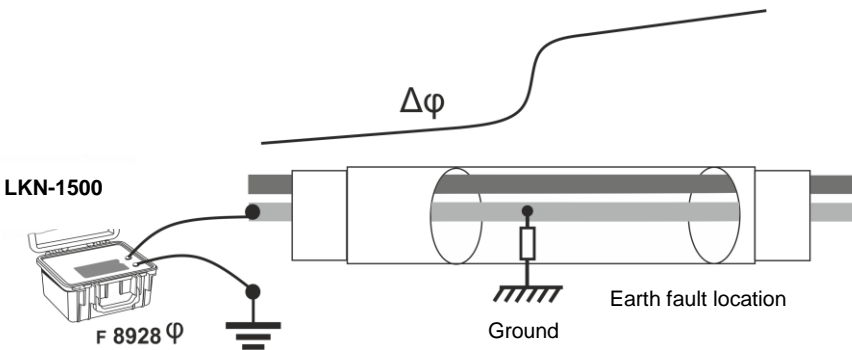



Fig. 39 Connecting diagram and phase shift at the phase method of cable insulation failure locating

Connect one lead of the Transmitter to a damaged conductor (See **Fig. 39**); the opposite end shall be protected. The second lead of the Transmitter shall be grounded with a pin placed at the distance of no less than 5 m. from the cable. Preset the double frequency Φ . Select the **Trace** mode and frequency of the Φ **8928** on the Receiver. Stand directly over the utility line at the beginning of the tested plot. Make sure that you are not closer than 20 m to the point of connection of the Transmitter.

Press the  button on the Receiver to reset the phase indications. Move along the target line, directly over it, and control the position with the null scale; take phase readings carefully. The phase may change smoothly. **The phase change rate will rise by several magnitudes with the polarity sign changing over where the insulation fault is located or directly downstream of it.** When the insulation fault is passed by, the phase readings will smoothly vary at a low rate.

The flaws of this method are as follows:

- phase fluctuation within the areas of damaged insulation is less obvious than signal fluctuation by the insulation control sensor tracing method for example A-frame,
- interferences from adjacent utilities.

6 Data storage, GPS navigation

The Receiver stores the measured data in the non-volatile memory, including position from external GPS module. Connection to the external GPS module is wireless.

The following parameters may be stored in the Receiver memory both with GPS coordinates and without them:

- strength of signals from magnetic antennas and at the SENSOR input (see sec. 4.6.2);
- direction to utility line (see sec. 4.6.2.1);
- depth of utility and current flowing through it (see sec. 4.6.3);
- direction of tracing current (see sec. 4.6.2.5);
- relative polarity at the "SENSOR" input (see sec. 5.2);
- signal phase at the "Trace" input (see sec. 5.2.3.3);
- operating frequencies,
- local time and date at the moment of readings through GPS,
- target point coordinates obtained through the GPS.

Precise co-ordinate position depends on such factors as quantity of satellites within the direct visibility, satellite arrangement, reflected signals, if any, influence of ionosphere, satellites chronometer errors and technical characteristics of the GPS module.



- With dedicated GPS transmitters, **the accuracy can be improved to 1 cm.**
- The manufacturer warrants proper performance of the LKO Transmitter if interfaced with these GPS module types: GT-750, Holux M1000, or RCV3000.
- If a wired GPS receiver is used which provides a high accuracy of readings, it is essential for the device to output data compliant with the NMEA-0183 RMC and GGA formats and a 1 Hz refresh rate.

6.1 Adjustment of the Receiver to the GPS modules

The GPS module shall be placed very close to the Receiver, e.g. in the pocket of the sunscreen cover (Fig. 8).

Before you start operation, match the Receiver with the GPS module. In **Menu** select **GPS > Connection to GPS > PIN code**. Set the PIN code of the GPS module (these are more commonly used codes: "0000" or "1234"). In you use other codes that consist of four randomly selected digits, enter the digits by pressing the gain up/down buttons.

Then switch the GPS module on. In **Menu** select **GPS > Connection to GPS > Search of Connection to GPS**. On completing the search, select the desirable GPS module from the list of available modules by pressing the gain up/down buttons. Confirm selected item by pressing the  button.

Connection to the selected GPS module will be performed through the **Menu > GPS > Connection to GPS > Switch on** options or automatically on selection of the track number (see sec. 6.2).

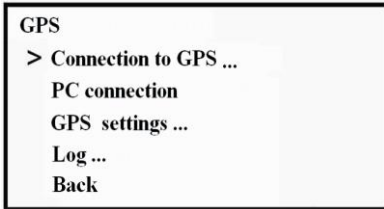

Fig. 40 GPS settings display

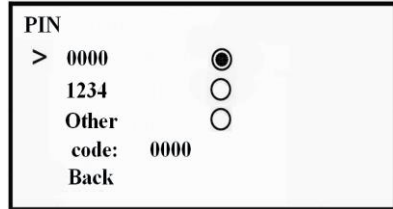







Fig. 41 GPS PIN settings display

The name and address of the GPS module, quantity of detected satellites and defined coordinates and time are available through the **MENU > GPS > Connection to GPS > Information** options. Status of access to GPS module is displayed in the Receiver with symbols (p. 15 Fig. 21).

Tab. 4 Status of access to GPS module

No.	Icon	Description
1.		No access to the GPS module
2.	 yellow	Connection to the GPS module is establishing Wait for a minute
3.	 yellow	Connection to the GPS module has been established GPS coordinates are missing (cold start of the GPS module, poor conditions of GPS signal processing)
4.	 green	Connection to the GPS module has been established Coordinates under processing
5.	 red	Lost connection to GPS module

The cold start period (e.g. first start after long-term idling of the GPS module) depends on the GPS model and quantity of available satellites, and it may last up to 20 minutes. At that, the  icon will be shown in yellow. With the next start of the module establishing the connection to the satellites will not exceed a few seconds.

6.2 Track recording

Press the  button after you switched the Receiver on. You will go to the following menu options: **MENU > GPS > GPS Settings > Save the track as...** You shall decide if you create a new track or continue recording to the existing one. After that, the Receiver will establish communication with the GPS module

Obtained data may be recorded both by pressing the  button and automatically at the preset intervals (auto tracking).





At the moment of recording, the  icon will be displayed (see pos. 16 in **Fig. 22**). The icon will be **green** if the stored point has GPS coordinates or it will be **red** if the stored point has no coordinate position.



Fig. 42 Track recording display



6.2.1 Recording with button

When you press the  button, the information displayed at the moment of pressing will be stored in the selected track. In the **LKZ Terminal** program you may view the stored data. At that, the recorded point will be tagged with the  in the **Tag** field.

The individual locations can be marked with **dedicated tags**, e.g. to mark the areas of supposed insulation failure or utility branch. To do so, press the  button and hold it pressed for 2 seconds. The audible signal will be heard continuously. When you view the stored data through the **LKZ Terminal** program you will see this point marked with ! in the **Tag** field.

6.2.2 Auto tracking

The Receiver can automatically store data in a track file. The data is written at predefined time intervals (which can be set from 1 to 60 s). The time interval can be set in **Menu > GPS > GPS Settings > Autotracking**. You can start and stop the au-

tomatic writing of the track file by pressing . If the automatic writing is stopped, the display shows the  icon. This mode also permits writing of the **dedicated tags**. You can do this by pressing and holding  for 2 seconds (until a long beep sounds off). When browsing the stored data in the **LKZ Terminal** software, the corresponding point will be marked with ! in the **Attachment** field.

The Receiver does not store the interval settings in the autonomous memory. They shall be set each time, if necessary, after the Receiver .

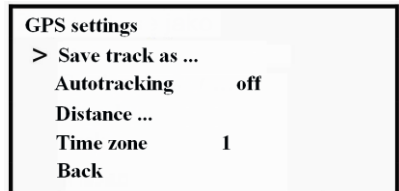



Fig. 43 Auto save selection display.



6.2.3 Log

The track list may be viewed through the **Menu > GPS > Log > Viewing** options. The information on number, date, time of the first stored point and quantity of points in the track, if any, may be viewed for each track. Track selection may be done by the buttons of gain up/down. Track may be deleted

with the  button. With the  button you may confirm the current track for data storage, exit from menu and start communication with the GPS module.

6.2.4 Distance

The receiver calculates and displays on the screen passed distance, basing on the obtained GPS coordinates from an external unit (p. 20 **Fig. 20**):

- as the distance of a straight run from the last point marked by pressing the button  to the current location;
- as the sum of the altogether distances between the points registered by pressing  from the very first and the distance between the last registered point and the current location. It allows display sprightly passed distances and also the distances consisting of broken lines.

For this, each time you are changing direction, press the button .

You can choose the proper option in the **Menu > GPS > GPS settings > Distance**. The distance is not stored in the autonomous memory – it is set to zero at every turning on the receiver.

6.2.5 Transmission to PC

The LKO Receiver can only output data to a PC over a WiFi connection. PC operating system requirements are: Windows (XP SP2/SP3, Vista, 7, 8, 10). To connect to a PC, the PC must have a WiFi interface board installed or an external WiFi USB dongle connected. The PC must be within 8 metres from the Receiver. Data communication is facilitated by the operational system of the PC. Information is transmitted from the Receiver memory to the PC as files with tracks.

The special-purpose program **LKZ Terminal** is used to facilitate data processing. This program is designed to receive the tracks from the Receiver, save the tracks in the PC memory, edit the tracks, plot graphs for insulation condition analysis, etc. The program and its manual are available for downloading on the manufacturer's website.

In order to transmit data to the PC proceed as follows:

- start the **LKZ Terminal** program on the PC,
- select connection to the PC in the Receiver menu: **Menu > GPS > PC connection**,
- select **Load track form Receiver** option from the menu of the **LKZ Terminal** program to read the track from the Receiver,
- in the **Track selection** window choose the desired track from the track list and confirm with **OK**. Wait until the track reading is complete.

With this program you may superimpose the tracks onto the maps of the "Yandex Maps" and "OpenStreetMap". In this case you shall have Internet connection. If the Internet access is via the proxy-server, you shall adjust the parameters through the **LKZ Terminal** program settings. In case of poor connection to the network, the map will not be displayed; the other functions will be available.

7 Power supply

7.1 LKN-1500 power supply

Accumulator shall be charged when the transmitter is switched off for longer time. Following these guidelines will improve the battery life.



- It is required minimum 8 hours to charge empty accumulator. Charging time period shall be increased to 12 hours to reach full capacity of accumulator.
- For extended life time of accumulators you shall:
 - charge accumulator at a temperature from +10 to +30°C,
 - limit the "depth" of discharging (do not allow to discharge completely),
 - charge accumulator straight after discharge.
- Store the transmitter at a temperature from -15 to +30°C and recharge accumulator once in 3 months.

To charge the battery, connect the power supply plug to the 12 V socket of the transmitter (see pos. 2 in Fig. 2). Power supply unit shall be connected to 230 V mains. The battery charging process is shown as a scrolling icon ► (See p. 17 in Fig. 2). When the battery is fully charged, the icons are continuous still and the display is periodically illuminated.

After charging is complete disconnect power supply unit from 230 V mains and then from the transmitter.

7.2 LKO-1500-LITE / LKO-1500 power supply

The batteries may be replaced without breaking a seal. The Receiver is powered by a battery pack. The battery pack can be replaced with 5 disposable or rechargeable AA batteries.

The replacement batteries need to be installed in a dedicated box, which is to be installed in the original battery compartment and wired to the device. Power supply voltage is from 7.5 V to 5.2 V.

The Receiver has a battery level indicator, and it goes off automatically to avoid excessive discharge when the battery is low. The Receiver is switched to a battery charging mode when the power supply unit is connected. The Receiver secures the battery against overcharge.



NOTE!

- Before charging, make sure that a rechargeable battery is put into the battery compartment. If the battery case contains non-rechargeable batteries when charging, this may cause damage to the receiver.
- The ambient temperature shall be from plus 10°C to plus 30°C when charging. Charging at other temperatures may reduce battery life.

Recharge the battery pack by plugging the charger to the respective charging port of the Receiver (item 1 in Fig. 7). Plug the power charger to a 230 V outlet. The battery pack charging process is indicated on the display by filling out the battery icon in black (). When the battery pack is fully charged, the battery icon is fully black. If completely drained, the battery pack will take **6 to 8 hours** to recharge.

During prolonged storage of the Receiver, it is recommended to recharge the battery pack every three months.



- If the battery pack has been completely drained, the battery icon may take some time to appear on the display.
- Charging of standard battery is with the current from 400 mA to 500 mA. When charging the batteries with other rated capacity, always check the temperature. If it rises quickly, stop charging.

8 Possible faults and troubleshooting

The possible faults and remedies are listed in tables below.

8.1 LKO-1500 transmitter

Tab. 5 Potential failures of LKN

Type of failure	Possible cause	Remedial procedure
Transmitter start failure or accidental shutdown	Discharging accumulator	Charge accumulator
	Accumulator failure	Replace accumulator at the authorized Sonel service.
Accumulator fails to charge within a given period	Accumulator failure	Replace accumulator at the authorized Sonel service.
	Power supply unit failure	Check power supply unit

8.2 LKO-1500-LITE / LKO-1500 receiver

Tab. 6 Potential failures of LKO

Fault	Possible cause	Remedies
The Receiver fails to be switched-on or it is switched off spontaneously	Battery is defective or discharged	Charge or replace batteries
<div style="background-color: red; color: white; padding: 2px; display: inline-block; margin-bottom: 5px;">LKO-1500</div> The battery pack charging process is not displayed (the battery pack is not being charged).	Power supply module failure.	Inspect the power supply module.
	Battery pack failure.	Servicing by the manufacturer is required. (Battery pack replacement).
	The battery pack has been deeply drained.	Charge the battery pack for at least 4 hours.
When power supply is on the Receiver fails to respond to the Transmitter signal	No contact in antenna plug connector	Repair or replace the headphones.
	The headphones show evidence of cracking.	Repair or replace the headphones.
The headphones fail to deliver sound whereas the sound is good through the internal speakers	Break in headphone circuit	Repair or replace headphones

9 Maintenance and running repairs

The service of LKZ-1500 Transmitter and Receiver is about following the rules of operation, storage, charging of batteries, routine check and troubleshooting recommended by SONEL S.A.

Repair and also replacement of the rechargeable battery or batteries, is allowed only at the manufacturer factory, or in special repair shops. Damage to the seals results in the loss of warranty for the device.

The case of the set, can be cleaned with a soft, damp cloth using generally available detergents. Do not use any solvents or cleaning agents that could scratch the housing (powders, pastes, etc.).

Cables can be cleaned with detergent water and then wiped dry.

10 Transportation and storage

Shipment of the Receiver shall be performed in a standard package by any type of vehicles. When the Device is delivered by plane, it shall be put into a heated hermetical compartment.

The Receiver shall be shipped and stored under the following conditions:

- ambient temperature: from minus 50°C to +70°C;
- relative humidity of 90 % max at the temperature of +30°C;
- The impact of precipitation is not allowed.

Please note the following when storing the set:

- disconnect all wires from the transmitter,
- thoroughly clean the transmitter, receiver and all accessories, For extended periods of time, remove the batteries or accumulators from the receiver,
- to avoid full discharge of the battery in the transmitter, with long storage, it should be recharged from time to time.

11 Dismantling and utilization

The Receiver utilization shall be performed by the customer in accordance with the rules and procedures adopted on the territory of the customer's country. The device does not contain the ecologically hazardous elements. Keep in mind that:

- Waste electrical and electronic equipment should be collected selectively, i.e. not with other types of waste;
- Waste electronics should be disposed of at a collection point in accordance with the law on waste electrical and electronic equipment or in accordance with local law;
- Before disposing of equipment to a collection point, do not disassemble any part of this equipment yourself;
- Observe the local waste disposal regulations for used batteries and accumulators.

12 Technical data

The device does not have the character of a standard and therefore is not subject to calibration. The proper form of control for this type of instrument is checking.

12.1 LKN-1500 transmitter

12.1.1 Basic technical data

Parameter		Value	Notes
Output signal frequency	single-frequency	273 526 1024 8928 32768 (33 kHz)	± 2 [Hz]
	double-frequency (basic frequency)	1024 ($\uparrow\downarrow$) 8928 (φ)	-
Power output setting range, W		from 1 to 10	In steps 1, 2, 5 and 10 [W]
Voltage output, max, V	without limitation	200	transmitter maximum voltage output is 130 V at a frequency of 32768 Hz;
	with limitations	30	-
Accuracy of output voltage		\pm (5% m.v. + 5 digits)	transmitter accuracy is not rated at frequencies of 8928 and 32768 Hz.
Load conditioning range at maximum power output on frequencies, Ohm	273, 1024 [Hz]	from 30 to 3000	-
	8928 [Hz]	from 30 to 2000	-
	double-frequency		-
Output current, no more than [A]		0.6	-
Current output indication accuracy		\pm (5% m.v. + 3 digits)	transmitter accuracy is not rated at frequencies of 8928 and 32768 Hz.
DC power supply range, V		from 10,5 to 15,0	-
Power consumption if using 12 V external power supply, max., [W]		22	-
Continuous, Pulse operation mode at maximum power output in normal conditions on fully charged internal accumulator, hrs, minimum		6	In pulse mode at maximum output power
Insulation strength between "Output" sockets and enclosure in normal conditions, alternate current at a frequency of 50 Hz, V		1500	Alternating current of frequency 50 [Hz]
Insulation resistance between "Output" sockets and enclosure (voltage 2500 V) in normal conditions, minimum, M Ω		20	At the voltage 2500 [V]

Notes:

m.v. – measured value

digits – last digit weight

12.1.2 Other technical data

- a) level of protection according to EN 60529 IP 54 (IP53 For open casing)
- b) power supply VRLA (AMG) lead-acid 12 V, 7 Ah
- c) dimensions 275 x 250 x 180 mm
- d) weight about. 4,9 kg
- e) operating temperature -20...+55°C
- f) storage temperature -50...+70°C
- g) fiducial temperature +23 ± 2°C
- h) relative humidity no more than 90% at the temperature of +30 °C
- i) atmospheric pressure from 840 to 1067 hPa



The transmitter can produce interferences which exceed its allowable values specified in EN 61326-1 and in the case of signaling on the mains power supply, it may cause interference to other equipment as it follows from its operating principle.

12.2 LKO-1500-LITE / LKO-1500 receiver

12.2.1 Basic technical data

Parameter	LKO-1500-LITE		LKO-1500	
	Frequency [Hz]	Min. sensitivity [µA/m]*	Frequency [Hz]	Min. sensitivity [µA/m]*
Nominal frequency values during operation with the Transmitter and the frequency-specific Receiver sensitivity.	1024 8928 32768 (33k)	150 25 5	273 526 1024 8928 32768 (33k)	500 300 150 25 5
Passive operating frequencies [Hz]	50, RADIO, SB		50, 100, 300, 550, 1450, RADIO, SB	
Bandwidth in RADIO mode [kHz]	10 to 36		10 to 36	
Bandwidth in SB mode [Hz]	48 to 14000		48 to 14000	
Additional operating frequencies during operation with third-party generators	-		491, 512, 982, 2000, 2048, 8440, 9828, 10000	
Nominal frequency values during operation without the Transmitter [Hz]	-		25, 50, 60, 100, 300, 550, 1450	
Operating frequency in PROBE mode [Hz]	-		-	
Min. dynamic response range of input signals [dB]	102		102	
Max. bandwidth for specific operating frequencies [Hz]	at -3 [dB]	at -60 [dB]	at -3 [dB]	at -60 [dB]
	9	24	9	24
Utility feature depth measurement [m]	0.10 to 6.00		0.10 to 10.00	

Parameter	LKO-1500-LITE	LKO-1500
Line current measurement at operating frequency	10 mA to 10.0 A	10 mA to 10.0 A
Max. depth indication error for single, expanded, and direct communication	$\pm\{[4+0.3h(h+1)]\%+0.1\text{ m}\}$, with h – measured depth	$\pm\{[4+0.2h(h+1)]\%+0.1\text{ m}\}$, with h – measured depth
Location accuracy for a 2 m deep single utility	$\pm 0.1\text{ m}$	-
SENSOR input voltage measurement range at operating frequency	-	0.01 mV to 1.70 V
Maximum error limit of voltage measurement	-	$\pm(3\% \text{ m.v.} + 3 \text{ digits})$
SENSOR input sensitivity at 6 dB SNR, min. value [mV]	-	0.05
SENSOR input resistance [M Ω]	-	1
Max input power [W]	-	2
Min. continuous operating time at full battery pack charge in normal conditions [h]	5	5

* Rated for the "Broad peak" method. The signal-noise ratio is 6 dB.

The Receiver provides signal gain adjustment with the step of 6 dB (each step provides doubled gain).

12.2.2 Other technical data

- a) level of protection according to EN 60529 IP54
- b) power supply nickel-metal hydride batteries Ni-Mh 6 V/2000 mAh
- c) dimensions 700 x 300 x 140 mm
- d) weight
 - LKO-1500-LITE ca. 1.7 kg
 - LKO-1500 ca. 1.8 kg
- e) operating temperature -20...+55°C
- f) storage temperature -50...+70°C
- g) relative humidity max. 95% at +30°C
- h) atmospheric pressure from 600 to 1067 hPa
- i) fiducial temperature +23 \pm 2°C

13 Accessories

The current list of accessories can be found on the manufacturer's website.

13.1 Standard accessories

The standard set of equipment supplied by the manufacturer includes

Name	LKZ-1500-LITE LKZ-1500	LKN-1500	LKO-1500-LITE LKO-1500
• LKN-1500 transmitter	√	√	
• LKO-1500-LITE / LKO-1500 receiver	√		√
• test lead 5 m, blue, 1 kV (banana plugs) WAPRZ005BUBB	√	√	
• test lead 5 m, red, 1 kV (banana plugs) WAPRZ005REBB	√	√	
• crocodile clip, blue, 1 kV, 20 A WAKROBU20K02	√	√	
• crocodile clip, red, 1 kV, 20 A WAKRORE20K02	√	√	
• ground probe 23 cm WASONG23	√	√	
• battery charger Z16 (transmitter) WAZASZ16	√	√	
• battery charger Z17 (receiver) WAZASZ17	√		√
• hanging strap WAPOZSZE6	LKZ-1500		LKO-1500
• bag L13 WAFUTL13	√		√
• sun-protecting cover for LKO-1500 WAPOZOSL4	LKZ-1500		LKO-1500
• accumulator NiMH 6 V, 2 Ah WAAKU23	√		√
• battery compartment WAPOJ3	√		√
• user manual	√	√	√

13.2 Optional accessories

It is possible to additionally purchase from the manufacturer and distributors the following elements, which are not included within the standard accessories:

- A-frame **WAADALKZRA2**
- DKI probe **WASONDKI**
- GPS module GT-750 **WAADAGT750**
- N-1 transmitting clamps ($\Phi=52$ mm) **WACEGN1BB**
- N-4 transmitting clamps ($\Phi=110$ mm) **WACEGN4**
- N-5 transmitting clamps ($\Phi=125$ mm) **WACEGN5**

14 Service

The manufacturer of the device provides all warranty and after-warranty repairs:

SONEL S.A.

Wokulskiego 11

58-100 Świdnica

Poland

tel. +48 74 858 38 60

fax +48 74 858 38 09

E-mail: export@sonel.pl

Web page: www.sonel.pl

15 Laboratory services

SONEL Testing and Calibration Laboratory has been accredited by the Polish Center for Accreditation (PCA) – certificate no. AP 173.

Laboratory offers calibration for the following instruments that are used for measuring electrical and non-electrical parameters.



AP 173

• METERS FOR MEASUREMENTS OF ELECTRICAL PARAMETERS

- voltage meters,
- current meters (including clamp meters),
- resistance meters,
- insulation resistance meters,
- earth resistance and resistivity meters,
- RCD meters,
- short-circuit loop impedance meters,
- power quality analyzers,
- portable appliance testers (PAT),
- power meters,
- multimeters,
- multifunction meters covering the functions of the above-mentioned instruments,

• ELECTRICAL STANDARDS

- calibrators,
- resistance standards,

• METERS FOR MEASUREMENTS OF NON-ELECTRICAL PARAMETERS

- pyrometers,
- thermal imagers,
- luxmeters.

The Calibration Certificate is a document that presents a relation between the calibration standard of known accuracy and meter indications with associated measurement uncertainties. The calibration standards are normally traceable to the national standard held by the National Metrological Institute.

According to ILAC-G24 „Guidelines for determination of calibration intervals of measuring instruments”, SONEL S.A. recommends periodical metrological inspection of the instruments it manufactures no less frequently than once every 12 months.

For new instruments provided with the Calibration Certificate or Validation Certificate at the factory, re-calibration should be performed within 12 months from the date of purchase, however, no later than 24 months from the date of purchase.

ATTENTION !

The person performing the measurements should be absolutely sure about the efficiency of the device being used. Measurements made with an inefficient meter can contribute to an incorrect assessment of the effectiveness of health protection and even human life.

NOTES

NOTES



SONEL S.A.
Wokulskiego 11
58-100 Świdnica
Poland



+48 74 858 38 60
+48 74 858 38 00
fax +48 74 858 38 09

e-mail: export@sonel.pl
www.sonel.pl