

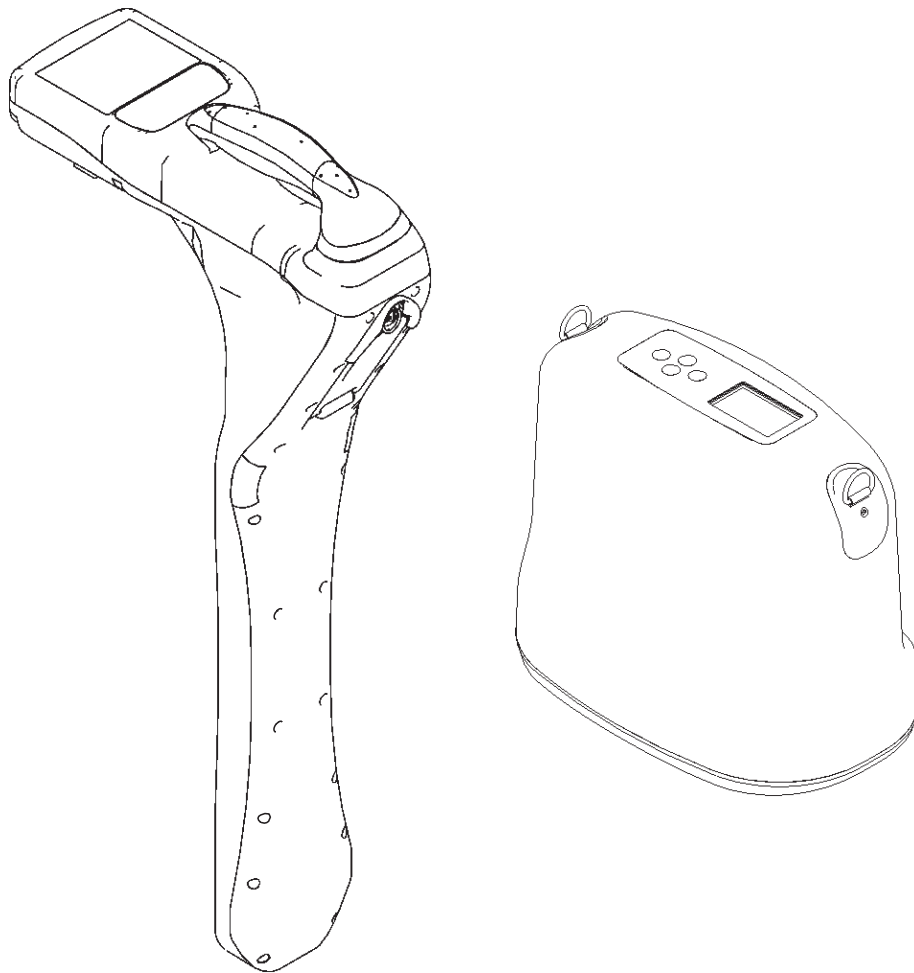

LKZ-2000

Operator's Manual



SONEL S.A.
Wokulskiego 11
58-100 Świdnica
Poland
tel. +48 74 858 38 60
fax +48 74 858 38 09
E-mail: export@sonel.pl
Web page: www.sonel.pl

Note:
Service repairs must be performed only by the manufacturer.

Overview

Chapter Contents

| | |
|-------------------------------|----------|
| Serial Number Location | 4 |
| System Components | 5 |
| Intended Use | 6 |
| IEC Safety Definitions | 6 |
| About This Manual | 7 |
| Forward | 8 |

Serial Number Location

Record serial numbers and date of purchase in spaces provided.
 Unit serial number is located as shown.

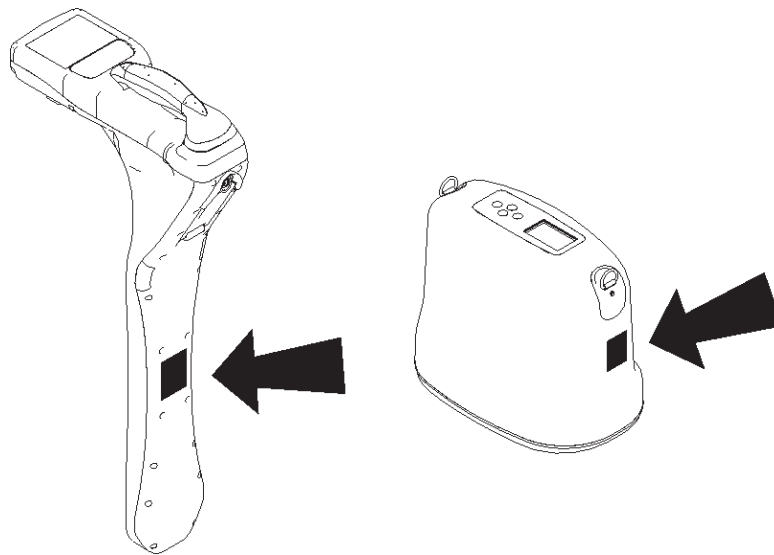

| Item |
|---------------------------------|
| Date of purchase |
| Receiver serial number |
| Transmitter serial number |
| Fault finder serial number |
| Accessory model & serial number |
| Accessory model & serial number |

System Components

Receiver LKO-2000

| Model | Standard Features |
|----------|---|
| LKO-2000 | Receiver: 70+ frequencies, configuration software, radio transmitter, RX/TX communication, Ambient Noise function |

Transmitter LKN-2000

| Model | Descriptions |
|----------|---|
| LKN-2000 | Transmitter: 12-Watt output, 70+ frequencies, configuration software, RX/TX communication |

Intended Use

The LKO-2000 receiver is designed to locate buried pipes and cables. Over 70 frequencies and four modes of operation are available to suit your specific locating needs.

The LKN-2000 transmitter places signals on target cables to be detected by LKO-2000 receiver. These units can be configured to send over 70 frequencies as well as custom frequencies.

The transmitter places a signal on the cable through either direct connection, induction clamping, or broadcast modes.

The system is designed for operation in temperatures typically experienced in earth moving and construction work environments.

Use in any other way is considered contrary to the intended use. The LKZ-2000 system should be operated only by persons familiar with its particular characteristics and acquainted with the relevant safety procedures. The system should be serviced only by SONEL S.A.

IEC Safety Definitions



Hazardous voltage-electrical shock or equipment damage can result if transmitter is connected to live cable. Have qualified utility personnel disconnect both ends of cable before working.



IEC protection class II or double insulated electrical device is one which has been designed in such a way that it does not require a safety connection to electrical ground. In a device of this class, no single failure can result in dangerous voltage becoming exposed so that it might cause an electrical shock. This characteristic must be achieved without relying on a grounded metal casing.

About This Manual

This manual contains information for the proper use of this equipment. Cross references such as 'See page 50' will direct you to detailed procedures.

Bulleed Lists

Bulleed lists provide helpful or important information or contain procedures that do not have to be performed in a specific order.

Numbered Lists

Numbered lists contain illustration callouts or list steps that must be performed in order.

Foreword

This manual is an important part of your equipment. It provides safety information and operation instructions to help you use and maintain your SONEL S.A. equipment.

Read this manual before using your equipment. Keep it with the equipment at all times for future reference.









If you sell your equipment, be sure to give this manual to the new owner.

If you need a replacement copy, contact your SONEL S.A. dealer. If you need assistance in locating a dealer, visit our website at www.sonel.pl.

The descriptions and specifications in this manual are subject to change without notice. SONEL S.A. reserves the right to improve equipment. Some product improvements may have taken place after this manual was published. For the latest information on SONEL S.A. equipment, see your SONEL S.A. dealer.

Thank you for buying and using SONEL S.A. equipment.

Contents

| | | |
|---|--|-----------|
|  | Overview Machine serial number, information about the type of work this machine is designed to perform, basic machine components, and how to use this manual | 3 |
|  | Foreword Part number, revision level, and publication date of this manual, and factory contact information | 8 |
|  | Safety Machine safety alerts and emergency procedures | 11 |
|  | Control Icons Control menus and display icon descriptions | 17 |
|  | Locate Procedures for locating active, passive and beacon signals | 25 |
|  | Service Service intervals and instructions for this machine | 45 |
|  | Specifications Machine specifications including weights, measurements and power rating | 49 |
|  | Support The warranty policy for this machine, and procedures for obtaining warranty consideration and training | 53 |
|  | Operating instructions for A-Frame | 55 |

Safety

Chapter Contents

| | |
|-------------------------------------|-----------|
| Guidelines | 12 |
| Safety Alert Classifications | 13 |
| Safety Alerts | 14 |

Guidelines

Follow these guidelines before operating any jobsite equipment:

- Complete proper training and read operator's manual before using equipment.
- Contact the appropriate utilities so they can determine the location of underground cables and pipes before any excavation. Classify the job site based on its hazards and use the safety equipment and work methods appropriate to the job site.
- Mark jobsite clearly and keep spectators away.
- Wear personal protective equipment.

Review jobsite hazards, safety and emergency procedures, and individual responsibilities with all personnel before work begins.

- Replace missing or damaged safety signs.
- Use equipment carefully. Stop operation and investigate anything that does not look or feel right.
- Contact your equipment dealer if you have any question about operation, maintenance, or equipment use.

Safety Alert Classifications

These classifications and the icons defined on the following pages work together to alert you to situations which could be harmful to you, jobsite bystanders or your equipment. When you see these words and icons in the book or on the unit, carefully read and follow all instructions.

YOUR SAFETY IS AT STAKE.

Watch for the three safety alert levels: **DANGER**, **WARNING** and **CAUTION**. Learn what each level means.

 **DANGER** indicates an imminently hazardous situation which, if not avoided, will result in death or serious injury.

 **WARNING** indicates a potentially hazardous situation which, if not avoided, could result in death or serious injury.

 **CAUTION** indicates a potentially hazardous situation which, if not avoided, may result in minor or moderate injury.

Watch for two other words:
NOTICE and **IMPORTANT**.

NOTICE can keep you from doing something that might damage the unit or someone's property. It can also alert you against unsafe practices.

IMPORTANT can help you do a better job or make your job easier in some way.

Safety Alerts

**⚠ DANGER**

Electric shock. Contacting electric lines will cause death or serious injury. Know location of lines and stay away.

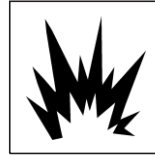
**⚠ WARNING**

Explosion possible. Serious injury or equipment damage could occur. Follow directions carefully.

**⚠ WARNING**

Jobsite hazards could cause death or serious injury. Use correct equipment and work methods. Use and maintain proper safety equipment.

**⚠ WARNING**

Incorrect procedures could result in death, injury, or property damage. Learn to use equipment correctly.

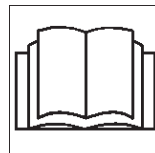
**⚠ WARNING**

Moving traffic - hazardous situation. Death or serious injury could result. Avoid moving vehicles, wear high visibility clothing, post appropriate warning signs.



Safety Alert

Read and follow all safety precautions.

Do not operate equipment unless you have completed proper training and have read the operator's manual.

Check that equipment is in good condition and that test leads are clean and have no cracked insulation.

Turn off transmitter when connecting or moving ground probe.

Jobsite hazards could cause death or serious injury. Use correct equipment and work methods. Use and maintain proper safety equipment.



WARNING

HIGH VOLTAGE. This device produces electric current that could cause death or serious injury. Electric shock may result if you touch the clips on the HV output cable. Use electrically insulating rubber gloves and proper procedures.



WARNING

Explosion possible. Do not operate transmitter near explosive devices or blasting operations.



DANGER

Electric shock or equipment damage can result if transmitter is connected to live cable. Have qualified utility personnel disconnect both ends of cable before working.



WARNING

Battery cells inside may vent or rupture. Do not crush, do not heat or incinerate, do not short circuit, do not dismantle, do not immerse in any liquid. Observe charging instructions.

Control Icons

Chapter Contents







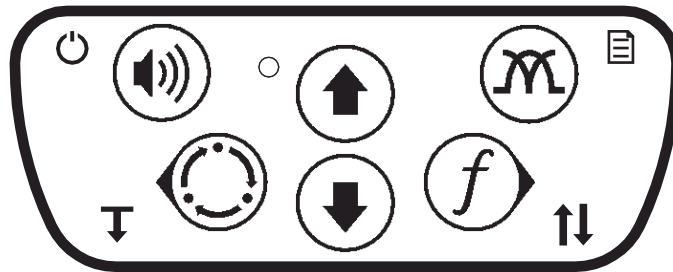





| | |
|--------------------|-----------|
| Receiver | 18 |
| Keypad | 18 |
| Display | 19 |
| Menus | 20 |
| Transmitter | 21 |
| Keypad | 21 |
| Display | 22 |
| Menus | 23 |

Receiver

Receiver Keypad









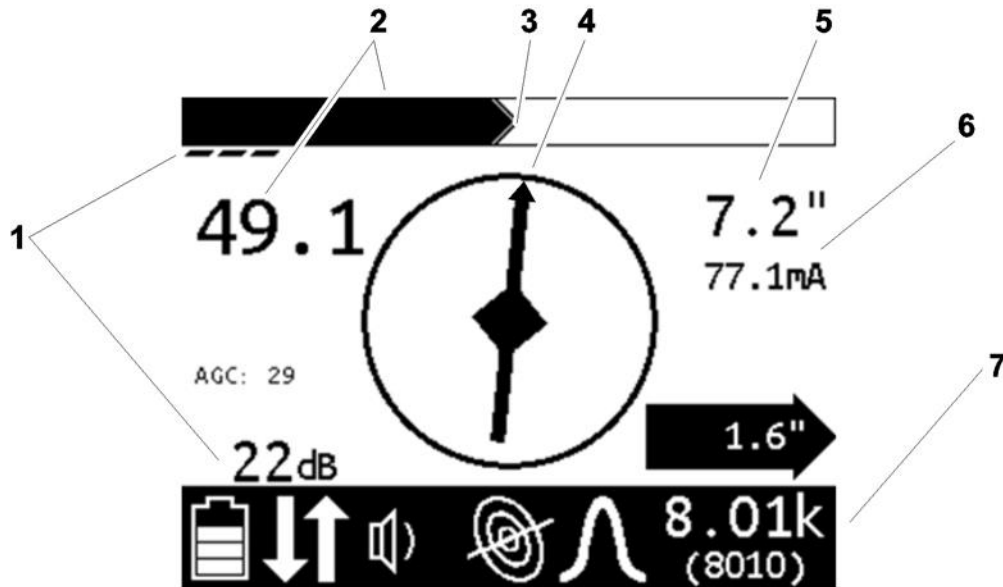





Keypad buttons perform several functions depending on operating mode. To activate most functions, press and release the button. For other functions, press and hold the button until the function activates.

| Receiver Keypad Icons | | |
|---|--|---|
|  Power ON/OFF (press and hold) |  Up |  Antenna Configuration |
|  Volume | |  Menu (press and hold) |
| Exit Menu |  Down |  Frequency |
|  Location Mode | |  Select / Next |
|  Back | |  Reset Direction Enable (press and hold) |
|  Depth (press and hold) | | |

Receiver Display























- 1. Gain
- 2. Signal strength
- 3. Peak signal
- 4. Compass
- 5. Estimated depth
- 6. Current meter
- 7. Unit status bar (see below)

| Status Bar Icons | | | | | |
|---|--|---|-------------|---|---------------------|
|  | Battery level |  | Line mode |  | Twin peak antenna |
|  | Direction enable feature active |  | Beacon mode |  | Null antenna |
|  | Volume level |  | Radio mode |  | Single peak antenna |
|  | No communication from transmitter |  | Power mode |  | Total field antenna |
|  | Frequency not available from transmitter | Selected frequency setting | | | |

Receiver Menus

Menus allow the operator to set user interface preferences. Use the up, down, select/next, and back buttons on the keypad to navigate the menu.



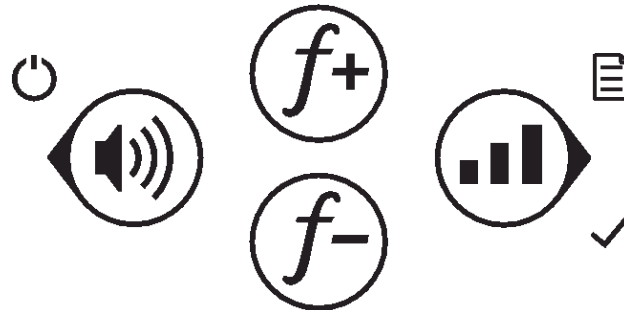

| Receiver Menu Icons | | | |
|---|---|----------------|---|
|  Frequency | Select frequencies to activate. | | |
| | Icons show which mode is suited for each frequency: | | |
| |  | Power | |
| |  | Beacon | |
| |  | Line | |
|  Settings |  | Language | Select user interface language |
| |  | Units | Select measurement units for distance and depth |
| |  | Backlight | Select backlight setting |
| |  | Shutdown Timer | Set amount of time before unit shuts off |
| |  | Communications | Select communication preference |
|  Options |  | Gain | Select gain option |
| |  | Autodepth | Select automatic or manual depth |
| |  | Offset Depth | Select offset depth setting |
| |  | Audio Mode | Select audio mode setting |
| |  | Audio Style | Select audio style setting |
|  System Information |  | System Info | Displays the receiver model configuration, model number, serial number, software version, hour count, configuration date, and calibration date. |
| |  | Diagnostics | Use to troubleshoot receiver. Contact Product support. |
|  Ambient Noise Measurement | Measures and displays noise at all frequencies in the selected mode. See “Measure Ambient Noise (Advanced Units)” on page 29. | | |

Transmitter

Transmitter Keypad



Keypad buttons perform several functions depending on operating mode. To activate most functions, press and release the button. For other functions, press and hold the button until the function activates.

| Transmitter Keypad Icons | | |
|--|--|---|
|  Power ON/OFF (press and hold) |  Frequency / Up |  Power output |
| Volume | | Select / Next |
|  Back |  Frequency / Down |  Menu (Press and hold) |

Transmitter

Transmitter Display

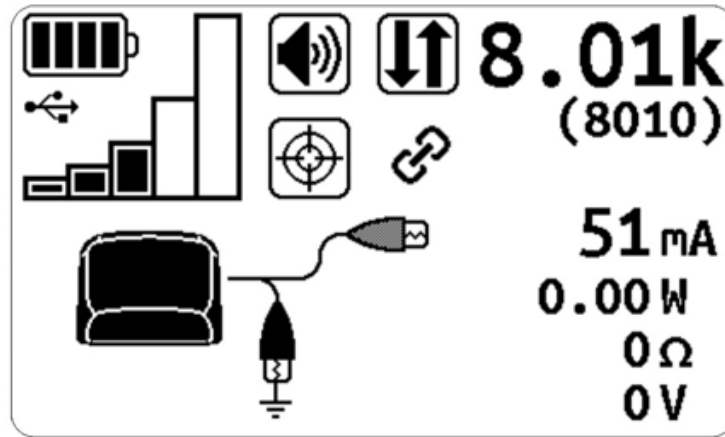

















The transmitter display shows the status of selected options as well as the active frequency and meter reading.

| Transmitter Display Icons | | |
|---------------------------|-------------------------|--------------------------------|
| Battery level | Volume on | Linked to receiver |
| External power | Volume off | |
| USB connected | Direction enable active | Inductive clamp connected |
| Output power level | Output active | Induction active |
| High power output enabled | Output interrupted | Direct-connect leads connected |

Transmitter Menus

Menus allow the operator to set user interface preferences. Use the up, down, select/next, and back keypad buttons to navigate the menu.

| Transmitter Menu Icons | | |
|--|---|--|
|  Settings |  Backlight | Select backlight setting |
| |  Output | Select output setting: |
| | |  Direction enable |
| | |  Dual output |
| | |  High power output |
| |  Meter | Select meter setting |
| |  Communications | Select communication preference |
|  Options |  Language | Select user interface language |
| |  Defaults | Restores unit to factory default settings |
|  Frequencies | Select frequencies to activate. | Icons show which connection can be used for each frequency: |
| | |  Induction |
| | |  Direct connect |
| | |  Induction clamp, standard |
| | |  Induction clamp, low frequency |
|  System Information | Displays the unit model configuration, model number, serial number, software version, hour count, configuration date, and calibration date. | |

Locate

Chapter Contents









| | |
|--|-----------|
| Prepare | 26 |
| Select Signal Mode | 26 |
| Select Antenna Configuration | 27 |
| Link Receiver to Transmitter (Advanced Units) | 27 |
| Select Locating Frequency | 28 |
| Adjust Receiver Gain | 29 |
| Locate Active Signals | 30 |
| Setup | 30 |
| Technique | 34 |
| Advanced Features | 35 |
| Locating cables with BIK probe | 38 |
| Locate Passive Signals | 39 |
| Setup | 39 |
| Technique | 39 |
| Locate Beacon Signals. | 41 |
| Setup | 41 |
| Technique | 41 |
| Common Signal Problems | 44 |



Prepare

Select Signal Mode





LKO-2000 receivers detect active and passive signals. Select the signal best suited for the locating jobsite. Depending on the receiver model, all modes might not be available.

| Signal Mode/Type | Description | Notes |
|--|---|--|
| Active Signals | Signal placed on a target line with a transmitter | |
|  Line signal |  Direct Connection | (preferred method) requires a connection directly to the target line |
| |  Clamp Induction | requires placing an optional induction clamp around the target line |
| |  Broadcast induction | sends current into lines near the transmitter |
|  Beacon signal | Signal transmitted from a beacon inside a pipe or conduit | Direct-connect leads connected |
| Passive Signals | Signal that a utility line picks up from the environment | |
|  Power Signal | Allows receiver to trace live 50 Hz or 60 Hz power cables | IMPORTANT: Current must be flowing through the cable |
|  Radio Signal | Allows receiver to trace cables that pick up and radiate very low frequency (VLF) radio waves | |



Select Antenna Configuration

Select the antenna configuration best suited for the locating jobsite.

| Antenna | Description | Advantage / Disadvantage |
|--|---|--|
|  Single Peak | Uses one horizontal antenna to detect signal. Response is highest at strongest signal. | more range / less precise |
|  Twin Peak | Uses two horizontal antenna to detect signal. Response is highest at strongest signal. | most precise / less range |
|  Null point | Uses a vertical antenna to detect signal. Search width is narrower than single peak. Response is lowest when receiver is over the line. | sharp response / easily distorted in congested areas |
|  Total Field | Uses a combination of two horizontal and one vertical antenna to locate signal. | easy to use when sweeping and eliminates ghost signals / easily distorted in congested areas |

Link Receiver to Transmitter (Advanced Units)

LKO-2000 receivers can be linked to LKN-2000 transmitters through a wireless connection. This allows the receiver operator to change transmitter settings through the receiver.

To link the receiver to a transmitter via Radio:

1. Navigate to **Settings>Communications** and select **Link**.
2. Select a device to link. Link is complete when the link icon is displayed.

IMPORTANT: Once linked, devices automatically connect when turned on. To unlink devices, navigate to **Settings>Communications** and select **Unlink**.

Select Frequency

The LKN-2000 transmitter can send signals in over 70 frequencies at 5 watt and 12 watt power levels. Likewise, the receiver can display information in over 70 frequencies. Use the LKZ-2000 Ambient Noise measurement application to determine suitable frequencies. Then, use the transmitter and receiver frequency menus to activate only the frequencies most suited for a particular jobsite. Be aware of these points:

- Lower frequencies travel farther than higher frequencies.
- Higher frequencies couple onto lines more easily.
- Higher frequencies also couple onto lines other than the target line more easily.

Activate Frequencies

To activate frequencies on the transmitter as well as the receiver:

1. Navigate to **Settings>Frequency** menu.
2. Select the frequencies best suited for the jobsite conditions.
When the box is checked, the frequency is active.
Note: Power, mode, and beacon icons indicate which mode a frequency is suited for.
3. While locating, press the **Frequency** button to toggle between activated frequencies.

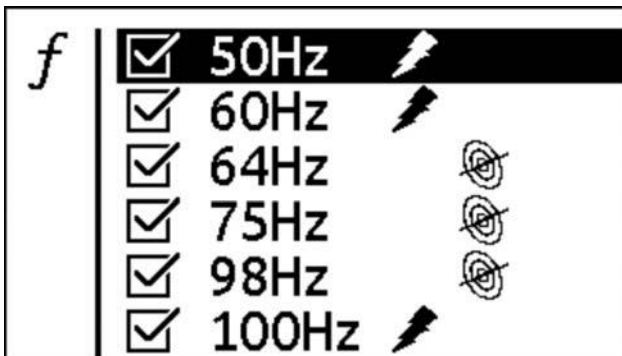

Measure Ambient Noise (Advanced Units)

The LKZ-2000 Ambient Noise application measures noise on the jobsite. For best locating, select a frequency with the least amount of noise. Noise levels are indicated numerically and graphically.

To measure ambient noise:

1. Ensure that transmitter output is turned off.
2. From the receiver menu, select the **Ambient Noise** function. The receiver will scan the surrounding area for noise on all frequencies enabled in the selected mode.



frequencies operating with the least amount of noise



frequencies operating with a large amount of noise

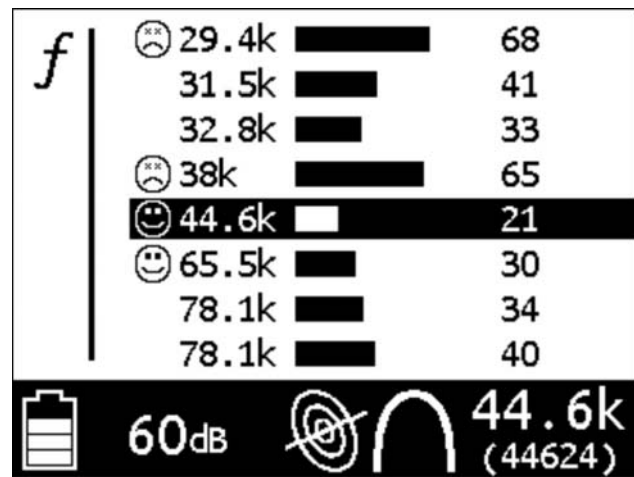

3. Highlight the desired frequency and press the Next button to exit the menu

IMPORTANT:

- If a line is connected to an active signal, the ambient noise measurement will be high.
- When a frequency is highlighted, a realtime noise is displayed.

Adjust Receiver Gain

The receiver gain setting controls the sensitivity to the signal.

| Action | Result | Effect |
|-----------------|--------------------------|---|
| increasing gain | more sensitive to signal | allows location farther away from signal source |
| decreasing gain | less sensitive to signal | stabilizes signal |

Locate Active Signals

Setup

Follow setup procedures for the type of locating you will be doing: direct connection, induction clamp, connecting to live power with live power adapter, or broadcast induction. For all types of active location that require leads, connect leads to transmitter at connector (2). Keep connector covered when not in use. When it is necessary to connect to external power, use connector (1).

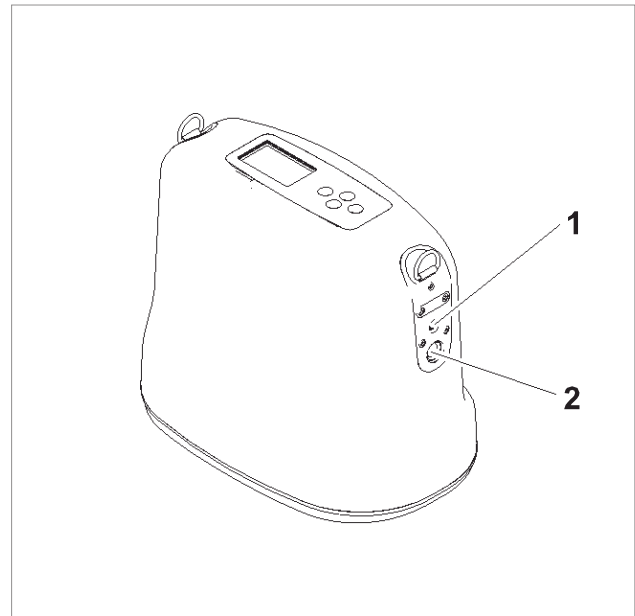

Induction Clamp



WARNING Jobsite hazards could cause death or serious injury. Use correct equipment and work methods. Use and maintain proper safety equipment.

NOTICE: Electric shock or equipment damage can result if transmitter is connected to live cable. Contact qualified utility personnel and follow all standards and requirements for disconnecting and grounding cables.

To set up transmitter for use with induction clamp:

1. Plug cable into transmitter.
2. Place clamp around cable.
3. Turn on transmitter.
4. Check battery level.

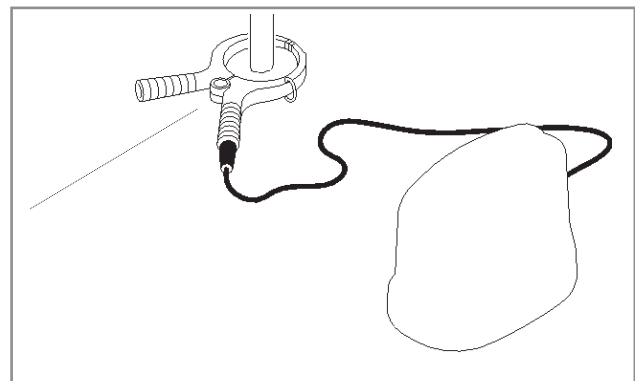



Direct Connection



WARNING Jobsite hazards could cause death or serious injury. Use correct equipment and work methods. Use and maintain proper safety equipment.

NOTICE:

- Electric shock or equipment damage can result if transmitter is connected to live cable. Contact qualified utility personnel and follow all standards and requirements for disconnecting and grounding cables.
- A built-in circuit breaker will automatically disable transmitter when leads are connected to a live cable. Display will flash and transmitter will beep. Turn off transmitter and disconnect from cable to reset breaker.

To set up transmitter for direct connection:

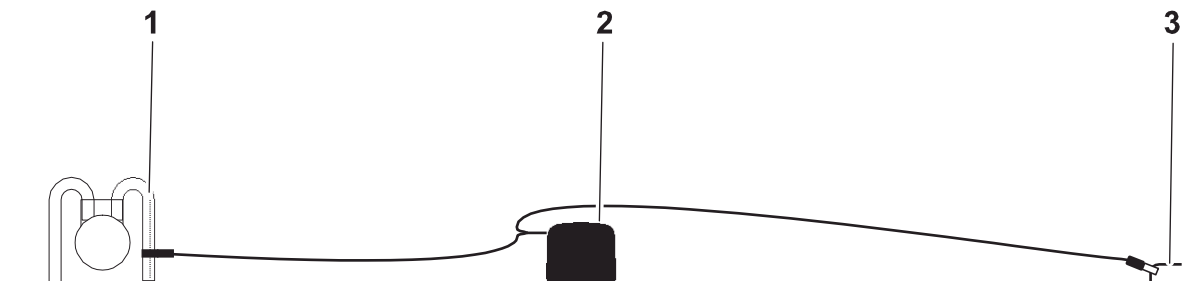

1. Carefully push ground stake (3) into ground.
2. Plug cable into transmitter (2).
3. Connect black lead to ground stake.
4. Connect red lead to cable (1).

Note: If using dual location, connect white lead to the additional cable to be located.

5. Turn on transmitter and check battery level.

NOTICE: Turn off transmitter when connecting or moving ground stake.

Connect with Live Power Adapter



WARNING Jobsite hazards could cause death or serious injury. Use correct equipment and work methods. Use and maintain proper safety equipment.

NOTICE:

- Do not operate equipment unless you are properly qualified to work on live power conductors.
- Use personal protective equipment rated for voltage and current of power conductor being connected to as defined by OSHA standards when using live power adapter.
- Do not connect to a conductor with a voltage greater than 480V.

To set up transmitter for use with live power adapter:

1. Verify that transmitter (1) is turned off.
2. Connect live power adapter (2) to the transmitter.
3. Connect live power adapter black lead to the ground stake (4).
4. Connect live power adapter red lead to live power conductor (3).
5. Turn on transmitter.
6. Select frequency greater than 8 kHz (29 kHz is preferred).
7. Adjust power level as needed.
8. Check battery level.

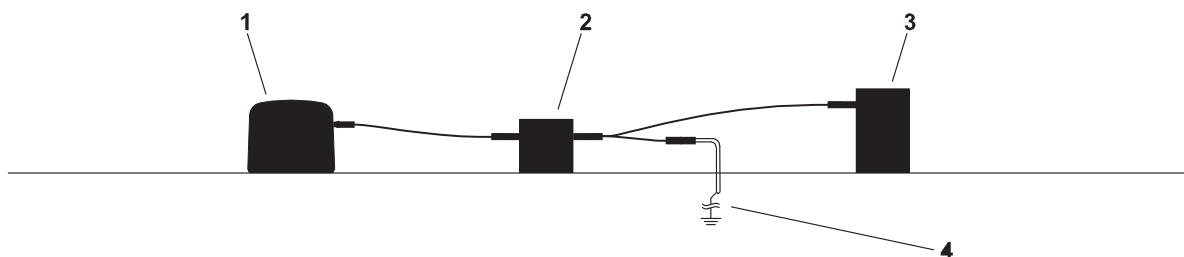

IMPORTANT: When finished locating the cable, turn off transmitter, disconnect live power adapter red lead from live power conductor, disconnect live power adapter black lead from ground stake, and disconnect live power adapter from transmitter.

Induction

To set up transmitter for induction:

1. Remove cable, stake, clamp and any other metal objects from transmitter.
2. Place transmitter parallel to and directly above suspected cable as shown.

NOTE: Transmitter must be parallel to object, as shown, in order to produce the best signal.

3. Turn on transmitter.
4. Check battery level.

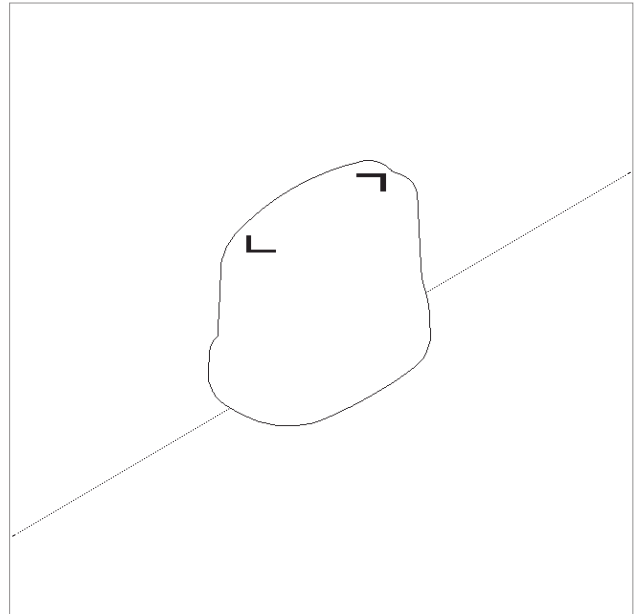

Technique

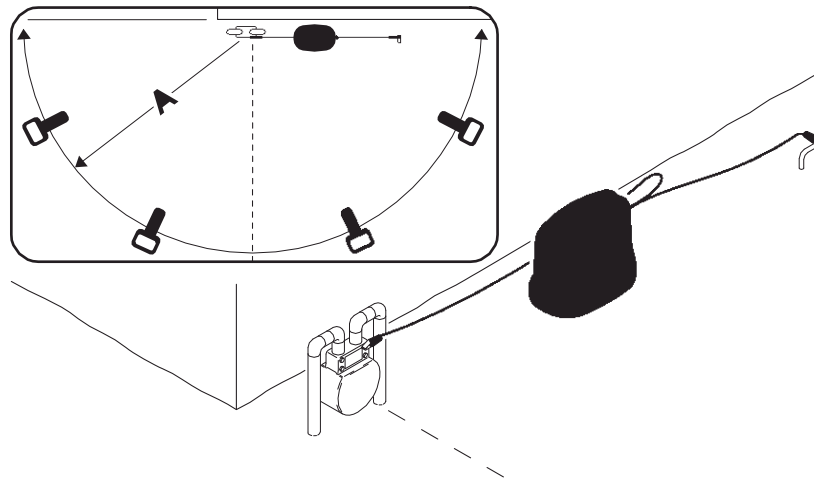

IMPORTANT: Follow steps below for all types of active location. For reference, the illustration above shows direct connection method. If using broadcast induction, ensure that transmitter is in line with and above suspected cable, as shown on previous page.

1. Facing away from the transmitter, walk in an arc approximately 25' (A, 7.5 m) around transmitter, as shown above.

2. Rotate the receiver and observe the screen:

- Target is located where signal response (1) is strongest. Signal strength is shown graphically as well as numerically.
- Adjust gain as needed to maintain signal strength. Gain is shown graphically as well as numerically (6).
- The Compass Line (2) shows the direction the cable runs.
- Move in the direction of the center arrows. When the arrows form a diamond (3), the target is located.
- AutoDepth reading (4) will appear when target is correctly located. If operating in Manual depth mode, press and hold the **Depth** button.
- Use Current Measurement (5) to identify target cable. Current on the target cable should be higher than current on another cable that is picking up signal inductively from target cable.

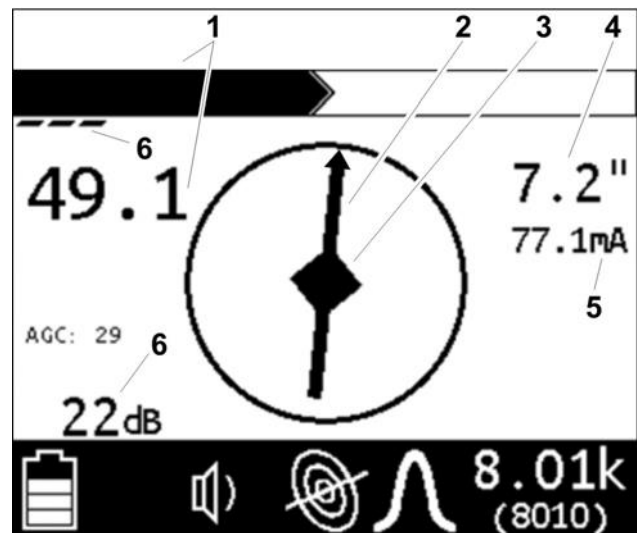

3. Continue to trace the cable and observe depth estimates every few paces.

4. Retrace the cable and mark with appropriate flags or paint.

Use Advanced Features

Direction Enable

Direction Enable allows the operator to set a reference for current flow on a target line. It is useful for maintaining line identity on jobsites where multiple utilities are present. Direction Enable is only available:

- in line location mode; and
- at frequencies of 10kHz and below.

To use Direction Enable:

1. On the transmitter menu, navigate to **Settings>Output>Direction Enabled** and select "Enable."
2. Ensure the function is available by looking for the Direction Enable icon (1) on the receiver.
3. Stand approximately 10 ft (3 m) from the transmitter with the receiver positioned so that the compass heading (3) is perpendicular to the target line. Face away from the transmitter.
4. Press and hold the Frequency button to set the direction of current flow. An arrow (2) will appear on the compass heading.
5. Continue locating.

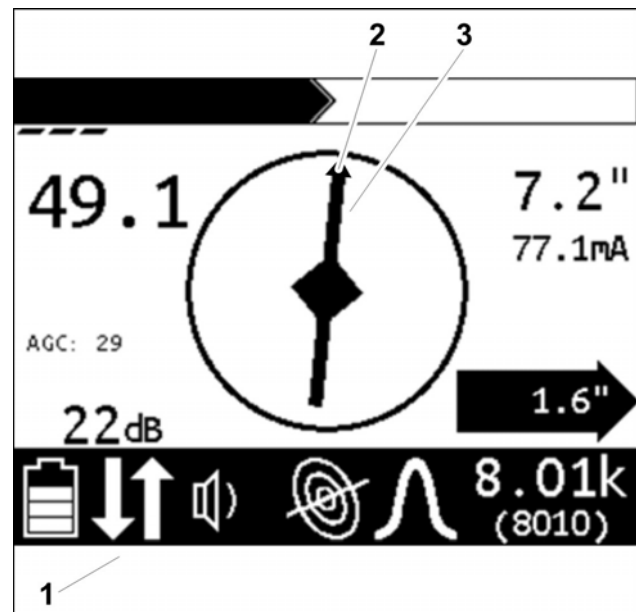

IMPORTANT:

- Power output is reduced when Direction Enable is in use.
- Direction Enable is not available when transmitter is set to High Output.

Offset Depth

Offset Depth assists in locating a target line that cannot be accessed from directly above due to obstruction. The function uses available data to estimate horizontal distance (X) and depth (D).

1. On the receiver menu, navigate to **Options>Offset Depth** and select 'Enable'.
 2. Begin by holding receiver parallel to line.
 3. Tilt receiver until center diamond (1) appears.
- Note:** Tilt of unit should be $>10^\circ$ and $<60^\circ$ (T) to display offset depth.
4. Read the estimated distance (2, X).

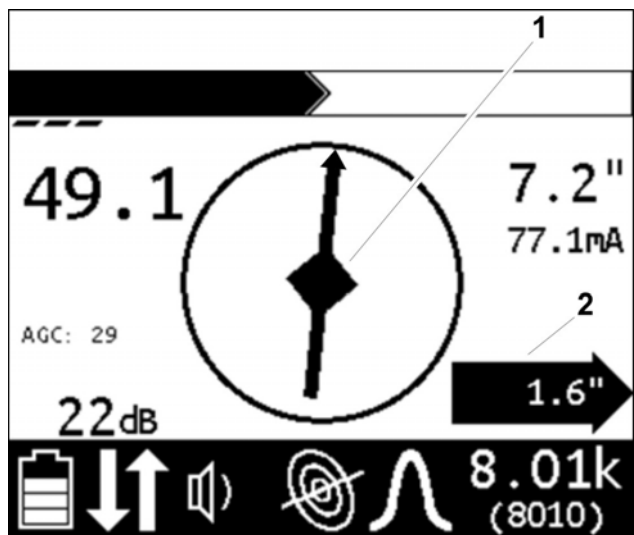
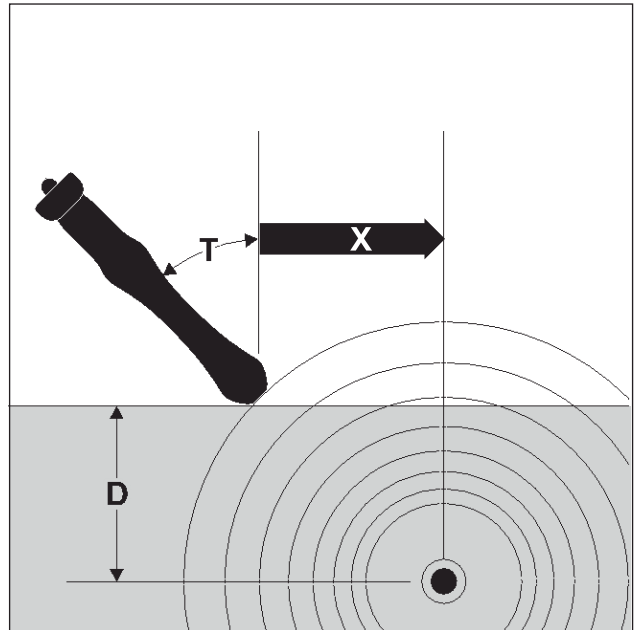



High Power Output

NOTICE: When using high power output, either install a Lithium ion battery pack or connect the transmitter to an external power source.

It allows the operator to transmit 12 watts on an active line at less than 10kHz and below. Use this function on large diameter direct buried steel pipe and long distance locates.

To activate:

1. Navigate the transmitter menu to **Settings>Output>High Power**.
2. Select 'Enable' or set timer as desired.

Mark the Cable

Sweep, focus, and trace all detected signals in the area. Mark cable paths with colored paint or flags. See the chart below for standard color markings for cable locations.

| Utility | Color | Marking Symbol |
|----------------|--------|----------------|
| electric | red | -E- |
| gas/oil | yellow | -G- |
| communications | orange | -TEL- or -TV- |
| water | blue | -W- |
| sewer | green | -S- |

Special Situations

| Situation | What to try |
|---|---|
| Signal is lost. | Walk in a circle to detect a tee or bend in the cable. |
| Signal varies from low to high and is unstable. | Mark as a hand-dig area. |
| You are near a power line and are receiving interference. | Sweep the area in 50 Hz or 60 Hz power mode. If receiver gives a strong signal response, a power line is interfering with transmitter signal. |
| Receiver does not function properly. | Receiver gain could be set too high or low. Lower or raise gain to locate the cable. See 'Controls' on page 15. |
| Target cable has connections to other cables. | Disconnect target cable from other cables or use direct connect or induction clamp to focus signal on target cable. |

| Situation | What to try |
|--|---|
| Signal is transferring to other cables | <ul style="list-style-type: none"> • Lower the frequency. • Lower the power level. • Use direct connection, if possible, or use induction clamp. • Move the ground stake away from the target cable and away from other buried cables. • Apply signal at the point where the target cable is farthest from the other cables. |

Locating cables with BIK probe

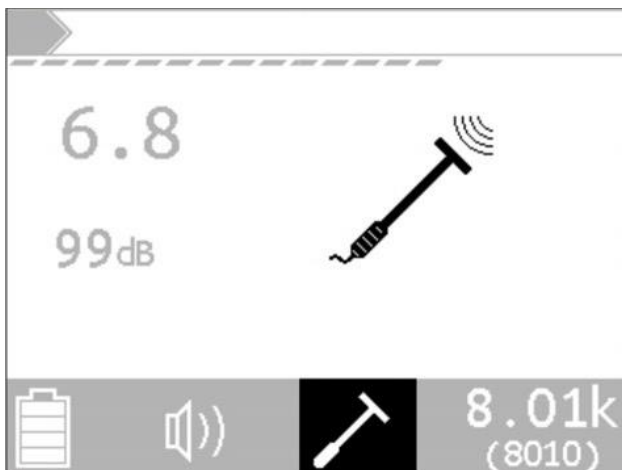

a) Target line
b) Head

1. Plug the probe cable into the accessory connector on the locator.
2. Turn on the locator. When stethoscope is plugged into locator. Locator will enter stethoscope mode. Stethoscope icon will show.
3. Use locator frequency key to select desired frequency. Use mode key to toggle between active and passive power frequencies.
4. Grip stethoscope by the handle and place the head as close to the target line as possible. Position the target line in the concave portion of the head as shown. Adjust flexible neck as needed to improve positioning.
5. Adjust the locator gain using the up and down arrow keys to bring the received signal strength into range.



Locate Passive Signal

Setup

Follow setup procedures for the type of locating you will be doing. Always check receiver battery level at startup. See 'Battery level' on page 22.

NOTICE: Cables with no A/C current flowing through them are hard to detect and may be hazardous because they may still have voltage potential. To locate, turn on an appliance to cause current to flow and use active search methods.

Technique

Survey the Site

Make a visual check of the site for signs of buried cables such as:

- recent trenching
- buried cable markers
- overhead lines that run down pole and underground
- gas meters
- valve sights
- drains or manhole covers

Sweep the Site

Search the site by walking a grid pattern while holding receiver close to the ground.

NOTE: Keep receiver vertical.

Focus the Signal

Move receiver over detected signal to find best signal response. If using a peak antenna mode, rotate receiver until signal is best. Best signal indicates cable direction.

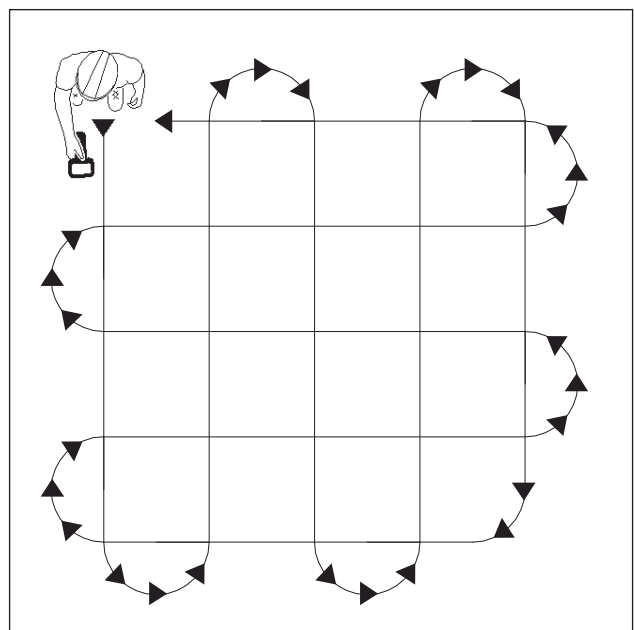

Trace the Cable

Walk along the suspected path while moving the receiver from side to side across the area.

IMPORTANT: Keep receiver handle parallel to the suspected cable path.

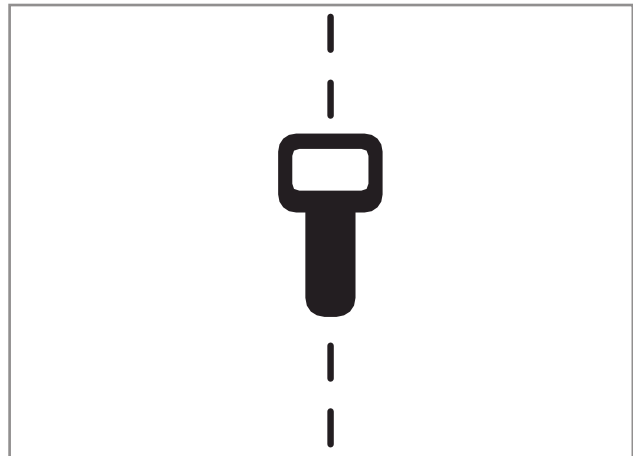

Mark the Cable

Sweep, focus, and trace all detected signals in the area. Mark cable paths with colored paint or flags. See the chart below for standard color markings for cable locations.

| Utility | Color | Marking Symbol |
|----------------|--------|----------------|
| electric | red | -E- |
| communications | orange | -TEL- or -TV- |

Special Situations

| Situation | What to try |
|---|---|
| Signal is lost. | Walk in a circle to detect a tee or bend in the cable. |
| Signal varies from low to high and is unstable. | Mark as a hand-dig area. |
| Receiver does not function properly. | Receiver gain could be set too high or low. Lower or raise gain to locate the cable. See 'Gain' on page 21. |



Locate Beacon Signal

Trace metallic pipes or conduits by locating and following a beacon signal.

IMPORTANT: Large metal objects and other signals (such as railroad signals or overhead power lines) will distort signal.

Setup

1. Follow instructions for installing beacon battery.
2. Turn on receiver to ensure that beacon is functioning properly.
3. Attach beacon to plumber's snake or flex rod.

Technique

1. Turn on receiver.
2. Set operating mode to Beacon location.
3. Set antenna configuration to Total Field.
4. Place beacon into the pipe and move it down the pipe.
5. Locate beacon:
Null Point Method: Circle over approximate location. Follow directional arrows (1, 3) to locate the null point (2). The beacon is correctly located at peak signal between null points.

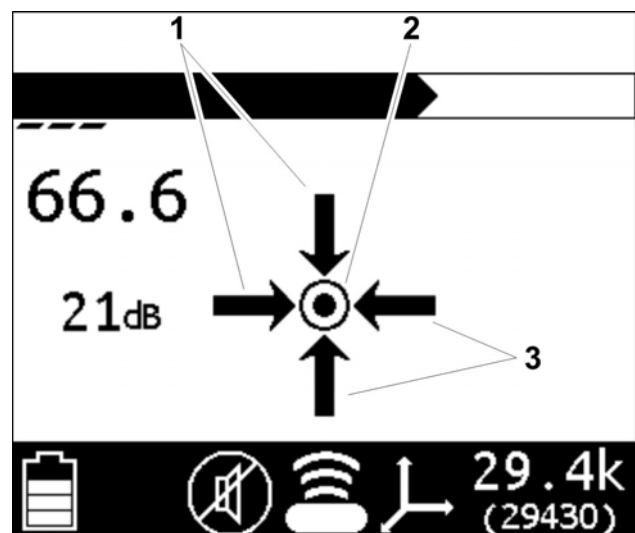
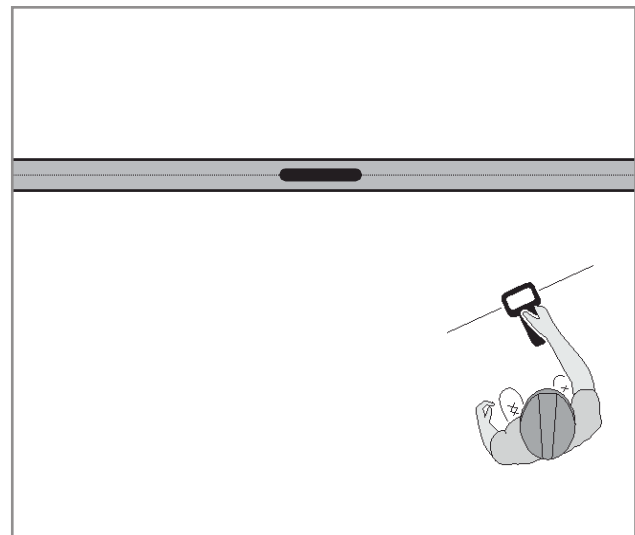

Peak Signal Method: When the peak signal is in range, rotation arrows will appear. Follow arrows (2) to rotate the receiver so that it is perpendicular to the beacon.

Follow fore/aft arrow (1) to locate the strongest signal response.

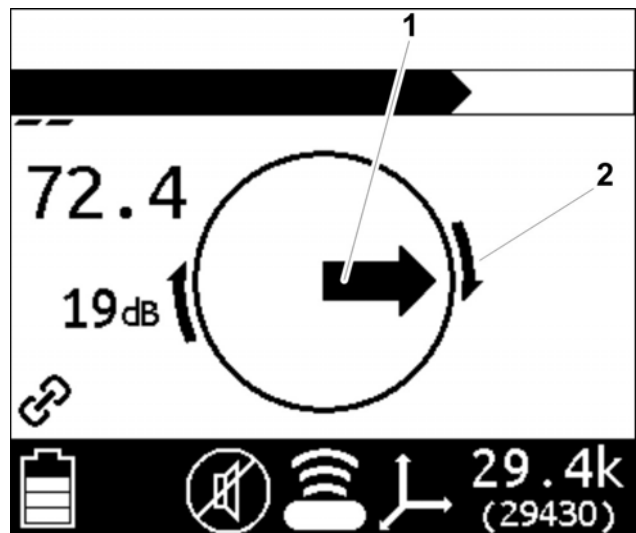
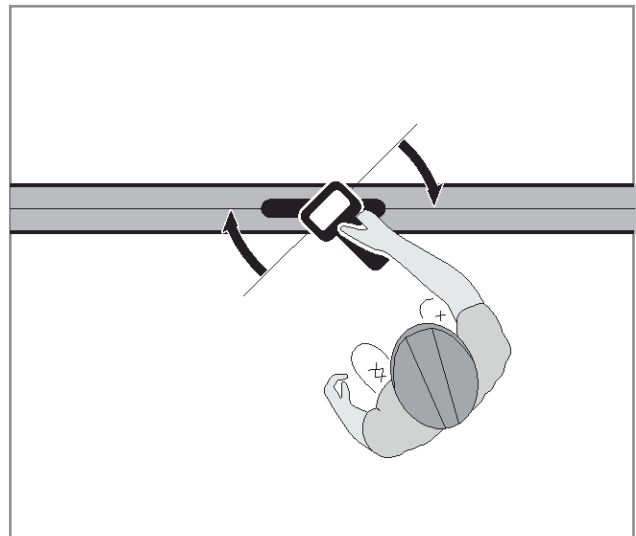

- 6. When the beacon is correctly located, a diamond (1) will form in the center of the compass, the exterior arrows (2) will appear, and the depth reading will display.
- 7. If operating in Manual depth, press the **Depth** key to estimate depth.

NOTICE: When estimating depth with a beacon in nonmetallic pipe, depth shown will be to the center of the beacon, not to the top of the pipe.

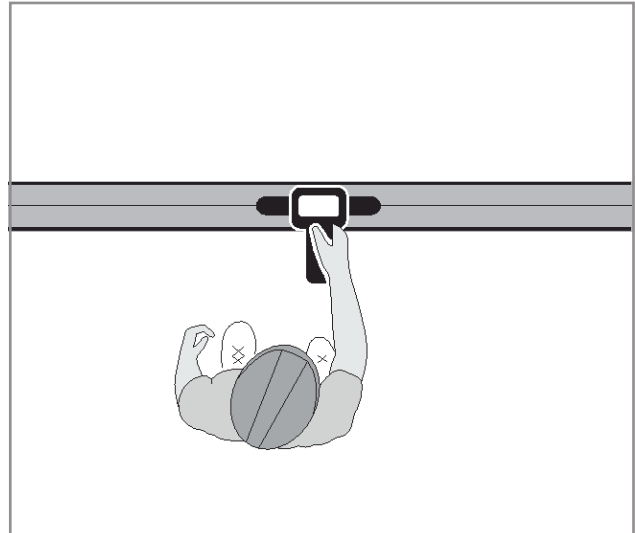

- 8. Continue to track the beacon and observe depth readings. Mark pipe location with paint.

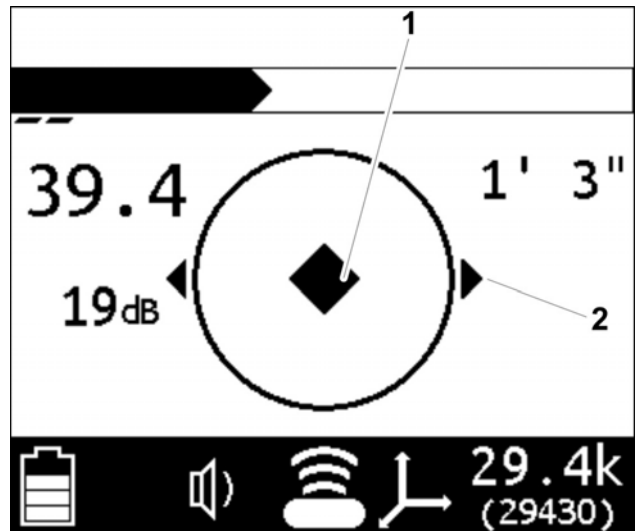

Common Signal Problems

Distortions in the electromagnetic field around a cable can affect location accuracy. Tees, bends, parallel cables, crossing cables, or large metallic objects can distort signals.

IMPORTANT: If target depth and location are critical, confirm by hand-digging or vacuum excavation.

Learn to recognize the following kinds of distortion:

Shadows

Shadows, also called blind spots, often happen when a metallic object partially obstructs the signal, or a signal from a parallel cable interferes with target signal.

Secondary (Ghost) Signals

A typical beacon signal pattern shows a main signal and two weaker secondary signals. Identify beacon location at the main signal. Familiarity with beacon signal patterns will lessen the effect of ghost signals. Using the Total Field antenna mode will eliminate ghost signals. See 'Select Antenna Configuration' on page 27.

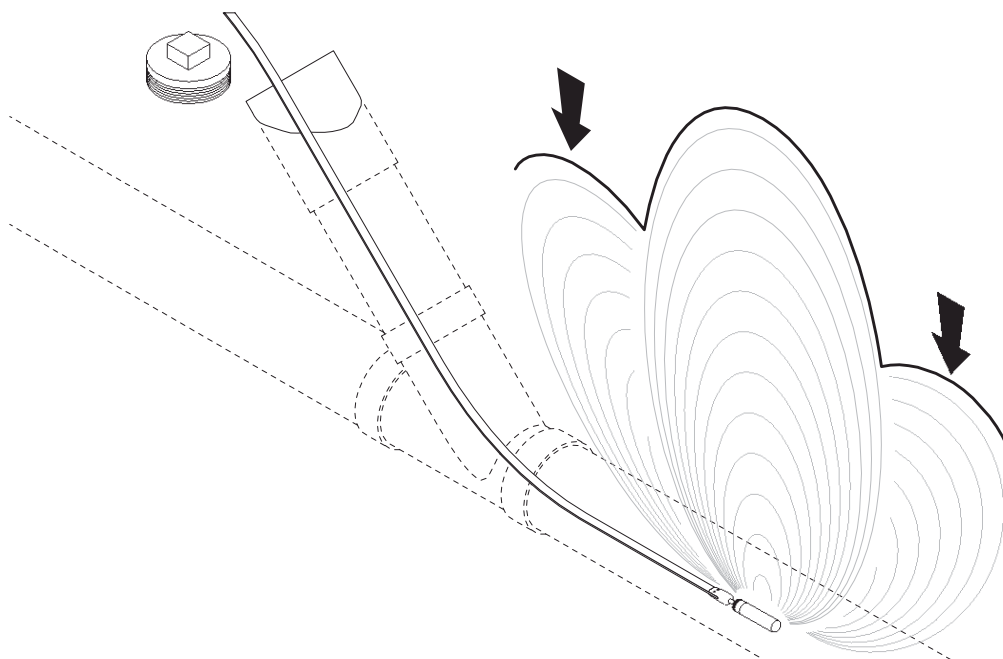

Service

Chapter Contents

| | |
|---------------------|-----------|
| General Care | 46 |
| As Needed | 46 |

General Care

Under normal operating conditions, receiver, transmitter and A-frame detector need only minor maintenance. Following these care instructions can ensure longer equipment life:

- Do not drop the equipment.
- Do not expose the equipment to high heat (such as in the rear window of a vehicle).
- Clean equipment with a damp cloth and mild soap. Never use scouring powder.
- Do not immerse in any liquid.
- Inspect housing daily for cracks or other damage. If housing is damaged, contact your equipment dealer for replacement.
- Do not mix new and used batteries.

As Needed

| Location | Task | Notes |
|------------------|------------------|-----------------|
| Receiver Unit | Change batteries | 2 "D" alkaline |
| Transmitter Unit | Change batteries | 10 "D" alkaline |

Locate Passive Signal

Change Batteries

Use 2 D-cell alkaline batteries in receiver.

1. Remove battery cover.
2. Insert batteries as shown.
3. Install and tighten battery cover.
4. Check operation.

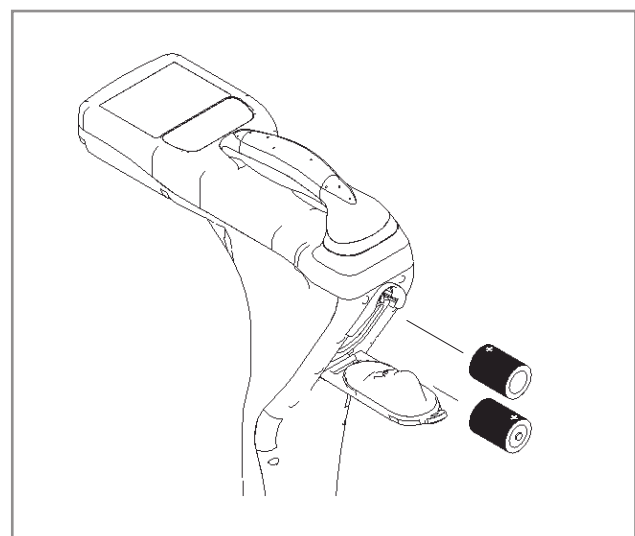

Transmitter Unit

Change Batteries

Use ten D-cell alkaline batteries or a Lithium-ion battery pack in transmitter.



⚠ WARNING Battery cells inside may vent or rupture. Do not crush, do not heat or incinerate, do not short circuit, do not dismantle, do not immerse in any liquid. Observe charging instructions.

To help avoid injury, see battery manufacturer's safety instructions.

1. Open battery cover.
2. Insert batteries as shown.

IMPORTANT:

- Installing batteries backwards will cause damage to batteries and unit.
- Ensure that door is closed tightly.
- Do not mix new and used batteries.

3. Close and tighten battery cover.
4. Check operation. If battery light is flashing when unit is turned on, then one battery is incorrectly installed or batteries are weak.

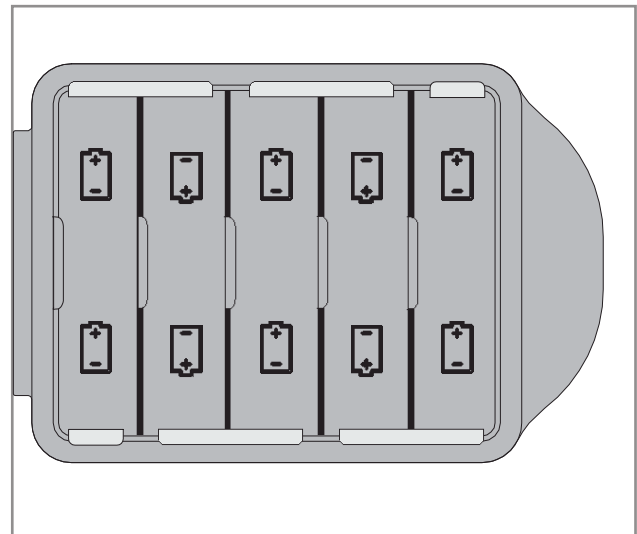

Update Software

The manufacturer updates software periodically to fix bugs and improve functionality. These updates are accessible through web-based software available with this product.

To install updates:

1. Use a USB cable to connect the unit to a personal computer.
2. Launch the software and follow prompts to install updates.

Refer to the software application for more information.

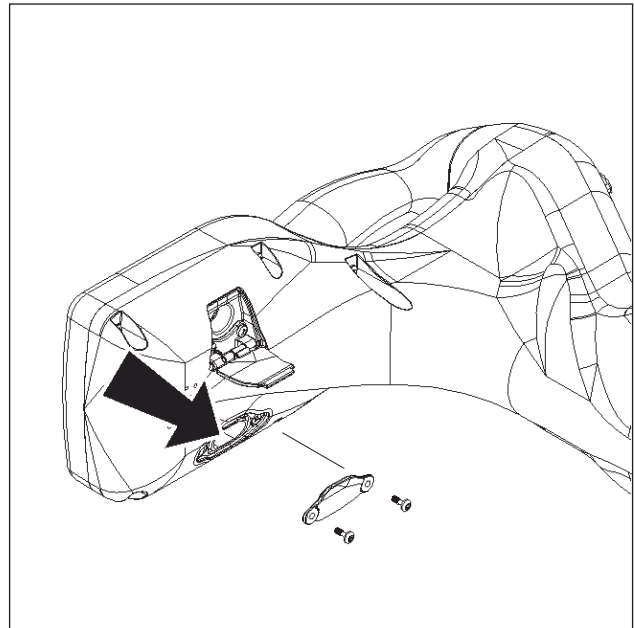

Specifications

Receivers

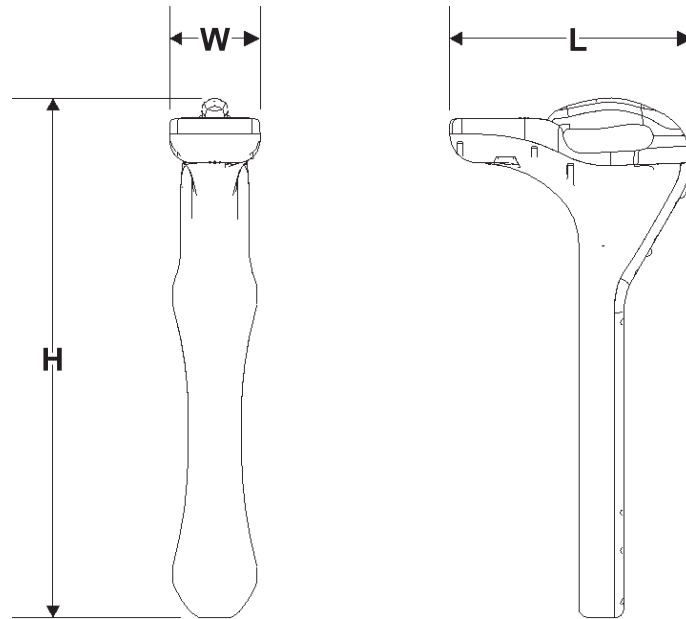

| Dimensions | U.S. | Metric |
|------------|--------|----------|
| H Height | 27.2" | 69.09 cm |
| L Length | 12.8" | 32.50 cm |
| W Width | 4.8" | 12.19 cm |
| Weight | 4.8 lb | 2.18 kg |

| Operation | U.S. | Metric |
|---|---------------|---------------|
| Operating temperature range | -4°F to 122°F | -20°C to 50°C |
| Antenna configurations: single peak, twin peak, null, left/right (cable only) | | |
| Audio output: speaker | | |
| LCD backlight: LED | | |
| External ports: Mini USB | | |

| Batteries |
|--|
| Type: 2 D-cell alkaline |
| Life (intermittent use at 70°F/21°C): approximately 30 hours |

Battery saver: unit shuts off after 5 minutes of inactivity

Transmitters

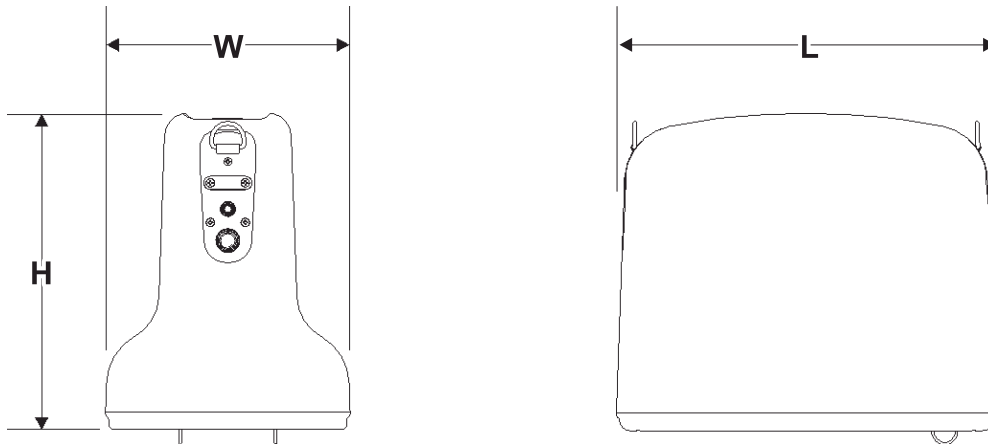

| Dimensions | U.S. | Metric |
|------------|--------|----------|
| H Height | 10" | 25.40 cm |
| L Length | 12" | 30.48 cm |
| W Width | 7.8" | 19.1 cm |
| Weight | 7.8 lb | 3.54 kg |

| Operation | U.S. | Metric |
|---|---------------|---------------|
| Operating temperature range | -4°F to 122°F | -20°C to 50°C |
| Maximum power output: 12 watts | | |
| Standard operating frequency: Over 70 frequencies. | | |
| Timer: unit runs continuously or shuts off after running for a selected hour interval (8-hour maximum). | | |

| Batteries |
|--|
| Type: 10 D-cell alkaline or 1 Lithium ion battery pack |
| Life (continuous use at power level 2): Alkaline - approximately 100 hours; Li approximately 80 hours. |

System Operation

| Operating Modes and Frequencies |
|---|
| Active cable, standard: Over 70 frequencies |
| Passive cable, standard: 60 Hz, 120 Hz, 180 Hz, 50 Hz, 100 Hz, 150 Hz |
| Beacon, optional (locate/depth only): any frequency. |
| Radio |
| Fault finding: signal is compatible with A-Frame accessory |

| Locating Ranges | U.S. | Metric |
|-----------------|------|--------|
| Cables | 15' | 4.6 m |
| Beacons | 10' | 3 m |

| Depth Estimate Tolerances* | U.S. | Metric |
|----------------------------|---------|----------|
| Passive cable $\pm 10\%$ | 0.5-10' | 0.15-3 m |
| Active cable $\pm 5\%$ | 0.2-10' | 0.2-3 m |
| Beacon $\pm 5\%$ | 0.5-10' | 0.15-3 m |

* Locators are calibrated to these tolerances under ideal test field conditions. Actual operating field conditions may have signal distortions or may contain noise sources which result in depth range that is less than specified.

Support



Procedure

Notify your dealer immediately of any malfunction or failure of SONEL S.A. equipment.

Always give model, serial number, and approximate date of your equipment purchase. This information should be recorded and placed on file by the owner at the time of purchase.

Return damaged unit to dealer for inspection and warranty consideration if in warranty time frame. All repairs must be done by an authorized SONEL S.A. repair facility. Repairs done elsewhere will void warranty.

Electronics Limited Warranty Policy

Subject to the limitation and exclusions herein, free replacement parts and labor will be provided when a unit fails due to a defect in material or workmanship within one (1) year of first commercial use (See Exceptions below for specific products). Defects shall be determined through inspection by Manufacturer or authorized repair centers. An inspection must occur within thirty (30) days of the date of failure of the product or part by Manufacturer or its authorized repair facility. Manufacturer will provide the location of its inspection facilities or its nearest authorized dealer upon inquiry. Manufacturer reserves the right to supply remanufactured replacement parts under this warranty as it deems appropriate. Each warranty repair carries the remainder of the factory warranty or 90 days, whichever is longer, for all repaired components and labor.

Operating instructions for A-Frame

Description

Causes of a ground fault

When the insulation of a buried cable is damaged, the conductor is at risk of direct contact with the ground, which may cause a short circuit. This type of defect is called a ground fault. This kind of damage excludes damaged cable from use, causing interruptions in electricity supply and may result in immediate danger of electric shock. In such conditions, new short circuits may be generated between the damaged cable and ground, resulting in additional corrosion, which may further deteriorate the situation.

Short circuits may be caused by a number of factors.

- **Improper connections:** poorly made cable boxes
- **Mechanical damage:** cables may be cut or broken by excavation equipment, e.g. by excavators, drills, augers, shovels, fence posts or even compactors. Areas affected by this kind of works may cause a ground fault and initiate corrosion.
- **Abrasion:** rocks and other aggregates may damage the cable during landslides.
- **Weather conditions:** lightning strikes.
- **Defects at the production stage:** gas inclusions, heterogeneity of the insulation.

IMPORTANT: Although there are other types of damage, this device is designed to detect only ground faults!

Location of cable damage resulting in ground fault

Guidelines for locating damaged cable. Pay attention to the following factors:

- recent earthworks
- newly made connections / cable boxes
- information about new/current roadworks
- underground utilities
- junction boxes
- street lighting
- sunken areas

Information about locating damages

In order to detect a ground fault, disconnect the power supply and insulate the ends of the cable, then connect the damaged cable electrically to LKN-2000 transmitter, which will generate a signal with a frequency of 263 Hz; this will create an electrical circuit in which the current flows along the cable and searches a path to return to the transmitter. The return path to the transmitter is along the path of the ground fault. The current will not flow without grounding the black conductor using the supplied probe. Locating the damage is more difficult in sandy and dry soil than in humid soil (e.g. after the rain).

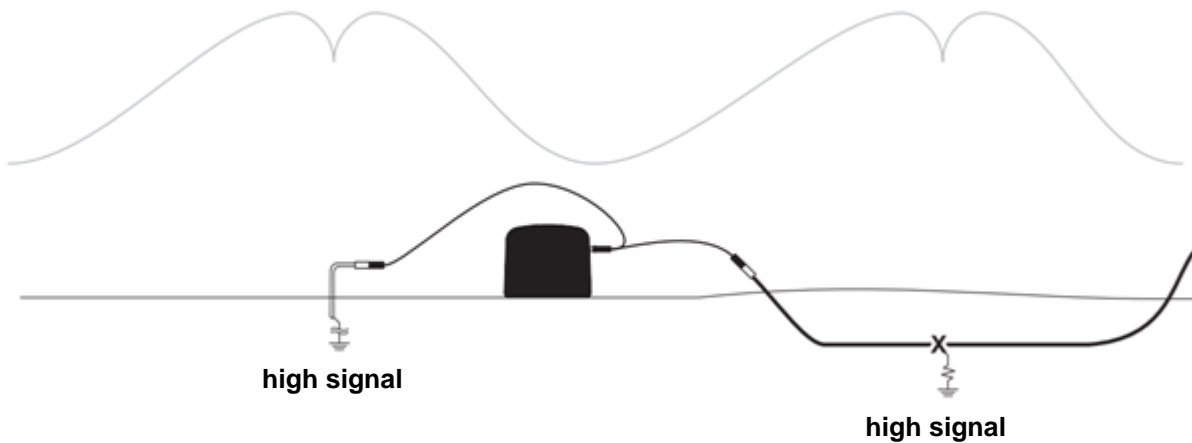

By using A-frame, you may determine the exact location of current leakage from a damaged cable. The signal will be highest at the point of damage, where the current penetrates the ground and near the grounding probe of the transmitter. The arrows on the receiver, after connecting A-frame, will indicate the direction of cable damage.



As you move away from the transmitter, the receiver may stop displaying the transmitter signal. When you approach the damage, the receiver will resume displaying the signal from the transmitter. This is normal. The signal will be strongest in the vicinity of the fault (X) and close to the grounding of the transmitter. When the probes of A-frame are in the same distance on each side of a ground fault or transmitter grounding, the signal disappears.

Operation of the transmitter

1. Turn off the power supply and insulate the cable at both ends (it cannot be grounded). Disconnecting with the switch is generally insufficient to insulate the cable for fault location.
2. Connect the provided cable to the transmitter.
3. Connect the red alligator clip to the damaged line (in case of multi-conductor cables: connect all the conductors), and the black alligator clip to the grounding probe.
4. Press On/Off button, to turn on the transmitter.

5. Press and hold Power Level button , to enter the menu.
6. Go down „f-„ to Menu options and press Power Level button in "Options", to select the operating mode.
7. Go down to A-frame mode and press Power Level button , to make the selection.

IMPORTANT: When cables are not connected to the transmitter, A-frame mode will not be displayed in the menu.

8. Select "Active" by pressing the Power Level button .
9. The transmitter will return to the main screen and will be in A-frame mode.

After connecting the transmitter to the cable, the impedance readings will help to verify whether the cable is damaged. When the transmitter is in A-frame Mode, the screen will display the current, impedance and voltage values. The power level will be 1 (on a 5-point scale). If the current value drops below 5 mA, increase the power level until the display shows the minimum value of 5 mA.

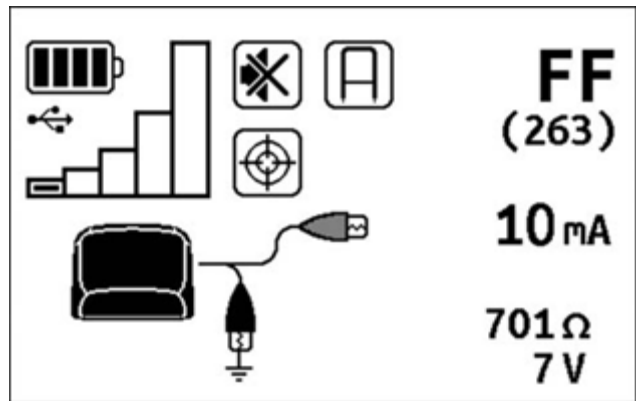

- Readings > 100kΩ indicate that the cable is not seriously damaged.
- Readings < 50kΩ indicate that damage is likely.
- Higher power levels of the transmitter provide better readings. Try to use a higher power level to make sure that the cable is damaged.

Setting the transmitter and A-Frame

Important:

- If the frequency of 263Hz is not activated in the receiver, fault detection with A-frame will be disabled.

1. Press On/Off button, to turn on the receiver.
2. Connect A-frame to the socket of LKO-2000 receiver, which is at the opposite side of the screen, under a flap.
3. When A-frame is connected to the receiver, the receiver automatically enters the fault mode (A-frame symbol is displayed) and displays "house" symbol in the lower right corner of the location - as shown in the figure.
4. Connect the transmitter to the damaged line, following the instructions for handling the transmitter.
5. Select power level 1 or 2 on the transmitter, paying attention to the corresponding current in the cable (preferably at least 10mA).
6. Stand with your back to the transmitter and the grounding probe, facing the suspected direction of the damage.
7. Then drive A-frame exactly over the cable, to align the probes along the cable.
8. Values indicating signal strength will be displayed above blinking "house" icon. Then press and hold Frequency button "f" to make the fault detection system return to the initial settings; this operation allows you to determine the side from which the reference signal is coming (fault location).
9. If the signal is sufficient, the receiver will indicate the direction from which the signal is coming (as shown



in figure). This indicates that the damage is located in front of you.

IMPORTANT: During the detection process, A-frame and the receiver should face the same direction (shown by the arrow on A-frame and the receiver).

Finding faults

Known cable route

After determining the direction of the damage, LKO-2000 receiver will display strength and direction of the signal if the signal is strong enough. If not, increase the power of the transmitter and repeat the steps described in section "Setting the transmitter and A-frame". If the signal is not detected, the detector will display "- -" in the middle of the screen.

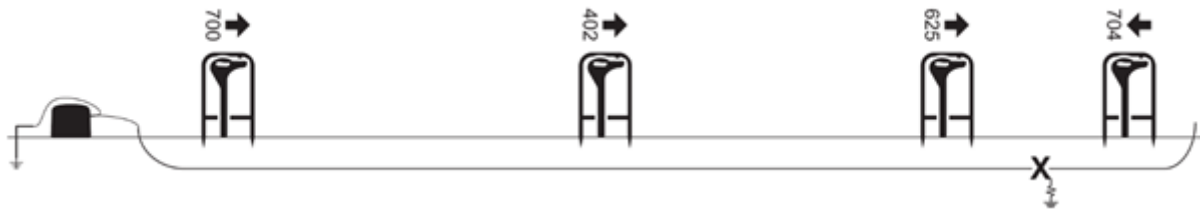

1. Move 3 meters along the cable route and again drive A-frame into the ground.
2. When the arrows indicate the opposite directions, take a step back and drive again A-frame into the ground.
3. Repeat step 2, moving on shorter distances, until the arrow changes its direction after moving only by a few centimeters. The location where the movement of the A-frame changes the direction of the incoming signal is the place of the damage (between probes of A-frame).
4. Turn A-frame by 90° and repeat the location procedure, until the arrow changes its direction after a slight movement. Damage is located directly between the probes.

Unknown cable route

IMPORTANT: If possible, locate the cable route earlier using the receiver and mark its location. Then, follow the instructions valid for the known route of the cable.

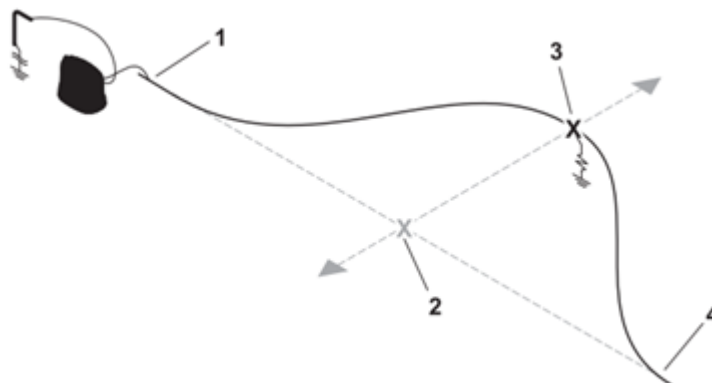

1. Draw a straight line between the two disconnected ends (1, 4) of the insulated cable.
2. Follow the instructions in "Known cable route" (above).
3. After detecting the fault (2) at the straight line, turn the probe by 90° and find the actual location of the damage (3).